

THE APOLLO SPACECRAFT

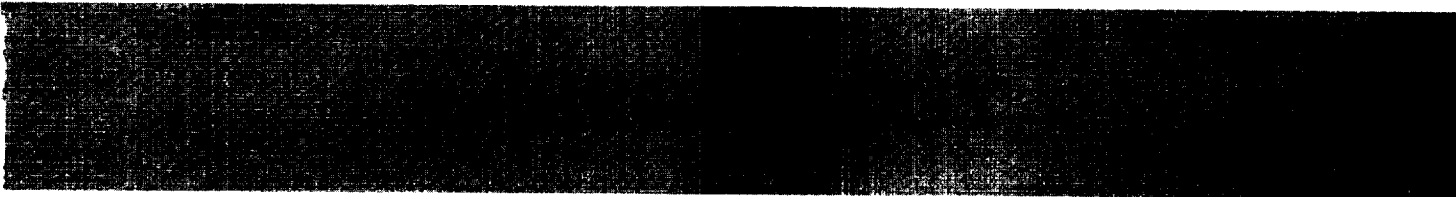

VOLUME IV

January 21, 1966-July 13, 1974

by
Ivan D. Ertel and Roland W. Newkirk
with
Courtney G. Brooks



Scientific and Technical Information Office

NATIONAL AERONAUTICS AND SPACE ADMINISTRATION

1978
Washington, D.C.

Library of Congress Cataloging in Publication Data (revised)

Main entry under title:

The Apollo spacecraft.

(The NASA historical series) (NASA SP-4009)

CONTENTS: v. 1. Ertel, I. D. and Morse, M. L. Through Nov. 7, 1962.—v. 2. Morse, M. L. and Bays, J. K. Nov. 8, 1962-Sept. 30, 1964. [etc.]

Includes bibliographical references.

I. Project Apollo. I. Ertel, Ivan D., 1914- II. Title. III. Series: United States. National Aeronautics and Space Administration. NASA historical series. IV. Series: United States. National Aeronautics and Space Administration. NASA SP-4009.

TL789.8.U6A5135

629.47

69-60008

For sale by the Superintendent of Documents,
U.S. Government Printing Office, Washington, D.C. 20402
Stock Number 033-000-00732-9
Library of Congress Catalog Card Number 69-60008

FOREWORD

This fourth and final volume of the Apollo Spacecraft Chronology covers a period of eight and a half years, from January 21, 1966, through July 13, 1974. The events that took place during that period included all flight tests of the Apollo spacecraft, as well as the last five Gemini flights, the AS-204 accident, the AS-204 Review Board activities, the Apollo Block II Redefinition Tasks, the manned Apollo flight program and its results, as well as further use of the Apollo spacecraft in the Skylab missions.

The manned flights of Apollo, scheduled to begin in early 1967, were delayed by the tragic accident that occurred on January 27, 1967, during a simulated countdown for mission AS-204. A fire inside the command module resulted in the deaths of the three prime crew astronauts, Virgil I. Grissom, Edward H. White II, and Roger B. Chaffee. On January 28, 1967, the Apollo 204 Review Board was established to investigate the accident. It was determined that action should be initiated to reduce the crew risk by eliminating unnecessary hazardous conditions that would imperil future operations. Therefore, on April 27, a NASA Task Team—Block II Redefinition, CSM—was established to provide input on detailed design, overall quality and reliability, test and checkout, baseline specification, configuration control, and schedules.

Months of scrutinizing and hard work followed. The testing of the unmanned spacecraft began with the successful all-up test launch and recovery of the Saturn V-Apollo space system on November 9, 1967. This flight, designated *Apollo 4*, marked the culmination of more than seven years of developmental activity in design, fabrication, testing and launch-site preparation by tens of thousands of workers in government, industry and universities. The unmanned *Apollo 4* placed 126 000 kilograms in earth orbit. It accomplished the first restart in space of the S-IVB stage; the first reentry into the earth's atmosphere at the speed of return from the moon, nearly 40 200 kilometers per hour; and the first test of Launch Complex 39.

As time for the first manned Apollo flight neared, a decision was reached to use a 60-percent-oxygen and 40-percent-nitrogen atmosphere in the spacecraft cabin while on the launch pad and to retain the pure oxygen environment in space. By March 14, 1968, testing of the redesigned interior of the vehicle demonstrated that hardware changes inside the cabin, minimized possible sources of ignition, and materials changes had vastly reduced the danger of fire propagation.

During the beginning of the period covered by this chronology (from March through November 1966) the last five Gemini spacecraft were flown. The objectives of the Gemini program that were applicable to Apollo included: (1) long-duration flight, (2) rendezvous and docking, (3)

postdocking maneuver capability, (4) controlled reentry and landing, (5) flight- and ground-crew proficiency, and (6) extravehicular capability. The prelaunch checkout and verification concept as originated during the Gemini program was used for Apollo. The testing and servicing tasks were very similar for both spacecraft. Although complexity of the operations substantially increased, the mission control operations for Apollo evolved from Projects Mercury and Gemini. The medical data collected during the Gemini flights verified that man could function in space for the planned duration of the lunar landing mission. Many of the concepts for crew equipment—such as food and waste management, housekeeping, and general sanitation—originated from the Gemini experience with long-duration missions. The Gemini missions also provided background experience in many systems such as communications, guidance and navigation, fuel cells, and propulsion.

While the Mercury and Gemini spacecraft were being developed and operated, the three-man Apollo program had grown in magnitude and complexity and included a command module, a service module, a lunar module, and a giant Saturn V rocket. The spacecraft and launch vehicle towered 110 meters above the launching pad, and weighed some 3 million kilograms. With the Apollo program, the missions and flight plans had become much more ambitious, the hardware had become more refined, the software had become more sophisticated, and ground support equipment also grew in proportion.

In October 1968 *Apollo 7* became the first manned flight test of the Apollo command and service modules in earth orbit and demonstrated the effectiveness of the manned space flight tracking, command and communications network. This first mission was a rousing success, with all systems meeting or exceeding requirements.

The second Apollo flight was the much-publicized *Apollo 8* mission in December 1968, during which man for the first time orbited the moon. Aside from the fact that the flight marked a major event in the history of man, it also was technically a remarkable mission. The purpose of the mission, to check out the navigation and communication systems at lunar distance, was accomplished with a complete verification of those systems.

Apollo 9 (March 1969) was an earth-orbital flight and included the first engineering test of a manned lunar module and the first rendezvous and docking of two manned space vehicles.

In May 1969 *Apollo 10* journeyed to the moon and completed a dress rehearsal for the landing mission to follow in July. This mission was designed to be exactly like the landing mission except for the final phases of the landing, which were not attempted. The lunar module separated from the command module and descended to within 15 kilometers of the lunar surface, proving that man could navigate safely and accurately in the moon's gravitational field.

With the flight of *Apollo 11*, man for the first time stepped onto the lunar surface on July 20, 1969. The mission proved that man could land on

FOREWORD

the moon, perform specific tasks on the lunar surface, and return safely to earth.

Apollo 12 (November 1969) was the second manned lunar landing. Pieces from the unmanned *Surveyor III* spacecraft were recovered, and the first Apollo Lunar Surface Experiments Package (ALSEP) was deployed.

Apollo 13 (April 1970) had been scheduled to be the third manned lunar landing. However, the lunar landing portion of the mission was aborted because of the explosion of an oxygen tank in the service module en route to the moon. A cislunar mission was accomplished and the lunar module was used to provide life support and propulsion for the disabled command and service module en route home. A safe return and landing was effected in the Pacific.

Apollo 14 (January-February 1971) successfully landed on the lunar surface, with the crew performing two extravehicular activities (EVAs), deploying the second Apollo Lunar Surface Experiments Package, and completing other scientific tasks with the aid of a rickshawlike mobile equipment transporter (MET). The crew remained on the lunar surface 33½ hours.

The fourth manned lunar landing, *Apollo 15* (July-August 1971), was the first mission to use the Lunar Rover, the first to deploy a subsatellite in lunar orbit, the first to perform experiments in lunar orbit by using a scientific instrument module (SIM) in the service module, and the first to conduct extravehicular activity during the journey back to earth. Lunar stay time was 66 hours and 55 minutes.

Apollo 16 (July 1972), the fifth manned lunar landing, was essentially identical to *Apollo 15* and configured for extended mission duration, remote sensing from lunar orbit, and long-distance surface traverses. The scientific instrument module was included in the service module.

The splashdown of *Apollo 17* on December 19, 1972, not only ended one of the most perfect missions, but also drew the curtain on the manned flights of Project Apollo. It was the most ambitious moon probe, the longest moon mission—about 40 hours longer than *Apollo 16*, with 75 hours on the lunar surface from touchdown to liftoff. The extensive scientific exploration utilized a new generation of experiments. The crew traversed from the LM farther than ever before, traveling 32 kilometers in the Lunar Rover.

Although *Apollo 17* was the last of the manned flights to the moon, it was not the last of the Apollo spacecraft. Apollo paved the way for missions to follow. The next program using an Apollo command module was Skylab (May 14, 1973-February 8, 1974), occurring within the time frame of this chronology, as studies of lunar samples and data returned from Project Apollo continued in laboratories throughout the world. Skylab was man's most ambitious and organized scientific probing of his planet and proved the value of manned scientific space expeditions. Skylab proved man's value in space as a manufacturer, an astronomer, and an earth observer, using the most sophisticated instruments in ways that unmanned satellites cannot match. Skylab also demonstrated man's great utility as a repairman in space.

Detailed studies of man's physiological responses to prolonged exposure to weightlessness proved his ability to adjust to the space environment and to perform useful and valuable work in space. In solar physics, Skylab enriched our solar data more than a hundredfold, with a total of some 200 000 photographs of the sun made from the Apollo Telescope Mount. As observers of earth resources from Skylab, the crews returned over 40 000 photographs and more than 60 kilometers of high-density magnetic tape. Data were acquired for all 48 continental United States and 34 foreign countries.

Beyond the period covered by this chronology, but before its publication, the Apollo spacecraft was used again in the Apollo-Soyuz Test Project (ASTP), July 15-24, 1975. This joint space flight culminated in the first historical meeting in space between American astronauts and Soviet cosmonauts. The event marked the successful testing of a universal docking system and signaled a major advance in efforts to pave the way for joint experiments and mutual assistance in future international space explorations. There were some 44 hours of docked joint activities during ASTP, highlighted by four crew transfers and the completion of a number of joint scientific experiments and engineering investigations. All major ASTP objectives were accomplished, including testing a compatible rendezvous system in orbit, testing androgynous docking assemblies, verifying techniques for crew transfers, and gaining experience in the conduct of joint international flights.

We will continue to apply what we learned from Apollo, as well as Skylab and ASTP, as we venture into the next manned program, known as the Space Shuttle. The Shuttle will be another leap forward. It will be the first reusable space vehicle. It will consist of three components: solid rocket boosters, a jettisonable external propellant tank, and an orbiter. The Space Shuttle will be launched like a rocket, fly in orbit like a spaceship, and land like an airplane. These vehicles are being designed to last for at least a hundred missions. The reusability will reduce the cost of putting men and payloads in orbit to about 10 percent of the Apollo costs.

In this chronology, as with any collection of written communications on a given project, the negative aspects of the program, its faltering and its failures, become more apparent because these are the areas that require written communication for corrective action. However, it should be stressed that in spite of the failures, the moon was reached by traveling an unparalleled path of success for an undertaking so complex. The disastrous fire at Cape Kennedy had given the Apollo program a drastic setback. But when *Apollo 7* was launched, the first manned flight in nearly two years, it was a success. Every spacecraft since that time improved in performance with the exception of the problems experienced in *Apollo 13*. For example, consider the *Apollo 8* spacecraft and booster, which contained some 15 million parts. If those parts had been 99.9 percent reliable, there still would have been 15 000 failures. But it had only five failures, all in noncritical parts.

FOREWORD

To summarize Project Apollo—there were 11 manned flights; 27 Americans orbited the moon; 12 walked on its surface; 6 drove lunar vehicles. Perhaps one of the most important legacies of Apollo to future programs is the demonstration that great successes can be achieved in spite of serious difficulties along the way.

No other event in the history of mankind has served to bring the peoples of the world closer together than the lunar landings of Project Apollo. This feeling of “oneness” was fully displayed during the flight of *Apollo 13* when many nations of the earth offered assistance in recovering the voyagers from their crippled spacecraft. From nearly every country came prayers and words of encouragement. The crippling of the *Apollo 13* spacecraft en route to the moon called forth maximum cooperative use of the ability of astronauts, the ground support organization, and the contractors. The men and the equipment they designed and operated proved capable of handling this emergency.

Besides the demonstration of the power of teamwork, many areas of understanding have come out of the lunar landing program. The command and service modules on the last three lunar missions carried some 450 kilograms of cameras, sophisticated remote-sensing equipment, and additional consumables to investigate the moon thoroughly from orbit. Detailed studies of the moon were accomplished—of its size, shape, and surface, and the interrelationship of the lunar surface features and its gravitational field. On the surface of the moon, where there is no atmosphere to erode, secrets were uncovered that have long since been worn away here on earth. Understanding the geology of the moon improves the understanding of our own planet.

Twelve men, who spent a total of 296 hours exploring the lunar surface in six radically different areas, mined 382 kilograms of lunar rocks and material. Scientists have catalogued, distributed, and analyzed this lunar material. Much of the real discovery is still being unraveled in laboratories around the world.

Five lunar science stations, originally designed to last a minimum of a year, are still at work on the lunar surface, continuing to transmit to earth technical data about the moon.

The national space program became an example of a successful management approach to accomplish an almost impossible project. The task of going to the moon required a government, industry, and university team which, at its peak, organized 400 000 people, hundreds of universities, and 20 000 separate industrial companies for a common goal. This project was accomplished in full public view of the world. These management techniques are available to our country to use again on what are considered almost impossible tasks.

The Apollo photographs of the entire earth in one frame have made us realize how small and finite and limited are the resources of spaceship Earth. Apollo not only brought home to us more clearly the problems we must face in protecting this tiny planet, but it also suggested solutions. As we now

turn some of our attention to such problems as mass transportation, pollution of our atmosphere and our fresh water resources, urban renewal, and utilization of new power sources, the same management approach, techniques, and teams that landed men on the moon can combine to help solve these kinds of problems. The photographs of our earth taken by astronauts on Gemini, Apollo, Skylab, and ASTP have clearly demonstrated that we can make ecological surveys from space in geography, in agriculture and forestry, geology, hydrology, and oceanography. We can update maps, study pollution, predict floods, and help locate our natural resources and good commercial fishing grounds. We have only scratched the surface in the application of space technology.

The Apollo spacecraft not only made history, but laid a great foundation of hope for a better future. The really important benefits are yet to be derived, for we have merely cracked open the door to a completely new laboratory in which to pursue knowledge.

October 1975

Kenneth S. Kleinknecht
Director of Flight Operations
Johnson Space Center

CONTENTS

	PAGE
FOREWORD	iii
LIST OF ILLUSTRATIONS	x
PREFACE	xiii
PART I: PREPARATION FOR FLIGHT, THE ACCIDENT, AND INVESTIGATION	1
PART II: RECOVERY, SPACECRAFT REDEFINITION, AND THE FIRST MANNED FLIGHT	115
PART III: MAN CIRCLES THE MOON, THE EAGLE LANDS, AND MANNED LUNAR EXPLORATION	263
APPENDIXES	
1. Glossary of Abbreviations and Acronyms	367
2. Major Spacecraft Component Manufacturers	372
3. Official U.S. IAF World Records	373
4. Flight Summary	377
5. Primary Apollo Flight Objectives	401
6. Crews and Support for Manned Apollo Flights	408
7. Funding	410
8. Block II vs. Block I Apollo Spacecraft	413
9. Apollo Experiments	420
10. Organization Charts	427
INDEX	439

LIST OF ILLUSTRATIONS

All photographs and illustrations are furnished by the U.S. Government except as credited. Persons in the photos are identified in the captions and included in the index.

PART I

	PAGE
Mating of launch escape system and spacecraft 009	10
One-sixth-g simulator	11
Space Environment Simulation Chamber cutaway	13
Cutaway view of Vehicle Assembly Building	23
First full-scale rollout of Apollo-Saturn V	23
F-1 rocket engines installed	35
F-1 rocket engine firing	35
F-1 thrust chamber manufacturing line	43
Apollo spacecraft flotation test	45
AS-204 altitude chamber test	51
LM ascent stage in thermal vacuum chamber	51
Apollo egress training	53
Command module 012 after AS-204 fire	64
Most probable area of origin of Apollo 204 fire	111

PART II

CM wire harness manufacturing	121
“Tiger Team” results	135
X-ray inspection	141
LM-1	153
CM unified hatch	154
<i>Apollo 4</i> recovery	173
Apollo Mission Simulator	197
<i>Apollo 6</i> liftoff	216
CSM 2TV-1 checkout	221
CM 101	233
Block II CSM cutaway view	248
AS-503 rollout	255
<i>Apollo 7</i> activities	258,259

LIST OF ILLUSTRATIONS

PART III

Earth-rise over lunar horizon	276
<i>Apollo 8</i> recovery	276
Slide-wire training	280
KSC Firing Room	285
<i>Apollo 9</i> earth orbital activities	287
<i>Apollo 10</i>	297
LM cutaway view	305
<i>Apollo 11</i> activities	308,309
Launch Control Center	317
<i>Apollo 12</i> EVA	320
Mobile Quarantine Facility after splashdown	321
Lunar sample collected by <i>Apollo 11</i>	326
<i>Apollo 13</i>	330,331
Space Environment Simulation Laboratory	336
Mobile equipment transporter	338
Changes in SM oxygen tank	339
Lunar landing training vehicle	340
<i>Apollo 14</i>	343
<i>Apollo 15</i> crew, equipment, experiments	344
Extravehicular mobility unit	345
<i>Apollo 15</i>	346,347,349
<i>Apollo 16</i>	353
Subsatellite and experiments in SIM bay	355
<i>Apollo 17</i>	359
Lunar science stations	361
Washington Cathedral Space Window	363

PREFACE

Project Apollo was announced to representatives of American industry during a conference in Washington, D.C., July 28–29, 1960, as a program to land men on the moon and return them safely to earth. President John F. Kennedy proposed to Congress on May 25, 1961, that this goal be attained before the end of the decade, stimulating an accelerated program. That challenge resulted in an ultimate success when *Apollo 11* landed on the lunar surface July 20, 1969; two astronauts walked on the moon; and they, along with their spacecraft, returned safely to earth and were recovered from the Pacific Ocean on July 24, 1969.

The Apollo Spacecraft: A Chronology, Volume I, was published in 1969. It covered the concepts that led to the Apollo program; design—decision—contract; and the lunar orbit rendezvous—mode and module. The last activity covered in Volume I was November 7, 1962.

Volume II of *The Apollo Spacecraft: A Chronology* was published in 1973 and covered the period November 8, 1962, through September 30, 1964. It, too, was broken down into three major subject areas: defining contractual relations, developing hardware distinctions, and developing software ground rules.

Volume III appeared in 1976. It covered activities beginning with October 1, 1964, and ending January 20, 1966. This was a one-part volume because almost the total emphasis during that period was on advanced design, fabrication, and testing.

This fourth and final volume of the chronology is also divided into three parts. The first, "Preparation for Flight, the Accident, and Investigation," covers the period January 21, 1966, through April 5, 1967. Part II, "Recovery, Spacecraft Redefinition, and the First Manned Flight," includes activities from April 6, 1967, through October 22, 1968. Part III, "Man Circles the Moon, the Eagle Lands, and Manned Lunar Exploration," covers October 23, 1968, through July 13, 1974.

Volume IV is more extensive than the three preceding volumes because of both the nature of events during the period covered and the length of that period.

As far as possible, primary sources were used to document the entries, with the main documentation coming from the archives of Johnson Space Center Historian James M. Grimwood. These primary sources included congressional documents, official correspondence, government and contractor status and progress reports, memorandums, working papers, and minutes of meetings. Additionally, a relatively few entries are based on NASA and contractor news releases and newspaper and magazine articles.

An effort was made at all times to cover only the most relevant events throughout the program, without concern for whether the item was about a contractor, NASA installation, or NASA Headquarters.

We have often used acronyms for the NASA installations most frequently mentioned in the text; for instance, NASA Hq., MSC for Manned Spacecraft Center (after February 17, 1973, JSC for Johnson Space Center), KSC for Kennedy Space Center, MSFC for Marshall Space Flight Center, and LaRC for Langley Research Center. A glossary of abbreviations and acronyms is given in Appendix 1.

For any errors discovered the authors accept the responsibility. For the good qualities that may be found we are indebted to the many NASA and contractor personnel members who contributed materials and gave us advice. These include Grimwood and Sally D. Gates from the JSC History Office; Frank W. Anderson, Jr., of the NASA History Office for his patience and prompt responses to many questions; Lee D. Saegesser, who kept a constant flow of documentation uncovered by him coming our way; and Hilda J. Grimwood, who typed this effort and fought the battle of converting seemingly never-ending statistics from the U.S. standard units of measure to the metric system and managed to keep a smile on her face while doing so.

I.D.E.
R.W.N.
C.G.B.

April 1975

PART I

Preparation for Flight, the Accident, and Investigation

January 21, 1966, through April 5, 1967

PART I

The Key Events

1966

- February 14:* First scientific experiments for lunar surface investigations were selected.
- February 26:* Apollo Saturn 201—an Apollo Block I spacecraft (CSM 009) on a Saturn IB launch vehicle—was launched from Cape Kennedy on a suborbital test mission.
- March 8:* First integrated test of service propulsion system, electrical power system, and cryogenic gas storage system was successfully completed at White Sands, N. Mex., Test Facility.
- March 16:* Gemini VIII mission was launched with astronauts Neil A. Armstrong and David R. Scott. The crew rendezvoused with the target vehicle, and the first docking in space was confirmed 6 hours 33 minutes after liftoff.
- During March:* NASA Hq. told Congress run-out cost of Apollo program would be an estimated \$22.718 billion.
- May 5:* The Apollo Spacecraft Program Office was asked to reassess spacecraft control weights and delta V budget and prepare recommendations for first lunar landing mission weight and performance budgets.
- May 19:* After a fire in the environmental control system unit at AiResearch, a concerted effort was under way to identify nonmetallic materials and other potential fire problems.
- June 2:* Surveyor 1 softlanded on the moon and began transmitting the first of 10000 clear, detailed TV pictures to earth.
- July 5:* AS-203 was launched on an unmanned orbital test mission. All objectives were achieved. No recovery was planned.
- July 26:* Robert C. Seamans, Jr., NASA Deputy Administrator, assigned specific space flight program responsibilities to the offices of each of the Associate Administrators.
- August 10:* Lunar Orbiter 1 was launched. By the time of completion of photo readouts from the spacecraft on September 14, it had photographed 9 primary potential Apollo landing sites and 11 areas on the back of the moon.
- August 25:* AS-202 was launched on an unmanned suborbital test mission. The space vehicle comprised S-IB stage, S-IVB stage, instrument unit, CSM 011. Spacecraft recovery was in Pacific Ocean.
- October 19:* NASA announced that AS-204 would be the first Apollo manned flight (earth orbital). Crewmen named were Virgil I. Grissom, Edward H. White II, and Roger B. Chaffee.
- November 6:* Lunar Orbiter II was launched. During a 23-day operational period it photographed 13 Apollo primary potential landing sites and a number of secondary sites. Two micrometeorite hits were detected.
- December 13:* Lunar landing research vehicle No. 1 was received at MSC.
- December 22:* NASA announced names of crews selected for second and third manned Apollo missions.

1967

- January 19:* Numerous deficiencies were noted in the AS-204 spacecraft (CSM 012) during testing at Downey, Calif., and KSC.
- January 20:* The S-IVB stage for Saturn launch vehicle 503 exploded and was destroyed at the Douglas Co., Sacramento, Calif., Test Facility.
- January 23:* The Lunar Mission Planning Board held its first meeting. Principal topic was photography from Lunar Orbiter missions and application to Apollo landing site selection.
- January 27:* During a simulated countdown for the AS-204 mission, a flash fire swept through command module 012, taking the lives of the crew, Virgil I. Grissom, Edward H. White II, and Roger B. Chaffee.

PART I: PREPARATION FOR FLIGHT AND THE ACCIDENT

January 28: The Apollo 204 Review Board was established by NASA Deputy Administrator Robert C. Seamans, Jr., to investigate the AS-204 accident.

February 1: Manned Spaceflight Center directed contractors and government agencies to stop all MSC-related manned testing in environments with high oxygen content until further notice.

February 7: The Apollo 204 Review Board Chairman established 21 Task Panels to support the Board in its investigation.

February 10: The Board of Inquiry into the January 20 S-IVB stage explosion identified the probable cause of the accident.

March 14: Apollo Program Director Samuel C. Phillips appointed a team to make a special audit of quality control and inspection procedures and contractors and NASA Centers.

April 5: The Apollo 204 Review Board sent its final report to NASA Administrator James E. Webb.

PART I

Preparation for Flight, the Accident, and Investigation

January 21, 1966, through April 5, 1967

NASA converted one of its major contracts from a cost-plus-fixed-fee to a cost-plus-incentive-fee agreement. The contract was with North American Aviation's Space and Information Systems Division, Downey, Calif., for development of the Apollo spacecraft command and service modules (CSM) and spacecraft-lunar excursion module adapter (SLA).

1966
January
21

NASA News Release 66-15, "Apollo Spacecraft Major Contract Is Converted," Jan. 21, 1966.

NASA negotiated a contract with Massachusetts Institute of Technology (MIT) for a program of radar and radiometric measurements on the surface of the moon. The program, which would be active until March 31, 1967, would have Paul B. Sebring of MIT's Lincoln Laboratory as principal investigator. Results would be used to select areas for intensive study to support investigations related to manned landing sites.

21

Arthur T. Strickland of NASA's Lunar and Planetary Programs Office would be the technical monitor. Andrew Patteson of the MSC Lunar Surface Technology Branch was requested as alternate technical monitor.

Ltr., Oran W. Nicks, NASA Hq., to Robert R. Gilruth, MSC, "Alternate Technical Monitor for MIT Contract NSR 22-009-106," Jan. 21, 1966.

The Manned Spacecraft Center (MSC) Checkout and Test Division was informed by the Flight Crew Operations Director that in reference to a request for "our desires for altitude chamber runs on Apollo spacecraft, we definitely feel three runs are mandatory on CSMs 012 and 014. For planning purposes I think we should assume this is a steady-state requirement although it should be a subject for review as we accumulate experience." Runs on backup crews had been deleted in several instances if they had already flown and the mission was essentially the same. The value of chamber runs in terms of crew confidence was great and it was assumed that no one would care to make a manned run without a previous unmanned run.

28

Memo, Donald K. Slayton, MSC, to Chief, Checkout and Test Div., MSC, "Altitude Chamber runs on manned spacecraft," Jan. 28, 1966.

1966

January

28

NASA Hq. requested the Apollo Spacecraft Program Office at Manned Spacecraft Center to evaluate the impact, including the effect on ground support equipment and mission control, of a dual AS-207/208 flight as early as AS-207 was currently scheduled. ASPO was to assume that launch vehicle 207 would carry the Block II CSM, launch vehicle 208 would carry the lunar excursion module (LEM), and the two launches would be nearly simultaneous. Kennedy Space Center (KSC) and Marshall Space Flight Center (MSFC) were asked to make similar studies for their systems. Response was requested by February 7, 1966.

TWX. Samuel C. Phillips, NASA OMSF, to Joseph F. Shea, MSC, Jan. 28, 1966.

February

1

MSC's Robert R. Gilruth, Maxime A Faget, and William E. Stoney visited Langley Research Center to discuss the Orbiter program status and plans for distributing photos obtained from Orbiter with Floyd Thompson, Charles Donlan, and other Langley personnel members connected with the Orbiter program. Important aspects of the program were presented, with particular emphasis on the camera system and the kind and quality of photography to be obtained. In the discussion of data handling it was apparent there were no conflicts of purpose or planned activity between LaRC and MSC. It was determined that strong MSC representation at Langley during the photo screening period would be advantageous to MSC and of great benefit in MSC's subsequent lunar landing site evaluation.

Memo for Record, Faget, "Discussion between MSC and Langley Research Center regarding reduction of Orbiter data," March 1, 1966.

1

MSC Assistant Director for Flight Crew Operations Donald K. Slayton said he did not think that current testing or proposed evaluation would do anything to resolve the basic debate between optics versus radar as a primary LEM rendezvous aid. Slayton said, "The question is not which system can be manufactured, packaged, and qualified as flight hardware at the earliest date; it is which design is most operationally suited to accomplishing the lunar mission. The 'Olympics' contribute nothing to solving this problem." He proposed that an MSC management design review of both systems at the earliest reasonable date was the only way to reach a conclusion, adding, "This requires only existing paperwork and knowledge—no hardware."

Memo, Slayton to Chief, Guidance and Control Div., MSC, "LORS-RR 'Olympics,'" Feb. 1, 1966.

2

MSC awarded \$70 000 contract to Rodana Research Corp. to develop emergency medical kits that would "satisfy all inflight and training requirements for the Apollo Command Module and the Lunar Excursion Module." Under terms of contract, two training units would be delivered for each flight, in addition to one mockup and six prototype models. The small kits would contain loaded injectors, tablets, capsules, ointments, inhalers, adhesives, and compressed dressings.

MSC News Release 66-8, Feb. 2, 1966.

1966
February
2-24

In response to a January 28 TWX from NASA Hq., MSC personnel made recommendations after evaluating the impact of a dual AS-207/208 flight on ground support and mission control. On February 2, John P. Mayer, Chief, Mission Planning and Analysis Division, told the Assistant Director for Flight Operations that the sole area of concern would be in providing the necessary Real Time Computer Complex readiness in a time frame consistent with the AS-207 launch schedule. Mayer also recommended that a decision be made in the very near future to commit AS-207 and AS-208 to a dual mission and that, if possible, IBM personnel knowledgeable in the Gemini dual vehicle system be diverted to the proposed mission if major modifications were not required for the Gemini XI and Gemini XII missions.

On February 4, John D. Hodge, Chief of the Flight Control Division, listed for the Technical Assistant for Apollo some problem areas that could arise in the operational aspects of the proposed mission with AS-207 carrying a manned CSM and AS-208 carrying only a LEM. Hodge recommended that the two launches not be attempted simultaneously, saying that some time between the launches should be determined, which would eliminate most of the problems anticipated.

Howard W. Tindall, Jr., Assistant Chief, Mission Planning and Analysis Division, in a memo documented some design criteria and philosophy on which the AS-207/208 rendezvous mission plan was being developed by the Rendezvous Analysis Branch. Tindall pointed out that, from the Gemini program experience, the plan was felt to be relatively firm. Tindall named some of the basic features recommended by the study: (1) The CSM should be launched before the LEM. (2) The first CSM orbit should be 482 km and the LEM orbit should be 203 km high, both circular. The inclination should be about 29°. (3) There should be two "on-time" launch opportunities each day of about three minutes each, during which a LEM launch would provide ideal in-plane and phasing conditions. (4) It was anticipated that the basic rendezvous could be completed within four-and-a-half hours after LEM liftoff. (5) It was estimated that about 1317 km per hr of spacecraft in-orbit propulsion would be required to carry out the rendezvous, with about seven service propulsion system maneuvers including terminal phase initiation.

MSC Memos, Mayer to Assistant Director for Flight Operations, "Dual Apollo Missions," Feb. 2, 1966; Hodge to Technical Assistant for Apollo, "Simultaneous Launch for AS-207 and AS-208," Feb. 4, 1967; Tindall to distribution, "Apollo AS-207/208 rendezvous mission planning," Feb. 24, 1966.

Alfred Cohen, head of the ground support equipment (GSE) office of the Resident Apollo Spacecraft Office (RASPO) at Grumman Aircraft Engineering Corp., objected to the unrealistic production schedule set up by Grumman Manufacturing for LEM GSE. Cohen pointed out that Grumman had been notified many times that NASA did not believe that

4

1966
February

GSE could be produced in the short time spans formulated by Grumman. Cohen added that Grumman had been informed that this disbelief was based on actual experience with North American Aviation and McDonnell Aircraft Corp. Tracking of the manufacture of such items showed that Grumman was unable to produce in accordance with schedules. Cohen cited that Grumman had planned to complete 99 GSE items in December 1965 and had completed 27; in January it had scheduled 146 items for completion and had completed 43. Cohen requested that the RASPO Manager confront Grumman management with the facts and suggest that they (1) establish realistic schedules for fabricating GSE based on past experience; and (2) step up efforts in expediting purchase of parts and adding manpower that would be required.

Memo, Cohen to Manager, RASPO, "Manufacturing of GSE, Unrealistic Planning," Feb. 4, 1966.

6-8

The first test of the cryogenic gas storage system was successfully conducted from 12:30 p.m. February 6 through 8:50 p.m. February 8 at the White Sands Test Facility (WSTF), N. Mex. Primary objectives were to demonstrate the compatibility between the ground support equipment and cryogenic subsystem with respect to mechanical, thermodynamic, and electrical interfaces during checkout, servicing, monitoring, and ground control. All objectives were attained.

TWX, MSC WSTF to MSC, "Preliminary Report, First Cryogenic System Test at WSTF," Feb. 9, 1966.

7

The CSM weight program was reviewed by James L. Bullard of MSC and D. Morgan of North American Aviation at a meeting in Houston. The CM 011 projected weight was at its upper limit as designed by the earth-landing-system restraint, about 68 kilograms above the maximum weight used for mission planning. Data to revise the 011 specification to show a CM weight of 5352 kilograms were being prepared.

CMs 012 and 014 would present definite weight problems. At the time the CM weight vs earth-landing-system factors of safety relationships were investigated in the study of the possibility of shaving ablator material from the heatshield, a maximum weight of 5296 kilograms was established for the manned spacecraft. Bullard had discussed the possibility of a higher CM weight with James M. Peacock of the Systems Engineering Division and the earth-landing-system subsystem manager but had received no definite reply. Bullard said it was imperative that a firm weight be established, above which the weight could not grow, before any weight reductions could be seriously considered. It appeared that 90 to 136 kilograms would have to be eliminated from the spacecraft, and that the reduction would have to be accomplished primarily by removing items.

Memo, Bullard to Chief, Systems Engineering Div., "CSM weight status," Feb. 7, 1966.

1966
February
14

NASA's Associate Administrator for Space Science and Applications Homer E. Newell advised MSC that he had selected space science investigations to be carried to the moon on Apollo missions, emplaced on the lunar surface by Apollo astronauts, and left behind to collect and transmit data to the earth on lunar environmental characteristics following those missions. Newell assigned the experiments to specific missions and indicated their priority. Any changes in the assignments would require Newell's approval. The experiments, institutions responsible, and principal investigators and coinvestigators were:

- Passive Lunar Seismic Experiment, Massachusetts Institute of Technology, Frank Press; Columbia University, George Sutton.
- Lunar Tri-axis Magnetometer, Ames Research Center, C. P. Sonett; MSC, Jerry Modisette.
- Medium-Energy Solar Wind, Jet Propulsion Laboratory (JPL), C. W. Snyder; JPL, M. M. Neugebauer.
- Suprathermal Ion Detection, Rice University, J. W. Freeman, Jr.; MSC, F. C. Michel.
- Lunar Heat Flow Management, Columbia University, M. Langseth; Yale University, S. Clark.
- Low-Energy Solar Wind, Rice University, B. J. O'Brien.
- Active Lunar Seismic Experiment, Stanford University, R. L. Kovach; U.S. Geological Survey, J. S. Watkins.

By separate actions, Newell asked the Associate Administrator for Manned Space Flight to approve the assignment of these experiments to the Apollo Program and the Director of the Apollo Program was asked to assign the experiments, part of the Apollo Lunar Surface Experiment Package, to the missions indicated. MSC was authorized to use not in excess of \$5.109 million to develop the experiments through flight-qualified prototype, including provision for all necessary software for operational and support purposes, as well as data analysis.

Ltr., Newell to MSC, Attn: Manager, Experiments Program Office, "Authorization to Procure Space Science and Applications Investigations for Apollo Lunar Missions," Feb. 14, 1966.

NASA announced conversion of its contract with Grumman Aircraft Engineering Corp. for development of the LEM to a cost-plus-incentive agreement. Under the terms of the new four-year contract Grumman was to deliver 15 flight articles, 10 test articles, and 2 mission simulators. The change added 4 flight articles to the program. The contract provided incentive for outstanding performance, cost control, and timely delivery as well as potential profit reductions if performance, cost, and schedule requirements were not met.

15

TWX, NASA Hq. to MSC, MSFC, Western Operations Office, KSC, Attn: Public Information Officers, NASA Converts Apollo Contract to Cost-Plus-Incentive," Feb. 15, 1966.

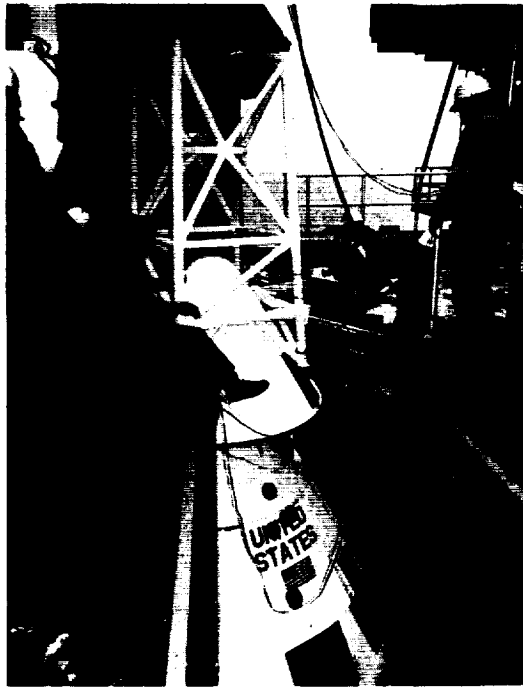

The launch escape system is mated to Apollo spacecraft 009 atop the Launch Complex 34 service tower at Cape Canaveral, in December 1965 preparations for the February 26, 1966, AS-201 mission.

1966
February

The LEM Configuration Control Panel approved Grumman's request for government-furnished-equipment (North American Aviation-manufactured) optical alignment sights (OAS) for installation in the LEM. A total of 21 OAS units would be required (including 2 spares). Detailed interface requirements between the OAS and LEM would be negotiated between North American and Grumman and delivery dates would be specified during negotiations.

Memo, Project Officer, LEM, MSC, to Project Officer, CSM, MSC, "PCCP SID-150-551 Optical Alignment Sights for Use in LEM," Feb. 25, 1966.

26

Apollo-Saturn 201 was launched from Cape Kennedy, with liftoff of an Apollo Block I spacecraft (CSM 009) on a Saturn IB launch vehicle at 11:12:01 EST. Launched from Launch Complex 34, the unmanned suborbital mission was the first flight test of the Saturn IB and an Apollo spacecraft. Total launch weight was 22 000 kilograms.

Spacecraft communications blackout lasted 1 minute 22 seconds. Reentry was initiated with a space-fixed velocity of 29 000 kilometers per hour. CM structure and heatshields performed adequately. The CM was recovered from the Atlantic about 72 kilometers uprange from the planned landing point. (Mission objectives are listed in Appendix 5.)

Missions Operations Div., MSC, "Postlaunch Report for Mission AS-201 (Apollo S/C 009)," May 6, 1966.

March
1

Recent discussion between Axel Mattson of LaRC and Donald K. Slayton of MSC concerning the possibility of astronauts' using the Lunar Landing Research Facility (LLRF) at Langley led to agreement that astronauts

1966

March

should fly the LLRF for a week before flying the MSC lunar landing training vehicle. An evaluation of the proposal at MSC resulted in a letter from Director Robert R. Gilruth to LaRC Director Floyd L. Thompson indicating the desirability of using the LLRF and also the desirability of some equipment modifications that would improve the vehicle with a minimum effort. These included such items as LEM flight instruments, hand controllers, panel modifications, and software changes. Also discussed was the training benefit that could be realized if the facility were updated to use a vehicle like the LEM so the pilots could become familiar with problems of a standup restraint system, pressure suit and helmet interface with the cockpit structure and window during landing operations, and sensing and reacting to the dynamic cues of motion while standing up.

Ltr., Gilruth to Thompson, March 1, 1966.

ASPO Manager Joseph F. Shea informed Apollo Program Director Samuel C. Phillips, in response to a January 28 TWX from Phillips, that MSC had evaluated the capability to support a dual launch of AS-207/208 provided an immediate go-ahead could be given to the contractors. Shea said the evaluation had covered mission planning, ground support equipment (GSE), flight hardware, and operations support. Modifications and additional GSE would be required to update Launch Complex 34 at Cape Kennedy to support a Block II CSM. The total cost of supporting the AS-207/208 dual launch was estimated at \$10.2 million for the GSE and additional boiler plate CSM configuration, but Shea added that these costs could be absorbed within the FY 1966 budget. Shea recommended that the dual mission be incorporated into the program.

1

TWX, Shea to Phillips, "Saturn IB Dual Launch," March 1, 1966.

The 1/6-g simulator, developed at the Manned Spacecraft Center, is shown in action as a suited subject crosses the "lunar landscape" at the Center in March 1966. The simulator was designed to give astronauts experience in the activities they would perform during missions on the moon, with gravity one-sixth earth's.

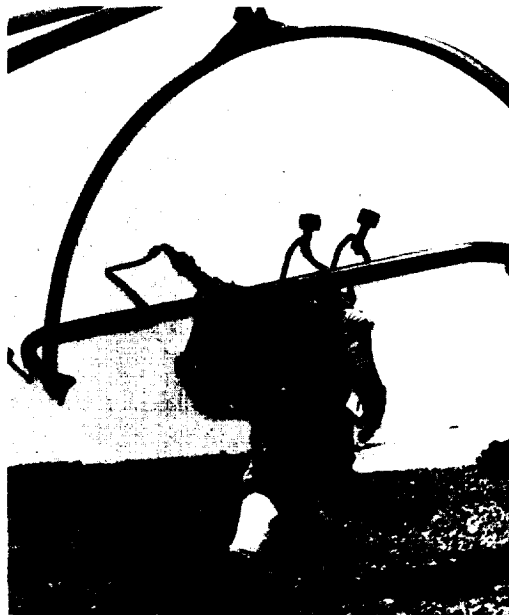

1966

March

7

Apollo Program Director Samuel C. Phillips, in a memo to the Director, Office of Advanced Research and Technology, NASA Hq., pointed out that in July 1965 the Apollo program encountered stress corrosion of titanium tanks from nitrogen tetroxide propellant, and that through his auspices Langley Research Center initiated a crash effort that had been a key factor in solving the problem. Phillips said that Langley's effort had been vigorous, thorough, and of the highest professional calibre. An excellent team relationship had been maintained with MSC, MSFC, KSC, vehicle contractors, and tank subcontractors and LaRC personnel had given dedicated and outstanding support. He cited that (1) within nine days from go-ahead a test facility was constructed, equipped, and in operation; (2) within one hour after the request from MSC, coupon tests were under way in support of the *Gemini VII* flight; (3) glass bead peening was demonstrated as a solution and many tanks were peened on a crash schedule for flight and test use; and (4) coupon tests in direct support of AS-201 were instrumental in providing confidence for proceeding with that flight.

Memo, Phillips to Director, Research Div., NASA OART, "Compatibility of Titanium Propellant Tanks with Nitrogen Tetroxide," March 7, 1966.

8

Apollo Program Director Samuel C. Phillips notified the three manned space flight Centers that they were requested to plan for a dual AS-207/208 mission, assuming that launch would occur one month later than the 207 launch now scheduled.

TWX, Phillips to MSC, MSFC, and KSC, "Saturn IB Dual Launch," March 8, 1966.

9-10

The first integrated test of the service propulsion system, electrical power system, and cryogenic gas storage system was successfully conducted at the White Sands Test Facility.

TWX, Samuel C. Phillips to Joseph F. Shea, "Block I CSM Delivery Dates," March 14, 1966. 101," March 10, 1966.

14

NASA Hq. told MSC that delivery changes should be reflected in manned space flight schedules as controlled milestone changes and referred specifically to CSM 008—April 1966; CSM 011—April 15, 1966; and CSM 007—March 31, 1966. Headquarters noted that the "NAA [North American Aviation Inc.] contract delivery date remains 28 February 1966" for each and that "every effort should be made to deliver these articles as early as possible, since completion of each is constraining a launch or other major activity."

TWX, Samuel C. Phillips to Joseph F. Shea, "Block I CSM Delivery Dates," March 14, 1966.

16-17

The Atlas-Agena target vehicle for the *Gemini VIII* mission was successfully launched from KSC Launch Complex 14 at 10 a.m. EST March 16. The *Gemini VIII* spacecraft was launched from Launch Complex 19 at 11:41 a.m., with command pilot Neil A. Armstrong and pilot David R. Scott aboard. The spacecraft and its target vehicle rendezvoused and docked, with

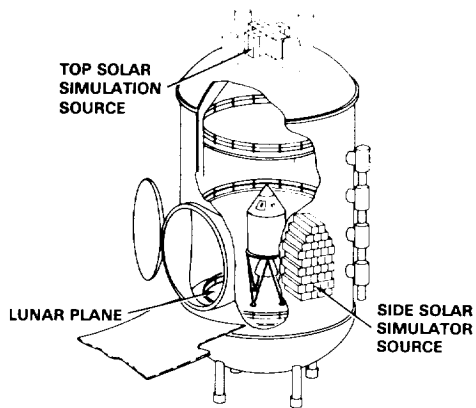

A cutaway view of the large space environment chamber in the Space Environment Simulation Laboratory at Manned Spacecraft Center shows how Apollo spacecraft components were tested at the extreme temperatures they would meet in space.

1966
March

docking confirmed 6 hours 33 minutes after the spacecraft was launched. About 27 minutes later the spacecraft-Agena combination encountered unexpected roll and yaw motion. The crew reduced the rates sufficiently to undock from the target and began troubleshooting to determine the cause of the problem. The problem arose again and when the yaw and roll rates became too high the crew activated and used both rings of the reentry control system to reduce the spacecraft rates to zero. This action required that the mission be ended, and splashdown was scheduled for the western Pacific during the seventh revolution. The spacecraft landed at 10:23 p.m. EST March 16 and Armstrong and Scott were picked up by the U.S.S. *Mason* at 1:37 a.m. EST March 17. Although the flight was cut short by the incident, one of the primary objectives—rendezvous and docking (the first rendezvous of two spacecraft in orbital flight)—was accomplished.

Memo, NASA Associate Administrator for Manned Space Flight to Administrator, "Gemini VIII Mission, Post Launch Report No. 1," March 23, 1966 (Mission Operation Report M-913-66-09).

NASA Administrator James E. Webb and Deputy Administrator Robert C. Seamans, Jr., selected Bendix Systems Division, Bendix Corp., from among three contractors for design, manufacture, test, and operational support of four deliverable packages of the Apollo Lunar Surface Experiments Package (ALSEP), with first delivery scheduled for July 1967. The estimated cost of the cost-plus-incentive-fee contract negotiated with Bendix before the presentation by the Source Evaluation Board to Webb and Seamans was \$17.3 million.

16

Memo, NASA Deputy Associate Administrator to Associate Administrator for Manned Space Flight, "Selection of Contractor for Phase D (Phase II) for Apollo Lunar Surface Experiments Package," March 17, 1966.

Apollo Program Director Samuel C. Phillips informed MSC Director Robert R. Gilruth of specific NASA Hq. management assignments that had been implemented in connection with the ALSEP program. He told Gilruth he had asked Len Reiffel to serve as the primary focus of Headquarters on

16

1966
March

ALSEP and that he would be assisted by three members of the Lunar and Planetary Program Office of the Office of Space Science and Applications: W. T. O'Bryant, E. Davin, and R. Green.

Ltr., Phillips to Gilruth, March 16, 1966.

16

MSC analysis of Grumman ground support equipment (GSE) showed that a serious problem in manufacturing and delivery of GSE would have a significant program impact if not corrected immediately. Information submitted to NASA indicated a completion rate of 35 percent of that planned. Grumman was requested to initiate action to identify causes of the problem and take immediate remedial action. A formal recovery plan was to be submitted to NASA, considering the following guidelines: (1) the plan would take into account the interrelations of the LEM vehicle, site activation, vehicle checkout, and GSE end-item manufacturing schedules; (2) a priority system should be established by which "critical" equipment would be identified, with all other equipment identified in either "preferred" or "not essential" categories ("critical" was defined as that mission-essential or mission-support equipment without which the successful completion of the vehicle test or launch would be impossible); and (3) manufacturing schedules should be revised to emphasize completion of all critical category equipment, including such means as two- or three-shift operation or additional subcontracting, or both. Grumman was required to initiate the recovery plan as soon as possible but not later than 30 days from receipt of the instructions, and progress reports were to be submitted to NASA biweekly, starting two weeks from receipt of the TWX.

TWX, James L. Neal, MSC, to Grumman, Attn: J. C. Snedecker, "LEM GSE," March 16, 1966.

17

John D. Hodge, Chief of MSC's Flight Control Division, proposed that time-critical aborts in the event of a service propulsion system failure after translunar injection (TLI; i.e., insertion on a trajectory toward the moon) be investigated. Time-critical abort was defined as an abort occurring within 12 hours after TLI and requiring reentry in less than two days after the abort.

He suggested that if an SPS failed the service module be jettisoned for a time-critical abort and both LEM propulsion systems be used for earth return, reducing the total time to return by approximately 60 hours. As an example, if the time of abort was 10 hours after translunar injection, he said, this method would require about 36 hours; if the SM were retained the return time would require about 96 hours.

He added that the LEM/CM-only configuration should be studied for any constraints that would preclude initiating this kind of time-critical abort. Some of the factors to be considered should be: (1) maximum time the LEM environmental control system could support two or three men on an earth return; (2) maximum time the CM electrical system could support minimum power-up condition; (3) time constraints on completely powering down the CM and using the LEM systems for support; (4) effects

on planned landing areas from an open loop reentry mode; (5) stability of the LEM/CM configuration during the descent and ascent propulsion burns; (6) total time to return using the descent propulsion system only or both the LEM's descent propulsion system and ascent propulsion system; and (7) communications with Manned Space Flight Network required to support this abort.

1966

March

Memo, Hodge to Technical Assistant for Apollo, MSC, "Time critical translunar coast aborts for SPS failure case," March 17, 1966.

Apollo Program Director Samuel C. Phillips discussed cost problems of the contract with General Motors' AC Electronics Division, in a memo to NASA Associate Administrator for Manned Space Flight George E. Mueller. One of the problems was late design releases from Massachusetts Institute of Technology to AC Electronics, resulting in an increase of \$2.7 million. Phillips also pointed out that computer problems at Raytheon Corp. had increased the program cost by \$6.7 million, added that many of these problems had their origins in the MIT design, and listed seven of the most significant technical problems. Phillips stated that MSC in conjunction with AC Electronics had taken several positive steps: (1) to establish a factory test method review board to review all procedures encompassing fabrication of the computer in the manufacturing process; (2) to schedule 100-percent audit of all hardware in fabrication; and (3) to increase the AC Electronics resident technical staff at the Raytheon plant.

28

Memo, Phillips to Mueller, "Cost problems on AC Electronics Contract NAS 9-497 for G&N Systems," March 28, 1966.

MSC requested use of Langley Research Center's Lunar Orbit and Landing Approach (LOLA) Simulator in connection with two technical contracts in progress with Geonautics, Inc., Washington, D.C. One was for pilotage techniques for use in the descent and ascent phases of the LEM profile, while the other specified construction of a binocular viewing device for simplified pilotage monitoring. Langley concurred with the request and suggested that MSC personnel work with Manuel J. Queijo in setting up the program, in making working arrangements between the parties concerned, and in defining the trajectories of interest.

29

Ltrs., Director, MSC, to Director, LaRC, March 29, 1966, "Use of Lunar Orbit and Landing Approach Simulator (LOLA)"; Director, LaRC, to Paul E. Purser, April 29, 1966, "Proposed pilotage study using interim LOLA simulator."

NASA Deputy Administrator Robert C. Seamans, Jr., said he had been reflecting on network coverage for Apollo, as a result of the *Gemini VIII* experience. He recognized that Apollo had more weight-carrying ability and stowage space than Gemini and that as a consequence live TV from the spacecraft might be a good possibility. This coverage could allow for extensive TV during travel to and from the moon as well as during lunar landing, disembarkation, and lunar exploration. The TV equipment would not be solely for news purposes but he felt "all manner of demands will be

30

1966

March

placed upon us for continuous live coverage." He requested a review at an early date as to (1) the technical capability of planned equipment, (2) preliminary plans for network coverage, and (3) possible modification of Apollo equipment to provide greater capability for scientific, technical, operational, and information coverage of the missions by camera and television techniques.

Memo, Seamans to George Mueller, OMSF, and Julian Scheer, NASA Hq., "Potential TV Coverage on Apollo," March 30, 1966.

31

A Space Science Office was established as an interim organizational element of MSC's Engineering and Development Directorate, pending development of a permanent organization. The Office would report to the E&D Manager, Experiments, and would be responsible for providing support technology for manned space flight in environmental elements such as space radiation, micrometeoroid flux, lunar surface conditions and planetary atmospheres. It would also participate in making measurements and conducting experiments with and from manned spacecraft. Robert O. Piland was named Acting Manager of the Office.

Memo, Maxime A. Faget, MSC, to distr., "Establishment of a Space Science Office within E&D," March 31, 1966.

**During
the
Month**

NASA OMSF prepared a position paper on NASA's estimated total cost of the manned lunar landing program. Administrator James E. Webb furnished the paper for the record of the FY 1967 Senate authorization hearings and the same statement was given to the House Committee. The paper was approved by Webb and George E. Mueller and placed the run-out costs for the program at \$22.718 billion.

MSF Staff Paper, "Statement on Cost of Manned Lunar Landing Program," March 1966.

**April
4**

MSC sent proposed organizational changes to NASA Hq. for approval by the Administrator. The two basic changes to be made were (1) establishment of a Space Medicine Directorate and (2) establishment of a Space Science Division within the Engineering and Development (E&D) Directorate. Both proposals, it was pointed out to Associate Administrator for Manned Space Flight George E. Mueller, had been discussed with him and other key members of the Headquarters staff. The proposed Space Medicine Directorate would combine the functions of the Chief of Center Medical Programs and the Center Medical Office, along with biomedical research functions currently performed in the Crew Systems Division of the E&D Directorate. The Offices of Chief of Center Medical Programs and Center Medical Office would be abolished by the change.

The Space Science Division had been discussed with NASA Associate Administrator for Space Science and Applications Homer E. Newell and would consolidate into a single organization several of the space science activities of MSC, including those under the Assistant Chief for Space Environment in Advanced Spacecraft Technology Division as well as the

planned Lunar Sample Receiving Laboratory. The four basic functions of the Division, reflecting the increased scientific program emphasis, would be (1) interpretation of environmental data for spacecraft design and operations criteria, (2) experiments, (3) obtaining lunar samples, and (4) astronaut training.

1966

April

In addition a name change was proposed for heads of the five major operating elements of MSC, from "Assistant Director for" to "Director of"; e.g., from Assistant Director for Flight Operations to Director of Flight Operations. This change was suggested to eliminate frequent and continuing misunderstandings in dealing with persons outside the organization who assumed that the "Assistant Director for Flight Operations," etc., was the number two man in that organization, rather than the number one.

Ltr., MSC Director Robert R. Gilruth to Mueller, "Changes in MSC Basic Organization," April 4, 1966.

In response to an April 1 query from George E. Mueller, NASA OMSF, asking, "Could GE or Boeing help on GAEC [Grumman Aircraft Engineering Corp.] GSE?" Apollo Program Director Samuel C. Phillips replied that on several occasions in the recent past he had made known to both Center and industry representatives that a highly capable, quick-response ground support equipment (GSE) organization had been built by and through General Electric, which the Centers and other companies should take advantage of whenever it could help with schedules or costs. He also recalled that "in one of our last two meetings with Grumman" he had reminded them of this capability and had suggested they consider it.

6

Notes, Mueller to Phillips, April 1, 1966; Phillips to Mueller, April 6, 1966.

In response to the March 30 memo from NASA Deputy Administrator Robert C. Seamans, Jr., regarding potential uses of TV on Apollo, Associate Administrator for Manned Space Flight George E. Mueller replied that ". . . we have been making a progressive review of the Apollo electronic systems. Performance and application of the Apollo TV system are being looked at as part of the review." He added that he expected to be in position by mid-May to discuss plans with Seamans in some detail.

7

Memo, Mueller to Seamans, "Potential TV Coverage on Apollo," April 7, 1966.

Deputy Administrator Robert C. Seamans, Jr., received a letter from John S. Foster, Jr., Director of Defense Research and Engineering, expressing pleasure that the agreement between the Department of Defense and NASA on extraterrestrial mapping, charting, and geodesy support had been consummated. He was returning a copy of the agreement for the NASA files.

8

Ltr., Foster to Seamans, April 8, 1966.

1966
April
12

A Bellcomm, Inc., memo to Apollo Program Director Samuel C. Phillips presented the status of the Apollo Block I spacesuit assembly. A modified Gemini suit manufactured by the David Clark Manufacturing Co., the overall assembly consisted of a constant-wear garment and a pressure garment assembly. Crew members would also be provided with coveralls to wear in a pressurized cabin as desired. The primary functional requirement of the Block I suit was to provide environmental protection in a depressurized CSM cabin. Therefore, it did not incorporate a thermal and micrometeoroid-protection garment or the helmet visor assembly, which were required for extravehicular operation. The memo listed seven major modifications required to adapt the Gemini suit to make it acceptable for use as an Apollo Block I item.

Memo, Bellcomm, Inc., to distr., "Status of Block I Space Suit Assembly (SSA) Development—Case 330," sgd. T. A. Bottomley, Jr., April 12, 1966, with Bellcomm routing slip to Phillips from J. Z. Menard, April 13, 1966.

15

MSC Director Robert R. Gilruth told Associate Administrator for Manned Space Flight George E. Mueller he felt it was necessary either to proceed with the Apollo Experiment Pallet program or to cancel the program, reaching a decision not later than April 22. Gilruth pointed out that four contracts had been initiated in December 1965 for Phase C of the program, that the contracts were completed on April 6, that full-scale mockups had been delivered, and that documentation with cost proposals were due April 22. The four contractors were McDonnell Aircraft, Martin-Denver, Northrop, and Lockheed Aircraft-Sunnyvale. Gilruth said it was apparent that all contractors had done an exceptionally good job during the Phase C effort. Low cost had been emphasized in every phase of the program, with contractors responding with a very economical device and at the same time a straightforward design that offered every chance of early availability and successful operation.

Of equal significance, he said, "the Pallet offers the opportunity to minimize the interface with both North American and the Apollo program. It provides a single interface to Apollo and NAA, allowing the multiple-experiment interfaces to be handled by a contractor whose specific interest is in experiments. If experiments are to be carried in the Service Module, the Pallet both by concept and experience offers the most economical approach." Gilruth said the following plan had been developed: (1) April 22—receive documentation and cost proposals. (2) April 22–May 22—evaluate four proposals and negotiate four acceptable contracts in the same manner as for ALSEP. (3) May 23–24—Source Evaluation Board Review. (4) May 25–June 1—Center and Headquarters Review. (5) June 1—date of cost incurrence for selected contractor. Gilruth strongly recommended that the pallet program be implemented as planned. On April 22, Mueller gave his approval to proceed as planned. (See August 22.)

Ltrs., Gilruth to Mueller, April 15, 1966; Mueller to Gilruth, April 22, 1966.

Spacecraft 007 and 011 were delivered to NASA by North American Aviation. Spacecraft 007 was delivered to Houston to be used for water impact and flotation tests in the Gulf of Mexico and in an environmental tank at Ellington AFB. It contained all recovery systems required during actual flight and the total configuration was that of a flight CM.

1966

April

18

The CM of spacecraft 011 was similar to those in which astronauts would ride in later flights and the SM contained support systems including environmental control and fuel cell systems and the main service propulsion system. Spacecraft 011 was scheduled to be launched during the third quarter of 1966.

TWX, NAA Space and Information Systems Div. to MSC, April 18, 1966.

ASPO Manager Joseph F. Shea and members of his organization were invited to attend the formal presentation by the Aeronutronic Division of Philco Corp. on a "Study of Lunar Worm Planetary Roving Vehicle Concept," at LaRC on May 3. The exploratory study to determine the feasibility of a bellows-concept mobile vehicle included a mobility and traction analysis for several kinds of bellows motion and several soil surfaces; analysis of both metallic and nonmetallic construction to provide the bellows structure; brief design studies of the concept as applied to a small unmanned vehicle, a supply vehicle, a small lunar shelter, a large lunar shelter; and an overall evaluation of the suitability of the concept for carrying out various missions as compared with other vehicles.

18

Ltr., Floyd L. Thompson, LaRC, to Shea, "Final Briefing, Contract NAS-1-5709, 'Study of Lunar Worm Planetary Roving Vehicle Concept,' by the Aeronutronic Division of the Philco Corp.," April 18, 1966.

MSC announced the establishment of a Flight Experiment Board. The Board would select and recommend to the Director space flight experiments proposed from within the Center and judged by the Board to be in the best interest of the Center and the NASA space flight program. MSC-originated flight experiments were expected normally to be designated as one of two general classifications: Type I—Medical, Space Science, Flight Operations or Engineering that would yield new knowledge or improve the state of the art; Type II—Operational, which would be required in direct support of major manned flight programs such as Apollo.

21

Members appointed to the Board were George M. Low, chairman; Warren Gillespie, Jr., executive secretary; Maxime A. Faget; Robert O. Piland; Charles A. Berry; Christopher C. Kraft, Jr.; Donald K. Slayton; Kenneth S. Kleinknecht; and Joseph N. Kotanchik. The Board would meet bimonthly on the first Friday of every even month, with called meetings at the direction of the chairman when necessary to expedite experiments.

MSC Announcement 66-47, MSC Flight Experiments Selection Board, April 21, 1966.

1966

April

22

NASA Office of Manned Space Flight policy for Design Certification Reviews (DCRs) was defined for application to manned Apollo missions by a NASA directive. The concept stressed was that design evaluation by NASA management should begin with design reviews and inspections of subsystems and culminate in a DCR before selected flights. Documentation presented at DCRs were to reflect this sequence of progressive assessment of subsystems.

Ltr., Samuel C. Phillips to R. A. Petrone, KSC; J. F. Shea, MSC; and E. F. O'Connor, MSFC: "Program Directive No. 7—Apollo Design Certification Review," April 22, 1966.

28

J. K. Holcomb, Director of Apollo Flight Operations, NASA OMSF, reported to Apollo Program Director Samuel C. Phillips that the NASA flight scoring system was considered satisfactory in its present form. NASA Associate Administrator for Manned Space Flight George E. Mueller had taken exception to including a statement of primary and secondary objectives in the AS-202 Mission Rules Guidelines. The scoring system, established by the Office of Program Reports, labeled each flight a success or a failure in a report to the Administrator and Deputy Administrator and was used in briefing Congress and the press. Flights were categorized only as "successful" or "unsuccessful." Criteria for judging success of a mission were based on the statement of primary objectives in the Mission Operations Report. If one primary objective was missed the flight was classified as "unsuccessful."

Memo, Holcomb to Phillips, "NASA Scoring System," April 28, 1966.

May

3

MSC Director Robert R. Gilruth wrote George E. Mueller, NASA OMSF, that plans were being completed for MSC in-house, full-scale parachute tests at White Sands Missile Range (WSMR), N. Mex. The tests would be part of the effort to develop a gliding parachute system suitable for land landing with manned spacecraft. Tests were expected to begin in July 1966, with about six tests a year for two or three years. Gilruth pointed out that although full-scale tests were planned for WSMR it would not be possible to find suitable terrain at that site, at Edwards Air Force Base, Calif., or at El Centro, Calif., to determine operational and system requirements for land landing in unplanned areas. Unplanned-area landing tests were cited as not a major part of the program but a necessary part. He pointed out that the U.S. Army Reservation at Fort Hood, Tex., was the only area which had the required variety of landing obstacle sizes and concentrations suitable for the unplanned-area tests. Scale-model tests had been made and would be continued at Fort Hood without interference to training, and MSC had completed a local agreement that would permit occasional use of the reservation but required no fiscal reimbursement or administrative responsibility by MSC. This action was in response to a letter from Mueller July 8, 1965, directing that MSC give careful consideration to transfer of parachute test activities to WSMR.

Ltr., Gilruth to Mueller, "Parachute landing test areas for MSC land landing development tests," May 3, 1966.

NASA Hq. requested the MSC Apollo Spacecraft Program Office to reassess the spacecraft control weights and ΔV budget and prepare recommendations for the first lunar landing mission weight and performance budgets. The ASPO spacecraft Weight Report for April indicated that the Block II CSM, when loaded for an 8.3-day mission, would exceed its control weights by more than 180 kilograms and the projected value would exceed the control weight by more than 630 kilograms. At the same time the LEM was reported at 495 kilograms under its control weight. Credit for LEM weight reduction had been attributed to Grumman's Super Weight Improvement Program.

1966

May

5

Memo, Apollo Program Director to Manager, ASPO, "Lunar Landing Mission Weights and Performance," May 5, 1966.

Engine testing at the Arnold Engineering Development Center (AEDC) had been the subject of discussions during recent months with representatives from MSC, Apollo Program Quality and Test groups, AEDC, Air Force Systems Command and ARO, Inc., participating. While AEDC had not been able to implement formal NASA requirements, the situation had improved and MSC was receiving acceptable data.

5

In a letter to ASPO Manager Joseph F. Shea, Apollo Program Director Samuel C. Phillips said, ". . . I do not think further pressure is in order. However, in a separate letter to Lee Gossick, I have asked that he give his personal attention to the strict adherence to test procedures, up-to-date certification of instrumentation, and care and cleanliness in handling of test hardware."

Ltr., Phillips to Shea, May 5, 1966.

The Grumman-directed Apollo Mission Planning Task Force reported on studies of abort sequences for translunar coast situations and the LEM capability to support an abort if the SM had to be jettisoned. The LEM could be powered down in drifting flight except for five one-hour periods, and a three-man crew could be supported for 57 hours 30 minutes. It was assumed that all crewmen would be unsuited in the LEM or tunnel area and that the LEM cabin air, circulated by cabin fans, would provide adequate environment.

9

Grumman LEM Engineering Memo to distribution, "LEM Consumable Capability for Abort to Earth from Translunar Coast," May 9, 1966.

MSC Deputy Director George M. Low recommended to Maxime A. Faget, MSC, that, in light of Air Force and Aerospace Corp. studies on space rescue, MSC plans for a general study on space rescue be discontinued and a formal request be made to OMSF to cancel the request for proposals, which had not yet been released. As an alternative, Low suggested that MSC should cooperate with the Air Force to maximize gains from the USAF task on space rescue requirements.

11

Memo, Low to Faget, "Space rescue," May 11, 1966.

1966
May
12 A memo to KSC, MSC, and MSFC from the NASA Office of Manned Space Flight reported that the NASA Project Designation Committee had concurred in changes in Saturn/Apollo nomenclature recommended by Robert C. Seamans, Jr., George E. Mueller, and Julian Scheer:

- lunar excursion module to be called lunar module.
- Saturn IB to become the "uprated Saturn I."

The memo instructed that the new nomenclature be used in all future news releases and announcements.

Memo, NASA Hq. to Center Public Affairs Officers, May 12, 1966.

19 George E. Mueller, NASA Associate Administrator for Manned Space Flight, forwarded views and recommendations of the Interagency Committee on Back Contamination to MSC Director Robert R. Gilruth for information and necessary action. The Committee had met at MSC to discuss the status of the Lunar Receiving Laboratory (LRL) on April 13.

The committee agreed in general philosophy and preliminary specific detail with the overall design plan, schedule, size containment provisions, and functional areas of the LRL; it approved the plan to secure Baylor Medical School or an equally qualified institution to head a development for the bio-analysis protocol; it expressed its concern with the possibility of uncontrolled outventing of CM atmosphere following splashdown; and it recommended that MSC investigate alternate means of treatment and isolation of Apollo space crews and associated physicians and technicians. MSC replied on June 8 that the analytical work in the engineering and biologic areas of the recommendations had been started and that the date for review and evaluation of the studies would be June 27.

Ltrs., Mueller to Gilruth, May 19, 1966; Gilruth to Mueller, June 8, 1966; "Interagency Committee on Back Contamination Views and Recommendations," updated.

19 E. E. Christensen, NASA OMSF Director of Mission Operations, in a letter to Christopher C. Kraft, Jr., MSC, said he was certain the problem of potential mission abort was receiving considerable attention within the Flight Operations Directorate. The resulting early development of related mission rules should provide other mission activities with adequate planning information for design, engineering, procedural, and training decisions. Christensen requested that development of medical mission rules be given emphasis in planning, to minimize the necessity for late modification of spacecraft telemetry systems, on-board instrumentation, ground-based data-processing schemes, and training schedules.

Ltr., Christensen to Kraft, May 19, 1966.

19 As a result of a fire in the environmental control system (ECS) unit at AiResearch Co., a concerted effort was under way to identify nonmetallic materials as well as other potential fire problems. MSC told North American

1966

May

Aviation it appeared that at least some modifications would be required in Block I spacecraft and that modifications could be considered only as temporary expedients to correct conditions that could be more readily resolved in the original design. MSC requested that North American eliminate or restrict as far as possible combustible materials in the following categories in the Block II spacecraft: (1) materials contained in sufficient quantities to contribute materially to a fire once started, (2) materials present in lengths which could propagate a flame front over 46 centimeters, (3) materials used with the electrical system, and (4) materials that could be ignited by a spark source. Additionally, North American Aviation was requested to review, evaluate, and institute design measures to eliminate other potential fire hazards, such as hydrogen leakage from batteries, overheated lamps, and large areas of exposed fabric or foam.

TWX, C. L. Taylor, MSC, to North American Aviation, Attn: J. C. Cozad, May 19, 1966.

AS-500-F, the first full-scale Apollo Saturn V launch vehicle and spacecraft combination, was rolled out from Kennedy Space Center's Vehicle Assembly Building to the launch pad, for use in verifying launch facilities, training crews, and developing test procedures. The 111-meter, 227 000-kilogram vehicle was moved by a diesel-powered steel-link-tread crawler-transporter exactly five years after President John F. Kennedy asked the United States to commit itself to a manned lunar landing within the decade.

25

Marshall Space Flight Center News Release 66-114; MSFC, *Marshall Star*, June 1, 1966.

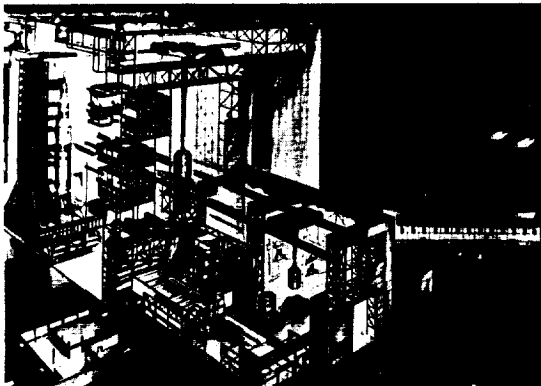

The high and low bay areas of the Vehicle Assembly Building at Kennedy Space Center provided vast space for assembling the Saturn launch vehicles and Apollo spacecraft. At right, the first full-scale Apollo-Saturn V, AS-500-F, rolls out from the VAB on the crawler-transporter May 25, 1966, five years after President Kennedy set a goal of a manned landing on the moon within the decade.

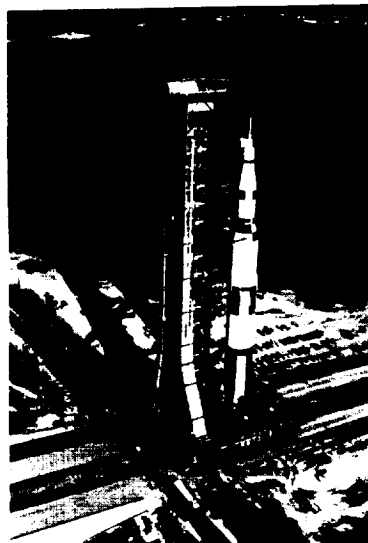

1966
May
27 ASPO Manager Joseph F. Shea informed Rocco A. Petrone, KSC, that structural problems in the CSM fuel and oxidizer tanks required standpipe modifications and that they were mandatory for Block I and Block II spacecraft. Retrofit was to be effective on CSM 011 at KSC and other vehicles at North American's plant in Downey, Calif.

TWX, Shea to Petrone, May 27, 1966.

June
1 Apollo Program Director Samuel C. Phillips asked NASA Procurement Director George J. Vecchiatti to help ensure there would be no gap in the Philco Corp. Aeronutronic Division's development of penetrometers to assess the lunar surface. Originally the penetrometers were to be deployed from a lunar survey probe, but the Apollo Program Office had concluded that they should be further developed on an urgent basis for possible deployment from the LEM just before the first lunar landing. Phillips sought to prevent development gaps that could critically delay the landing program.

Memo, Phillips to Vecchiatti, "Lunar Penetrometer Development," June 1, 1966.

2 *Surveyor I*, launched May 30 from Cape Kennedy on an Atlas-Centaur, softlanded on the moon in the Ocean of Storms and began transmitting the first of more than 10 000 clear, detailed television pictures to Jet Propulsion Laboratory's Deep Space Facility, Goldstone, Calif. The landing sequence began 3200 kilometers above the moon with the spacecraft traveling at a speed of 9700 kilometers per hour. The spacecraft was successfully slowed to 5.6 kilometers per hour by the time it reached 4-meter altitude and then free-fell to the surface at 13 kilometers per hour. The landing was so precise that the three footpads touched the surface within 19 milliseconds of each other, and it confirmed that the lunar surface could support the LM. It was the first U.S. attempt to softland on the moon.

Astronautics and Aeronautics, 1966 (NASA SP-4007, 1967), pp. 203-204.

2 MSC top management had agreed with Headquarters on early Center participation in discussions of scientific experiments for manned flights, Deputy Director George M. Low informed MSC Experiments Program Manager Robert O. Piland. NASA Associate Administrator for Space Science and Applications Homer E. Newell had asked, during a recent OSSA Senior Council meeting at MSC, that the Center and astronauts comment on technical and operational feasibility of experiments before OSSA divisions and subcommittees acted on proposals. Low and Director Robert R. Gilruth had agreed. Because of manpower requirements MSC refused a request to be represented on all the subcommittees, but MSC would send representatives to all meetings devoted primarily to manned flight experiments and would contribute to other meetings by phone.

Memo, Low to Piland, "Feasibility review of manned space science experiments," June 2, 1966.

PART I: PREPARATION FOR FLIGHT AND THE ACCIDENT

Headquarters informed MSC that MSFC had been assigned development responsibility for the S027 X-ray Astronomy experiment for integration with the Saturn S-IVB/instrument unit. Should development be found not feasible, a modified version of the equipment was planned. MSC was requested to study (1) the practicality of modifying the equipment to perform the scientific objectives and (2) the feasibility of integrating the modified experiment hardware in a Block II SM on an early Apollo Applications flight. Study results were requested no later than July 1, 1966, including cost, schedule, and technical data.

1966

June

2

Ltr., John H. Disher, NASA Hq., to George M. Low, MSC, June 2, 1966.

In response to a query on needs for or objections to an Apollo spacecraft TV system, MSC Assistant Director for Flight Crew Operations Donald K. Slayton informed the Flight Control Division that FCOD had no operational requirements for a TV capability in either the Block I or the Block II CSM or LM. He added that his Directorate would object to interference caused by checkout, crew training, and inflight time requirements.

6

Memo, Slayton to Chief, Flight Control Div., MSC, "Apollo Spacecraft Television System," June 6, 1966.

A series of actions on the LM rendezvous sensor was summarized in a memo to the MSC Apollo Procurement Branch. A competition between LM rendezvous radar and the optical tracker had been initiated in January 1966 after discussion by ASPO Manager Joseph F. Shea, NASA Associate Administrator for Manned Space Flight George E. Mueller, and MSC Guidance and Control Division Chief Robert C. Duncan. On May 13, RCA and Hughes Aircraft Co. made presentations on the rendezvous radar optical tracker. The NASA board that heard the presentations met for two days to evaluate the two programs and presented the following conclusions: (1) both sensors could meet the difficult environmental requirements of the lunar mission with near specification performance, (2) the tracker had several possible specification deviations, (3) optical production training represented a difficult schedule problem at Hughes, and (4) either sensor could be produced in time to meet LM and program schedules.

7

The board's evaluation, an analytical presentation by Donald Cheatham, a weight-and-power comparison by R. W. Williams, and a cost presentation by the two contractors were given MSC management May 19. Management recommended that RCA's radar be continued as the main effort and that a backup optical tracker program be continued by Hughes on a greatly reduced level. The recommendations were made to Apollo Program Director Samuel C. Phillips and NASA Associate Administrator George E. Mueller at KSC on May 25. Phillips and Mueller concurred but stipulated that the optical tracker program was to be completed on a fixed-price basis and that MSC would qualify the optical tracker using the facilities of the MSC laboratories. Mueller expressed concern about developmental

- 1966**
June difficulties and possible production problems in the radar program. RCA representatives visited MSC May 27 and reviewed all developmental difficulties and their potential effect on production.
- Memo, Robert C. Duncan, MSC, to Henry P. Yscheck, MSC, "LEM Rendezvous Sensor Evaluation," June 7, 1966.
- 9** MSC informed the NASA Associate Administrator for Manned Space Flight that it had established a Lunar Receiving Laboratory Program Office with Joseph V. Piland as Program Manager. The office included the functions of program control, procurement, requirements, engineering, and construction.
- Ltr., MSC Director Robert R. Gilruth to George E. Mueller, NASA OMSF, June 9, 1966.
- 16** The MSC Flight Experiments Selection Board reviewed and endorsed three proposals for analysis of lunar samples and forwarded them to NASA Hq. for consideration. Titles of the proposals and principal investigators were:
1. Cataloging and Preliminary Examination of Lunar Samples—E. A. King, MSC
 2. Study of Alpha Particle Activity of Returned Lunar Samples—K. A. Richardson, MSC
 3. Analysis of Lunar Sample Effluent Gases for Organic Components—G. G. Meisells, University of Houston, and D. A. Flory, MSC.
- Ltrs., MSC Director to NASA Hq., Attn: Homer E. Newell, "Proposals for analysis of lunar samples," June 16, 1966.
- 16** Joseph N. Kotanchik, MSC, told H. E. McCoy of KSC that his April 4 letter discussing problems and solutions in packing parachutes at KSC by Northrop-Ventura Co. had been studied. To effect economies in the program and move forward delivery of a complete spacecraft to KSC, the upper-deck buildup would be done at North American Aviation's plant in Downey, Calif., and therefore parachutes would be packed at Northrop-Ventura beginning with spacecraft 017. Kotanchik requested KSC to support the parachute packing at Northrop-Ventura by assigning two experienced inspectors for the period required (estimated at two to four weeks for each spacecraft).
- Ltr., Kotanchik to McCoy, "Apollo Spacecraft parachute packing," June 16, 1966.
- 23** A memorandum for the file, prepared by J. S. Dudek of Bellcomm, Inc., proposed a two-burn deboost technique that required establishing an initial lunar parking orbit and, after a coast phase, performing an added plane change to attain the final lunar parking orbit. The two-burn deboost technique would make a much larger lunar area accessible than that provided by the existing Apollo mission profile, which used a single burn to place the CSM and LM directly in a circular lunar parking orbit over the landing site and would permit accessibility to only a bow-tie shaped area

PART I: PREPARATION FOR FLIGHT AND THE ACCIDENT

approximately centered about the lunar equator. On August 1, the memo was forwarded to Apollo Program Director Samuel C. Phillips, stating that the trajectory modification would increase the accessible lunar area about threefold. The note to Phillips from R. L. Wagner stated that discussions had been held with MSC and it appeared that the flight programs as planned at the time could handle the modified mission.

1966

June

Memo for file, Bellcomm, Inc., "A Generalized Two Burn Deboost Technique which Increases Apollo Lunar Accessibility—Case 310," June 23, 1966; note, Wagner to Phillips, "Working Note," Aug. 1, 1966.

Grumman LM thermodynamics studies showed the LM thermal shield would have to be modified because fire-in-the-hole pressures and temperatures had increased. Portions of the LM descent stage would be redesigned, but modification of the descent stage blast deflector was unlikely.

30

Apollo Spacecraft Program Quarterly Report No. 16, for Period Ending June 30, 1966.

Crew procedures in the LM during lunar stay were reported completed and documented for presentation to NASA Hq. personnel.

30

Apollo Spacecraft Program Quarterly Status Report No. 16, for Period Ending June 30, 1966.

Melvyn Savage, Apollo Test Director in NASA Hq., was named to head the Apollo Applications Program Test Directorate. LeRoy E. Day was named to replace Savage in Apollo.

July

1

Note, John H. Disher, NASA OMSF, to Monte Wright, NASA History Office, "Comments on Volume IV—The Apollo Spacecraft, Draft Copy," May 21, 1975.

The Quarterly Program Review was held at Grumman by NASA Associate Administrator for Manned Space Flight George E. Mueller and Apollo Program Director Samuel C. Phillips. Attendees included MSC's Robert R. Gilruth, Joseph F. Shea, and William A. Lee. The meeting focused on excessive costs experienced by Grumman and Grumman President L. J. Evans's announcement of the immediate establishment of a Program Control Office with a subcontract manager reporting directly to Vice President Joseph Gavin. Hugh McCullough was appointed to head the Program Control Office.

**Week
Ending
July 1**

The next week Evans made the following appointments: Robert Mullaney was relieved as Program Manager and appointed Assistant to Senior Vice President George F. Titterton; William Rathke was relieved as Engineering Manager and named Program Manager; Thomas Kelly was promoted from Assistant Engineering Manager to Engineering Manager; and Brian Evans was relieved as corporate Director of Quality Assurance and appointed LEM Subcontract Manager, reporting to Gavin.

Memos, Frank X. Battersby to Chief, Apollo Procurement Br., Procurement and Contracts Div., MSC, "Weekly Activity Report, BMR Bethpage, Week Ending July 1, 1966," July 6, 1966; and "Weekly Activity Report, BMR Bethpage, Week Ending July 8, 1966," July 12, 1966.

1966

July

1

Director of Flight Operations Christopher C. Kraft, Jr., said that MSC had been directed by NASA OMSF to outline technical problems and both cost and schedule impact of adding three backup Apollo missions to the planned flight schedule. The missions to be evaluated would be AS-207/208 or AS-206/207; AS-503D; and AS-503F. Each of these missions would provide alternate means of obtaining primary program objectives in the event of flight contingencies during tests or of major schedule adjustments. They had been constructed using as much of the primary mission characteristics as possible. The goal was to be able to switch from a primary to a backup mission within three or four months before a launch without any schedule slip. Kraft pointed out that it was unlikely that additional funds would be available to cover the additional work and that it was important to determine areas in the primary mission plan that would suffer from either dilution or deletion should a decision be made to make these missions a part of the test development program. Recognizing that a number of man-weeks of effort would be required for adequate evaluation, Kraft requested that any impact determined from inclusion of the flights in the test program be made available at MSC for coordination and presentation to Apollo Program Director by July 15.

Memo, Kraft to distr., "Evaluation of the technical problems, cost and schedule impact of adding Apollo backup missions to the flight test programs," July 1, 1966.

5

AS-203 lifted off from Launch Complex 37, Eastern Test Range, at 10:53 a.m. EDT in the second of three Apollo-Saturn missions scheduled before manned flight in the Apollo program. All objectives—to acquire flight data on the S-IVB stage and instrument unit—were achieved.

The uprated Saturn I—consisting of an S-IB stage, S-IVB stage, and an instrument unit—boosted an unmanned payload into an original orbit of 185 by 189 kilometers. The inboard engine cutoff of the first stage occurred after 2 minutes 18 seconds of flight and the outboard engine cutoff was 4 seconds later. The S-IVB engine burned 4 minutes 50 seconds. No recovery was planned and the payload was expected to enter the earth's atmosphere after about four days.

Astronautics and Aeronautics, 1966, (NASA SP-4007, 1967), p. 233; memos, Mission Director for Apollo-Saturn 203, "AS-203 Mission Director's Post Mission Report," undated; Associate Administrator for Manned Space Flight to Administrator, "Apollo-Saturn Flight Mission AS-203, Post Launch Report No. 1" (Mission Operation Report M-932-66-02), July 15, 1966.

5

NASA requested assignment of three additional sanitary engineers from the Public Health Service. Pointing out that one sanitary engineer had been on detail to NASA since 1964 and that his effort had been directed primarily to the control of outbound contamination, NASA said this problem and that of back contamination had reached proportions that required a more intensified effort. NASA would reimburse the Public Health Service under contract.

Ltr., Deputy Administrator Robert C. Seamans, Jr., to William Stewart, Public Health Service, July 5, 1966.

North American Aviation informed Grumman that it was closing out its office at Grumman's Bethpage, N.Y., plant at the close of business on July 8. If study found that reestablishment of a Space and Information Division resident representative at Bethpage was in the best interest of the program, North American Aviation would comply.

1966

July

6

TWX, North American Aviation, Space and Information Systems Div., Downey, Calif., to Grumman, Bethpage, N.Y., July 6, 1966.

Homer E. Newell, NASA Associate Administrator for Space Science and Applications, told George E. Mueller, NASA Associate Administrator for Manned Space Flight, that "the highest scientific priority for the Apollo mission is for return to earth of lunar surface material." He added that the material would have a higher scientific value for geologists if the location and attitude of each sample were carefully noted and for the biologists if collected in an aseptic manner. He suggested the following sequence:

6

1. Collect an assortment of easily obtainable samples of any surface material at the landing site. The grab samples would be placed in the LM for easy packaging preparatory to return to earth for analysis if the planned stay time on the lunar surface was cut short.

2. Deploy the ALSEP.

3. Perform the lunar geological equipment experiment, which was a detailed geological and biological traverse by an astronaut. During this traverse both representative and unusual rocks or formations should be photographed and sampled.

Ltr., Newell to Mueller, "Apollo Lunar Surface Scientific Operational Procedure," July 6, 1966.

In reply to a letter from Grumman, MSC concurred with the recommendation that a 135-centimeter lunar surface probe be provided on each landing-leg footpad and that the engine cutoff logic retain its basic manual mode. MSC did not concur with the Grumman recommendation to incorporate the automatic engine cutoff logic in the LM design. MSC believed that the planned descent-stage engine's manual cutoff landing mode was adequate to accomplish lunar touchdown and had decided that the probe-actuated cutoff capability should not be included in the LM design.

11

TWX, James L. Neal, MSC, to Grumman, Attn: R. S. Mullaney, "LM Lunar Touchdown Logic," July 11, 1966.

MSC Director of Flight Crew Operations Donald K. Slayton and Director of Flight Operations Christopher C. Kraft, Jr., told ASPO Manager Joseph F. Shea: "A comprehensive examination of the Apollo missions leading to the lunar landing indicates that there is a considerable discontinuity between missions AS-205 and AS-207/208. Both missions AS-204 and AS-205 are essentially long duration system validation flights. AS-207/208 is the first of a series of very complicated missions. A valid operational requirement exists to include an optical equal-period rendezvous on AS-205. The rendezvous

13

1966
July would be similar to the one initially planned for the *Gemini VII* flight using, in this case, the S-IVB as the target vehicle." The maneuver would give the crew an opportunity to examine the control dynamics, visibility, and piloting techniques required to perform the basic AS-207/208 mission.

Memo. Slayton and Kraft to Shea, "Equal-Period Rendezvous for AS-205," July 13, 1966.

20 MSC Director Robert R. Gilruth informed MSFC Director Wernher von Braun that for the past two years MSC had studied the use of the mapping and survey system (M&SS) in conjunction with the Apollo program. The system objective would be lunar mapping and landing site certification, and management responsibility was assigned to the MSC Experiments Program Office. System parameters had been established and a decision made to configure the M&SS hardware and supporting systems in a cylindrical container. The container—a "payload module"—would be carried in the spacecraft-LM adapter in place of the LM during the boost phase of flight. The payload module would have docking capability with the CSM like the LM's and, in the docked mode, would map and survey the moon in a programmed lunar orbit.

The M&SS experiment had already been funded by NASA OMSF and would support five possible flights beginning with AS-504. Gilruth forwarded a statement of work and requested MSFC to study it and furnish MSC a cost estimate, technical proposal, and management plan by July 29.

Ltr., Gilruth to von Braun, July 20, 1966.

26 NASA Deputy Administrator Robert C. Seamans, Jr., told the Associate Administrators that it was NASA's fundamental policy that projects and programs were best planned and executed when responsibilities were clearly assigned to a management group. He then assigned full responsibility for Apollo and Apollo Applications missions to the Office of Manned Space Flight. OMSF would fund approved integral experiment hardware, provide the required Apollo and Saturn systems, integrate the experiments with those systems, and plan and execute the missions. Specific responsibility for developing and testing individual experiments would be assigned on the basis of experiment complexity, integration requirements, and relation to the prime mission objectives, by the Office of Administrator after receiving recommendations from Associate Administrators.

The Office of Space Science and Applications (OSSA) would be responsible for selecting scientific experiments for manned missions and the experimenter teams for data reduction, data analysis, and dissemination. OSSA would provide to OMSF complete scientific requirements for each experiment selected for flight.

The Office of Advanced Research and Technology (OART) was assigned the overall responsibility for the technology content of the NASA space flight program and for selecting technology experiments for manned missions. OART would provide OMSF complete technology requirements for each

experiment selected for flight. When appropriate, scientific and technical personnel would be located in OMSF to provide a working interface with experimenters. The office responsible for each experiment would determine the tracking and acquisition requirements for each experiment; then OMSF would integrate the requirements for all experiments and forward the total requirements to the Office of Tracking and Data Acquisition.

1966

July

Seamans also spelled out Center responsibilities for manned space flight missions: MSFC, Apollo telescope mount; MSC, Apollo lunar surface experiment package (ALSEP), lunar science experiments, earth resources experiments, and life support systems; and Goddard Space Flight Center, atmospheric science, meteorology, and astronomical science experiments.

Memo, Seamans to distr., "Management Responsibilities for Future Manned Flight Activities," July 26, 1966.

NASA Hq. authorized MSC to proceed with opening bids on August 1 for Phase I construction of the Lunar Receiving Laboratory. MSC was requested to announce the name of the contractor selected for final negotiations for Phase II construction, before opening bids for Phase I construction.

28

TWX, NASA Hq. to MSC, "Lunar Receiving Laboratory," July 28, 1966.

In response to a request from Apollo Program Director Samuel C. Phillips, Bellcomm, Inc., prepared a memorandum on the major concerns resulting from its review of the AC Electronics report on the Apollo Computer Design Review. In a transmittal note to Phillips, I. M. Ross said, "We have discussed these items with MSC. It is possible, however, that [Robert] Duncan and [Joseph] Shea have not been made aware of these problems." The Bellcomm memorandum for file, prepared by J. J. Rocchio, reported that in late February 1966 MSC had authorized AC Electronics Division (ACED) to initiate a complete design review of the Apollo guidance computer to ensure adequate performance during the lunar landing mission. A June 8 ACED report presented findings and included Massachusetts Institute of Technology comments on the findings. In addition to recommending a number of specific design changes, the report identified a number of areas which warranted further review. MSC authorized ACED to perform necessary additional reviews to eliminate all indeterminate design analyses and to resolve any discrepancies between the ACED and MIT positions. At the time Bellcomm prepared the memo many of the problem areas had been or were in process of being satisfactorily resolved. However, several still remained: (1) MSC had not had the opportunity to review an approved version of the final test method for the Block II/LM computer and as a result there was no official acceptance test for computers at that point, although the first of the flight-worthy computers had left the factory and the second was in final test at the factory. (2) The Design Review Report classified the timing margin of the Block II computer as indeterminate, since the team was unable to make a detailed

29

1966
July timing analysis in the allotted time. (3) Both Block I and Block II Apollo guidance computer programs had experienced serious problems with parts qualification and with obtaining semiconductor devices which could pass the flight processing specifications. (4) The lack of adequate documentation to support the Block II computer and its design was cited "as perhaps the most significant fault uncovered" by the design review team.

Bellcomm, Inc., Memo for File, "Apollo Block II/LM Guidance Computer—Case 330," sgd. J. J. Rocchio, July 29, 1966, note, Ross to Phillips, July 29, 1966.

August
1 NASA Associate Administrator for Manned Space Flight George E. Mueller informed MSC Director Robert R. Gilruth that the MSC Procurement Plan for procurement of three lunar landing training vehicles and the proposed flight test program was approved.

Ltr., Mueller to Gilruth, Aug. 1, 1966.

1 NASA signed a supplemental agreement with Chrysler Corp.'s Space Division at New Orleans, La., converting the uprated Saturn I first-stage production contract from cost-plus-fixed-fee to cost-plus-incentive-fee. Under the agreement, valued at \$339 million, the amount of the contractor's fee would be based on ability to perform assigned tasks satisfactorily and meet prescribed costs and schedules. The contract called for Chrysler to manufacture, assemble and test 12 uprated Saturn I first stages and provide system engineering, integration support, ground support equipment, and launch services.

NASA News Release 66-201, "Agreement with Chrysler Converts Saturn I Contract to Incentive-Type," Aug. 1, 1966.

3 The architect-engineer of the Lunar Receiving Laboratory, Smith, Hinchman & Grylls, proposed using a much darker tint in the exterior windows of the LRL than used in other buildings at MSC. J. G. Griffith, Chief of the Engineering Office, inspected samples of the glass and reported:

- a. when the building is viewed from the exterior, the windows might seem slightly darker than others at MSC.
- b. the ability of personnel inside to see through the glass was not restricted but brightness was considerably reduced.
- c. heat transfer through the glass would be reduced by about 40 percent from glass used in other windows at MSC.

Memo, Program Manager, LRL, to Deputy Director, MSC, "Exterior windows of the Lunar Receiving Laboratory," Aug. 3, 1966.

3 MSC requested LaRC to study the visibility of the S-IVB/SLA combination from the left-hand couch in the command module with the couch in the docked position. (Two positions could be attained, one of them a docking and rendezvous position that moved the seat into a better viewing area from the left-hand window.) LM and CM mockups were already at Langley from the CM-active moving-base docking simulation conducted May-July 1965.

1966
August

The request was initiated because the flight crew had to rely on an out-the-window reference of the S-IVB/SLA to verify separation of the LM/CSM combination from the S-IVB/SLA. The question arose as to whether the out-the-window reference was sufficient or whether an electromechanical device with a panel readout in the CM was required to verify separation.

Ltr., Director, MSC, to LaRC, Attn: Floyd L. Thompson, Director. "Apollo visibility study," Aug. 3, 1966.

NASA modified its contract with IBM to provide for work to be performed under a multiple-incentive arrangement covering cost, performance, schedule and equipment management. It also ordered the Real Time Computer Complex (RTCC) at MSC to be converted to IBM System computers, which would increase the operational capability for Apollo. The contract with IBM's Federal Systems Division, Gaithersburg, Md., provided the computing capability required for mission monitoring, inflight mission planning and simulation activities.

NASA News Release 66-205, "Apollo Complex to Be Converted in IBM Contract," Aug. 3, 1966.

Maxime A. Faget, MSC, informed Center Director Robert R. Gilruth there was a continuing effort on lightweight, energy-absorbing, and stowable net couches, and development had been redirected to a nonelastic fabric net couch system attached to existing Apollo attenuation struts. North American Aviation had previously been given the task of investigating the use of net couches on Apollo. Results of that investigation indicated the spacecraft attenuation-strut-vehicle attachments would be overloaded when using net couches. The North American Aviation investigators made their calculations by assuming no-man attenuation in the lateral and longitudinal force directions. Those calculations were recomputed using the design criteria and proper loadings and the results indicated no overloading when using net couches. MSC's Advanced Spacecraft Technology Division had reviewed and approved the efforts, permitting use of the net couches on Apollo and Apollo Applications missions.

Memo, Faget to Gilruth, "Net couches for Apollo or Apollo Applications Missions," Aug. 5, 1966.

MSC requested Ames Research Center to conduct a manual control simulation of the Saturn V upper stages with displays identical to those planned in the spacecraft. On August 5, Brent Creer and Gordon Hardy of Ames had met with representatives from ASPO, Guidance and Control Division, and Flight Crew Operations Directorate to discuss implementation of a modified Ames simulation which would determine feasibility of manual control from first stage burnout, using existing spacecraft displays and control interfaces. Simulations at Ames in 1965 had indicated that the Saturn V could be manually flown into orbit within dispersions of 914 meters in altitude, and 0.1 degree in flight path angle.

1966**August**

Ames responded on August 24 that setting up the flight simulator had been initiated and that the project was proceeding according to a schedule arranged by Warren J. North of MSC and Creer.

Memo, Chief, Flight Crew Support Div., "Saturn V. Manual Control," Aug. 8, 1966; ltrs., Robert R. Gilruth, Director MSC, to H. Julian Allen, Director, Ames Research Center, Aug. 8, 1966; Allen to Gilruth, Aug. 24, 1966.

9

MSC worked out a program with LaRC for use of the Lunar Landing Research Facility (LLRF) for preflight transition for LM flight crews before free-flight training in the lunar landing training vehicle. LM hardware sent to Langley to be used as training aids included two flight director attitude indicators, an attitude controller assembly, a thrust-translation controller assembly, and an altitude-rate meter.

Memo, George C. Franklin, MSC, to W. A. Lee, MSC, "Status of Lunar Module hardware for Langley Research Center Lunar Landing Research Facility (LaRC LLRF)," Aug. 9, 1966.

**August 10–
September 14**

Lunar Orbiter I was launched from Cape Kennedy Launch Complex 13 at 3:26 p.m. EDT August 10 to photograph possible Apollo landing sites from lunar orbit. The Atlas-Agena D launch vehicle injected the spacecraft into its planned 90-hour trajectory to the moon. A midcourse correction maneuver was made at 8 p.m. the next day; a planned second midcourse maneuver was not necessary. A faultless deboost maneuver on August 14 achieved the desired initial elliptic orbit around the moon, and one week later the spacecraft was commanded to make a transfer maneuver to place it in a final close-in elliptic orbit of the moon.

During the spacecraft's stay in the final close-in orbit, the gravitational fields of the earth and the moon were expected to influence the orbital elements. The influence was verified by spacecraft tracking data, which showed that the perilune altitude varied with time. From an initial perilune altitude of 58 kilometers, the perilune decreased to 49 kilometers. At this time an orbit adjustment maneuver began an increase in the altitude, which was expected to reach a maximum after three months and then begin to decrease again. The spacecraft was expected to impact on the lunar surface about six months after the orbit adjustment.

During the photo-acquisition phase of the flight, August 18 to 29, *Lunar Orbiter I* photographed the 9 selected primary potential Apollo landing sites, including the one in which *Surveyor I* landed; 7 other potential Apollo landing sites; the east limb of the moon; and 11 areas on the far side of the moon. *Lunar Orbiter I* also took photos of the earth, giving man the first view of the earth from the vicinity of the moon (this particular view has been widely publicized). A total of 207 frames (sets of medium- and high-resolution pictures) were taken, 38 while the spacecraft was in initial orbit, the remainder while it was in the final close-in orbit. *Lunar Orbiter I* achieved its mission objectives, and, with the exception of the high-resolution camera, the performance of the photo subsystem and other spacecraft subsystems was outstanding. At the completion of the photo

readouts, the spacecraft had responded to about 5000 discrete commands from the earth and had made about 700 maneuvers.

1966

August

Photographs obtained during the mission were assessed and screened by representatives of the Lunar Orbiter Project Office, U.S. Geological Survey, DOD mapping agencies, MSC, and Jet Propulsion Laboratory.

Memo, NASA Associate Administrator for Space Science and Applications to Administrator, "Lunar Orbiter I Post Launch Report," Oct. 20, 1966 (Mission Operation Report S-814-66-01, Oct. 19, 1966).

MSC suggested that Grumman Aircraft Engineering Corp. redesign the injector for the Bell Aerospace Co. ascent engine as a backup immediately. The Center was aware of costs, but the seriousness of the injector fabrication problem and the impact resulting from not having a backup was felt to be justification for the decision.

11

TWX, MSC to Grumman, Aug. 11, 1966.

The mockup of LM test model No. 3 (TM-3) was shipped by *Super Guppy* aircraft to Cape Kennedy, on the first trip of the *Super Guppy* from Grumman, Bethpage, N.Y.

16

Memo, Frank X. Battersby to Chief, Apollo Procurement Br., Procurement and Contracts Div., MSC, "Weekly Activity Report, BMR Bethpage, Week Ending August 19, 1966," Aug. 24, 1966.



Five F-1 rocket engines, above, are installed in the massive first flight S-IC stage of the Saturn V launch vehicle at NASA's Michoud Operations plant in New Orleans. At right, an F-1 engine is tested in the NASA High Thrust Test Area, Edwards, California. The rockets were developed under Marshall Space Flight Center direction by Rocketdyne Division of North American. Rocketdyne photos.



1966
August
22

In a letter to the President of Westinghouse Electric Corp., George M. Low, Acting Director of MSC, expressed his concern about the lunar television camera program. Low pointed out that Westinghouse had been awarded the contract by MSC in October 1964, that delivery of the cameras was to be made over a 15-month period, and that the total value of the original cost-plus-fixed-fee contract was \$2 296 249 including a fee of \$150 300. The cost reports required by the contract (at the time of Low's letter) showed that Westinghouse estimated the cost to complete at \$7 927 000 and estimated the hardware delivery date as January 31, 1967. Low pointed out that the proposal letter from Westinghouse in May 1964 stated that "the Aerospace Division considers the Lunar Television Camera to represent a goal culminating years of concentrated effort directed toward definition, design, and verification of critical elements of this most important program. Accordingly, the management assures NASA Manned Spacecraft Center that the program will be executed with nothing less than top priority application of all personnel, facilities, and management resources." Low said that despite these assurances the overrun and schedule slippages indicated a lack of adequate program management at all levels and a general lack of initiative in taking corrective actions to solve problems encountered.

Westinghouse replied to Low on September 1 that it, too, was disappointed "when technology will not permit a research and development program such as this to be completed within its original cost and schedule objectives." The reply stated "Our people have taken every precaution—gone to the extreme, perhaps, in its impact on cost and schedule—to achieve the required mission reliability. . . ." The letter concluded by expressing pleasure in the harmony that had existed between Westinghouse and MSC personnel and by praising the performance of the Gemini rendezvous radar, holding it up as an objective for excellence of performance for the lunar television camera.

Ltrs., Low to D. C. Burnham, President, Westinghouse Electric Corp., Aug. 22, 1966; Charles H. Weaver, Group Vice President, Atomic, Defense & Space Group, Westinghouse Electric Corp., to Low, Sept. 1, 1966.

22

MSC Director Robert R. Gilruth requested of Jet Propulsion Laboratory Director William H. Pickering that JPL fire the Surveyor spacecraft's vernier engine after the Surveyor landed on moon, to give insight into how much erosion could be expected from an LM landing. The LM descent engine was to operate until it was about one nozzle diameter from landing on the lunar surface; after the Surveyor landed, its engine would be about the same distance from the surface. Gilruth told Pickering that LaRC was testing a reaction control engine to establish surface shear pressure forces, surface pressures, and back pressure sources, and offered JPL that data when obtained.

Ltr., Gilruth to Pickering, "Surveyor spacecraft experiments," Aug. 22, 1966.

NASA informed four firms that had completed design studies on the Apollo experiment pallet that there would be no hardware development and fabrication of the pallet. The four firms had been selected in November 1965 to make four-month studies of a pallet to carry experiments in the spacecraft SM during the Apollo manned lunar landings. The firms were Lockheed Missiles and Space Co., Sunnyvale, Calif.; The Martin Co., Denver, Colo.; McDonnell Aircraft Corp., St. Louis, Mo.; and Northrop Space Laboratories, Hawthorne, Calif. (See April 15.)

1966
August
22

NASA News Release 66-224, "Apollo Pallet Development Phase Vetoed," Aug. 22, 1966.

The unmanned suborbital Apollo-Saturn 202 mission was successfully flown—the third Saturn IB flight test and the second CM heatshield flight test. The 202 included an uprated Saturn I (Saturn IB) launch vehicle (S-IB stage, S-IVB stage, and instrument unit) and the Apollo 011 spacecraft (spacecraft-lunar module adapter, service module, command module, and launch escape system). Liftoff was from Launch Complex 34 at Cape Kennedy at 1:15 p.m. EDT. The command module landed safely in the southwest Pacific Ocean, near Wake Island 1 hour 33 minutes after liftoff. It was recovered by the U.S.S. *Hornet* about 370 kilometers uprange from the recovery ship.

25

Spacecraft 011 was essentially a Block I spacecraft with the following exceptions: couches, crew equipment, and the cabin postlanding ventilation were omitted; and three auxiliary batteries, a mission control programmer, four cameras, and flight qualification instrumentation were added.

Of six primary test objectives assigned to the mission (see Appendix 5), the objectives for the environmental control, electrical power, and communications subsystems were not completely satisfied. All other spacecraft test objectives were successfully accomplished.

"MSC-A-R-66-5, Postlaunch Report for Mission AS-202 (Apollo Spacecraft 011)," MSC, Oct. 12, 1966, pp. 1-1, 2-1, 3-1; memo, Associate Administrator for Manned Space Flight to Administrator, "Apollo Saturn Flight Mission AS-202, Post Launch Report No. 1" (Mission Operations Report M-932-66-03), Sept. 1, 1966.

The Bethpage RASPO Business Manager and Grumman representatives met to choose a vendor to produce the orbital rate drive electronics for Apollo and LM (ORDEAL). Three proposals were received: Arma Division of American Bosch Arma Corp., \$275 000; Kearfott Products Division of General Precision, Inc., \$295 000; and Bendix Corp., \$715 000. Kearfott's proposal was evaluated as offering a more desirable weight, more certain delivery, and smaller size within the power budget and consequently was selected although it was not the low bid. Evaluators believed that Arma's approach would not be easy to implement, that its delivery schedule was

Week
Ending
August 26

1966
August

unrealistic, and that its proposal lacked a definite work statement in the areas of testing, quality control, reliability, and documentation.

Memo, Frank X. Battersby to Chief, Apollo Procurement Br., Procurement and Contracts Div., MSC, "Weekly Activity Report, BMR Bethpage, Week Ending August 26, 1966," Aug. 31, 1966.

26

Because of the reported NASA OMSF rejection of funding responsibility for prototyping and equipping the Lunar Receiving Laboratory (LRL) and the strong NASA Office of Space Science and Applications concern over the quarantine facilities and techniques, Craig K. Peper of OSSA suggested that (1) each concerned program office make a scientific review of OMSF's proposal for facility construction to determine its adequacy to meet the scientific requirements and (2), from those reviews the Director of Manned Space Flight Experiments, OSSA, would submit to the Associate Administrator, OSSA, a consolidated recommendation on additional requirements to satisfy the scientific standards the LRL facilities must meet.

Memo, Peper, NASA Hq., to Director, Manned Flight Experiments, OSSA, "Lunar Receiving Laboratory," Aug. 26, 1966.

29

MSC's Flight Crew Support Division prepared an operations plan describing division support of flight experiments. Activities planned would give operational support to both flight crew and experimenters. Crew training, procedures development, and integration, mission-time support, and postmission debriefings were discussed in detail.

Memo, Warren J. North, MSC, to Technical Assistant for Apollo, "Flight Experiments Operations Plan of the Flight Crew Support Division," Aug. 22, 1966.

30

Because the Apollo Mission Simulator (AMS) was one of the pacing items in the Apollo Block II flight program, a critical constraint upon operational readiness was the availability of Government-furnished equipment (GFE) to the AMS contractor, General Precision's Link Group. For that reason MSC ASPO Manager Joseph F. Shea asked A. L. Brady, Chief of the Apollo Mission Simulator Office, to establish controls to ensure that GFE items were provided to Link in time to support the program. He requested that an individual be appointed to be responsible for each item and that a weekly report on the status be submitted on each item.

Memo, Shea to Manager, Apollo Mission Simulator Program, "GFE Support to AMS Block II Modifications," Aug. 30, 1966.

31

MSC Director of Flight Crew Operations Donald K. Slayton informed ASPO Manager Joseph F. Shea that total management during thermal vacuum testing of spacecraft 008 was inadequate, resulting in misunderstandings between personnel and organizational groups concerned with the test. Slayton offered a number of suggestions for future, similar tests:

- Overall planning policies and practices should be reviewed and further defined before commitment of future test crews.

- Timeline testing philosophy was not realistic or practical in a one-g environment. It was mandatory that test plans be developed with maximum data gain and minimum crew and hardware risks consistent with overall program objectives. For example, long thermal responses during manned tests.

- A crew systems operations office should be established within the Space Environmental Simulation Laboratory to tie down the interface between crew, hardware, and management. Its scope of operation should include representation, training, and scheduling.

- The Environmental Medicine Office should define all crew and test medical requirements before crew selection. To help in this area, a flight surgeon should be assigned to each vehicle's prime and backup crews, to ensure adequate knowledge of crew members and test objectives for training and the real-time mission.

- It must be recognized that test crew participation in thermal vacuum testing was completely voluntary and that each member volunteering must weigh the hazards of such testing against the benefits to the program in general and his welfare in particular.

Memo, Slayton to Shea, "Management improvement of follow-on thermal vacuum testing," Aug. 31, 1966.

In response to a query from NASA Deputy Administrator Robert C. Seamans, Jr., Associate Administrator for Space Science and Applications Homer E. Newell said that no laboratories had been selected for receiving lunar materials but proposals had been solicited and were in process of review. Newell said the lunar samples fell under the planetary and planetary biology disciplines primarily. The Planetary Biology Subcommittee of the Space Science Steering Committee had four working groups evaluating the proposals—geophysics, geochemistry, geology, and Lunar Receiving Laboratory (LRL). The working groups were expected to complete their evaluations in September and, following review by the program office, recommendations would be prepared for the Space Science Steering Committee. Following appropriate review by that Committee, Newell would select the Principal Investigators for approved experiments.

Funding for the analyses could be determined only after selections had been made, but budget estimates for that purpose had been made for \$2 million in FY 1968 and \$6 million in FY 1969, exclusive of laboratory upgrading and funding of the LRL. As a part of the continuing research effort, 33 laboratories had received support during 1966 for upgrading their ability to handle and examine lunar material. Newell added that 125 proposals for handling lunar material had been received and were under review.

Memo, Newell to Seamans, "Lunar Sample Analysis Program," Sept. 7, 1966.

MSC Deputy Director George M. Low submitted information to NASA Associate Administrator for Manned Space Flight George E. Mueller on manpower requirements and operating costs for testing in MSC's large

1966

August

September

7

14

1966
September

thermal vacuum chamber. Spacecraft 008 testing reflected a manpower cost (civil service and contractor) of \$7 034 000, chamber operating cost of \$321 000, and material costs of \$277 000. The spacecraft had been in the chamber 83 days, during which time a 92-hour unmanned test and a 163-hour manned test had been conducted.

Ltr., Low to Mueller, Sept. 14, 1966.

20

Surveyor II was launched from Cape Kennedy at 8:32 a.m. EDT. The Atlas-Centaur launch vehicle placed the spacecraft on a nearly perfect lunar intercept trajectory that would have missed the aim point by about 130 kilometers. Following injection, the spacecraft successfully accomplished all required sequences up to the midcourse thrust phase. This phase was not successful because of the failure of one of the three vernier engines to ignite, causing eventual loss of the mission. Contact with the spacecraft was lost at 5:35 a.m. EDT, September 22, and impact on the lunar surface was predicted at 11:18 p.m. on that day.

Memo, Associate Administrator for Space Science and Applications to Administrator, "Surveyor II Lunar Flight Project, Post Launch Report No. 1," Oct. 7, 1966 (Mission Operation Report S-803-66-02).

21

NASA awarded a \$4.2-million contract to Honeywell, Inc., Computer Control Division, Framingham, Mass., to provide digital computer systems for Apollo command and lunar module simulators. Under the fixed-price contract, Honeywell would provide six separate computer complexes to support the Apollo simulators at MSC and Cape Kennedy. The complexes would be delivered, installed, and checked out by Honeywell by the end of March 1967.

NASA News Release 66-254, Sept. 21, 1966.

23

A Planning Coordination Steering Group at NASA Hq. received program options from working groups established to coordinate long-range planning in life sciences, earth-oriented applications, astronomy, lunar exploration, and planetary exploration. The Steering Group recommended serious consideration be given a four-phase exploration program using unmanned Lunar Orbiters, Surveyors, and manned lunar surface exploration. The first phase, consisting of Ranger, Surveyor, Orbiter, and the initial Apollo landing was under way. The second phase would match the Apollo Applications program and would extend surface sampling and geologic mapping beyond the walking capability of a suited astronaut. The group recommended this phase launch one 14-day two-man mission per year beginning in 1970, with one or two Surveyors, and one unmanned Orbiter per year. The third phase would consist of one three-man 90-day mission per year. The final phase would consist of semipermanent manned stations.

Memo, Edgar M. Cortright, Alfred J. Eggers, Jr., James C. Elms, and Gerald M. Truszynski, Cochairmen, Planning Coordination Steering Group, to Associate Deputy Administrator, "Preliminary Reports of Working Groups," Sept. 23, 1966.

NASA Hq. informed MSC that the second phase of the vacuum system in the Lunar Receiving Laboratory (\$480 200) was to be deferred because of the austerity of the NASA FY 1967 program. MSC was instructed, however, that sufficient redundancy in the central vacuum pumping systems should be provided to ensure the highest degree of reliability.

1966
September
28

TWX, NASA Hq., to MSC, "Lunar Receiving Laboratory," Sept. 28, 1966.

MSC ASPO Manager Joseph F. Shea wrote Grumman Aircraft Engineering Corp. Senior Vice President George F. Titterton that he was encouraged by the good start Grumman had made on work packages for the LM program, which he hoped had set the stage for effective action to curtail the creeping cost escalation that had characterized the program during the past year. He said: "To me, the most striking point noted in engineering activities projected a relatively high change rate from vehicle to vehicle, even though the program logic calls for identical vehicles from LM 4 on, and minimum change from LM 3 to LM 4. This, too, was apparent in the engineering related activities. The only changes which should be planned for are those rising from hardware deficiencies found in ground or flight test, or those resulting from NASA directed changes."

28

Shea had written to Joseph G. Gavin, Jr., Grumman Vice President and LEM Program Manager, in April concerning cost escalation. He had said "A significant amount of the planning for your contract is based upon management commitments made to us by Grumman . . . [and] your estimates have helped significantly (and indeed are still changing) and currently significantly exceed the amounts upon which our budget has been based." In another letter, in September, to Grumman President L. J. Evans, Shea remarked: "The result of our fiscal review with your people last week was somewhat encouraging. It reconfirmed my conviction that Grumman can do the program without the cost increases which you have been recently indicating, and, depending on how much difficulty we have with the qualification of our flight systems, perhaps even with some additional cost reduction."

In a November letter to Titterton, Shea again referred to work packages and reaffirmed that permission to exceed approved monthly levels should be granted only by the LM Program Office. He said, "Unless this discipline is enforced throughout the Grumman in-house and subcontract structure, the work packages could turn out to be interesting pieces of paper which contain the information as to what might have been done, rather than the basis for program management."

Ltrs., Shea to Gavin, Apr. 14, 1966; Shea to Evans, Sept. 19, 1966; Shea to Titterton, Sept. 28, 1966; Nov. 18, 1966.

The second planned manned Apollo flight crew was named by NASA. Prime crew members were Walter M. Schirra, Jr., command pilot; Donn F. Eisele, senior pilot; and R. Walter Cunningham, pilot. Backup crewmen

29

1966
September

were Frank Borman, command pilot; Thomas P. Stafford, senior pilot; and Michael Collins, pilot. The flight was scheduled for 1967. It would be the first space mission for Eisele and Cunningham.

The second manned Apollo mission was planned as an open-ended earth orbital mission up to 14 days. Increased emphasis on scientific experiments as well as repeating some activities from the first planned manned flight would characterize the mission. [The first planned manned Apollo mission was ended by a tragic accident during a test January 27, 1967.]

NASA News Release 66-260, Sept. 29, 1966.

Week
Ending
September 30

LM test model TM-6 and test article LTA-10 were shipped from Grumman on the *Pregnant Guppy* aircraft. When the *Guppy* carrying the LTA-10 stopped at Dover, Del., for refueling, a fire broke out inside the aircraft, but it was discovered in time to prevent damage to the LM test article.

Memo, Frank W. Battersby to Chief, Apollo Procurement Br., Procurement and Contracts Div., MSC, "Weekly Activities Report, BMR Bethpage, Week Ending September 30, 1966," Oct. 4, 1966.

October
4

MSC Director Robert R. Gilruth told Langley Research Center Director Floyd Thompson, "Lunar Orbiter I has made significant contributions to the Apollo program and to lunar science in general. Details visible for the first time in Orbiter I photographs will certainly add to our knowledge of the lunar surface and improve our confidence in the success of the Apollo landing.

"Screening teams . . . are studying the photographs as they become available at the Lunar Orbiter Project Office, Langley Research Center. Several promising areas for Apollo landing sites have been studied here in Houston by the screening teams and will be studied in more detail later. This preliminary study has already influenced the selection of sites to be photographed on the next Orbiter mission. . . ."

TWX, Gilruth to Thompson, Oct. 4, 1966.

7

NASA Associate Administrator for Manned Space Flight George E. Mueller, at the conclusion of the AS-204 Design Certification Review (DCR), requested each NASA manager to reexamine his stages, modules, systems, and subsystems upon substantial completion of the review's closeout actions and to file an updated certification statement to the Design Certification Board.

On November 16, Apollo Program Director Samuel C. Phillips asked ASPO Manager Joseph F. Shea to submit the updated certification statements and supporting data to him by December 14 to permit him to submit the statements and his affirmation to the Board before the December 20 Manned Space Flight Review. He pointed out that each certification statement should affirm: (1) that the reservations previously cited had been dispelled by appropriate action; (2) that design problems identified subsequent to the



The manufacturing line for thrust chambers of the F-1 rocket engine shows the size of the powerful engine. Five of the engines were used in a cluster to launch each of the Saturn V space vehicles. Rocketdyne photo.

review had been resolved; (3) that actions identified during the review had been completed (except where specifically noted); and (4) that his previous certification of the design of flight systems for flight worthiness and manned safety, or of the capability of Launch Support to support a manned mission, remained valid. Any residual contingencies or actions, scheduled for completion at the Flight Readiness Review, should be specifically listed.

Ltr., Phillips to Shea, "AS-204 Design Certification Review," Nov. 16, 1966.

In a memorandum to the NASA Deputy Administrator, Associate Administrator for Manned Space Flight George E. Mueller commented on the AS-202 impact error. Mueller said trajectory of the August 25 AS-202 mission was essentially as planned except that the command module touched down about 370 kilometers short of the planned impact point. A detailed study indicated that the command module had a lower than predicted angle of attack and a correspondingly lower lift-to-drag ratio. "In retrospect, it appears that our wind tunnel testing did not provide a complete understanding of . . . hypersonic aerodynamic characteristics of the command module." Plans were being made to fly AS-204 and AS-205 with the lower lift-to-drag ratio.

Memo, Mueller to Deputy Administrator, "205 Nautical Mile Error in AS-202 Impact," Oct. 7, 1966.

1966
October

7

1966
October
11

Apollo Program Director Samuel C. Phillips was informed of increasing engineering orders for spacecraft 012. C. H. Bolender, OMSF Mission Operations Deputy Director, reported information received from John G. Shinkle, Kennedy Space Center Apollo Program Manager, on October 10. At the time of spacecraft shipment to Cape Kennedy on August 25, 164 engineering orders were identified as open work, although the data package appeared to identify only 126. These orders were covered by 32 master change records, which reportedly were the documentation approved by the MSC Change Control Board rather than by individual engineering orders. By September 24, engineering orders totaled 377—213 more than on August 25—and the master change records had increased to 77. KSC estimated that some 150 of the 213 additional orders should have been identifiable within North American Aviation at the time of the Customer Acceptance Readiness Review. Bolender said that, if this were true, North American Aviation should be asked to provide better visibility for CSM changes that would be sent to the Cape for installation at the time of the review.

Memo for Record, Shinkle, KSC, "Engineering Orders for Spacecraft 012," Oct. 11, 1966; NASA Routing Slip, Bolender to Phillips, Oct. 11, 1966.

11

NASA reiterated its intention of examining the question of tracking ship *Vanguard* support for the AS-204 mission in the South Pacific as soon as mission plans were resolved. It informed the Department of Defense Manager for Manned Space Flight Support Operations, the Navy Deputy Commander for Ship Acquisitions, and Goddard Space Flight Center that plans could not be completed for the support of AS-205 at the time but, should the services of the *Vanguard* be required, an Atlantic Ocean location would be acceptable. NASA also expressed concern about the late delivery forecast for the *Redstone* and the *Mercury* tracking ships and requested top management attention within government, contractor, and subcontractor organizations be directed to the problems and that a special effort be made to accelerate delivery.

TWX, NASA Hq. to Lt. Gen. Leighton I. Davis, Rear Admiral J. Adair, and Goddard Space Flight Center, Oct. 11, 1966.

12

MSC Apollo Spacecraft Program Office Manager Joseph F. Shea reported that LM-1 would no longer be capable of both manned and unmanned flight and that it would be configured and checked out for unmanned flight only. In addition, LM-2 would no longer be capable of completely unmanned flight, but would be configured and checked out for partially manned flights, such as the planned AS-278A mission (with unmanned final depletion burn of the ascent stage) and AS-278B (with all main propulsions unmanned).

Memo, Shea to distr., "Change in policies for LM-1 and LM-2," Oct. 12, 1966.

12

Apollo Program Director Samuel C. Phillips told Mark E. Bradley, Vice President and Assistant to the President of The Garrett Corp., that "the environment control unit, developed and produced by Garrett's AiResearch



Apollo CM 007 bobs in the swells of the Gulf of Mexico during 1966 tests for the lunar missions. Three test subjects from Manned Spacecraft Center remained in the spacecraft 48 hours during the sea-qualification test of postlanding systems.

Division under subcontract to North American Aviation for the Apollo spacecraft was again in serious trouble and threatened a major delay in the first flight of Apollo.” He pointed out, “This current difficulty is the latest in a long string of failures and problems associated with the AiResearch equipment.” Phillips told Bradley that he was about three levels removed from the subcontract project details and thus could not give him a point by point discussion of the problems or their causes. Phillips felt, however, “they seem to lie in two categories—those arising from inadequate development testing, and those related to poor workmanship.” Phillips hoped that Bradley could find what was needed to get the project on the right track.

Ltr., Phillips to Bradley, Oct. 12, 1966.

KSC proposed to MSC Director Robert R. Gilruth that the two General Electric Co. efforts at KSC supporting automatic checkout equipment (ACE) for spacecraft operations be consolidated. KSC pointed out there was a supplemental agreement with MSC for General Electric to provide system engineering support to ACE/spacecraft operations. Both the KSC Apollo Program Manager and the Director of Launch Operations considered that merging the two GE efforts into a single task order under KSC administrative control would have advantages. The proposal listed two:

1966
October

13

1966
October

1. A single interface would exist between KSC and all local GE AEC/spacecraft operations.
2. Through more efficient use of personnel, the contractor should be able to reduce the manpower level and still be responsive to the demands of the Apollo program.

Gilruth replied Nov. 1 to KSC Director Kurt H. Debus that MSC had evaluated advantages of transferring certain ACE/spacecraft responsibilities to KSC and had also considered advantages of continuing the existing system. These advantages were:

1. "To maximize manpower utilization, the current ACE management philosophy provides only optimum manpower for each operational site. A central support group, located at Houston, supplies the required support to any site experiencing special peak activity. This philosophy has created maximum management flexibility."
2. "The original intent in establishing ACE-S/C checkout philosophy was to assure standardization in checkout procedures and/or program unity from factory checkout through launch activities. By continuing to have all GE ACE-S/C site personnel responsible to the central design/engineering group located in Houston, this continuity is assured."
3. "Logistics support to KSC ground stations is unified under the present management control. Personnel responsible for providing logistics support to KSC ground stations are administratively linked to the personnel at KSC requiring the support."
4. "MSC currently provides reliability support, configuration management support, engineering support, management support and logistics support to all ACE-S/C ground stations. By continuing the present contractual arrangement we avoid the possibility of costly duplication in these areas."

Gilruth said that it was the MSC intent to support system engineering requirements in ACE/spacecraft areas and that further support in these areas was normally supplied by the spacecraft contractor. "Actually it has been our impression that GE/MSFC ACE/spacecraft support at KSC and all other locations was sufficient to meet all requirements. . . . It is our opinion that the existing ACE/spacecraft management organization is required to assure optimum fulfillment of the Apollo program."

Ltrs., Debus to Gilruth, Oct. 13, 1966; Gilruth to Debus, Nov. 1, 1966.

19

Marshall Space Flight Center Director Wernher von Braun wrote MSC Director Robert R. Gilruth that MSFC had spent a considerable effort in planning the transfer of study and development tasks in the lunar exploration program to MSC. Von Braun said, "We feel it is in the spirit of the MSF Hideaway Management Council Meeting held on August 13-15, 1966, to consider the majority of our Lunar Exploration Work Program for transfer to MSC in consonance with Bob Seamans' directive which designates MSC as the Lead Center for lunar science." He added that MSFC

had formulated a proposal which it felt was in agreement with the directives and at the same time provided for management interfaces between the two Centers without difficulty.

1966
October

Briefly MSFC proposed to transfer to MSC (1) planning for Apollo Applications lunar traverses; (2) lunar surface geological, geophysical, geochemical, biological, and biomedical experiments; and (3) emplaced scientific station experiments. MSFC proposed to retain (1) the local scientific survey module and related mobility efforts, (2) Apollo Applications program lunar drill, (3) lunar surveying system, and (4) lunar flying device (one man flying machine). He added that MSFC had been working in specific areas of scientific technology that promised to furnish experiments that could be used on the lunar surface or from lunar orbit as well as from a planetary vehicle for planetary observations. Among these were radar and laser altimetry and infrared spectroscopy.

Von Braun said that Ernst Stuhlinger of the Research Projects Laboratory had discussed the proposed actions for transfer of functions to MSC, and MSC Experiments Program Manager Robert O. Piland had indicated his general agreement, pending further consideration. He asked that Gilruth give his reaction to the proposal and said, "It would be very helpful if our two Centers could present a proposal to George Mueller [OMSF] on which we both agree."

Ltr., von Braun to Gilruth, Oct. 19, 1966.

Apollo-Saturn 204 was to be the first manned Apollo mission, NASA announced through the manned space flight Centers. The news release, prepared at NASA Hq., said the decision had been made following a Design Certification Review Board meeting held the previous week at OMSF. The launch date had not been determined. Crewmen for the flight would be Virgil I. Grissom, command pilot; Edward H. White II, senior pilot; and Roger B. Chaffee, pilot. The backup crew would be James A. McDivitt, command pilot; David R. Scott, senior pilot; and Russell L. Schweickart, pilot. The AS-204 spacecraft would be launched by an uprated Saturn I launch vehicle on its earth-orbital mission "to demonstrate spacecraft and crew operations and evaluate spacecraft hardware performance in earth orbit."

19

TWX, NASA Hq. M-N-311 to KSC, MSC, MSFC, Oct. 19, 1966.

MSC's ASPO Manager Joseph F. Shea proposed to KSC Apollo Program Manager John G. Shinkle that—because the program was moving into the flight phase and close monitoring of the hardware configuration was important—they should plan work methods in more detail. He reminded Shinkle that he had named Walter Kapryan Assistant Program Manager "to provide the technical focal point . . . to maintain the discipline for the total spacecraft"; therefore Shea would like to transfer the chairman of the Apollo

21

1966
October Configuration Control Panel from Shinkle's organization to Kapryan effective Nov. 1, 1966.

Ltr., Shea to Shinkle, Oct. 21, 1966.

21 Langley Research Center informed MSC that the Apollo Visibility Study requested by MSC would be conducted. Langley mockups could be used along with an SLA panel to be provided by MSC from Tulsa North American. The proposed study would be semistatic, with the astronaut seated in the existing CM mockup and viewing the S-IVB/SLA mockup. The positions of the mockups would be varied manually by repositioning the mockup dollies, and the astronaut would judge the separation distance and alignment attitude. The study was expected to start at the end of October or early November and last two or three weeks.

Ltr., Director, LaRC, to MSC, Attn: Robert R. Gilruth "Apollo Visibility Study," Oct. 21, 1966.

24 MSC established a committee to investigate several nearly catastrophic malfunctions in the steam generation system at the White Sands Test Facility. The system was used to pump down altitude cells in LM propulsion system development. Committee members were Joseph G. Thibodaux, chairman; Hugh D. White, secretary; Harry Byington, Henry O. Pohl, Robert W. Polifka, and Allen H. Watkins, all of MSC.

Memo, MSC Director to distr., "Committee for investigation of malfunctioning steam generation system at White Sands Test Facility, New Mexico," Oct. 24, 1966.

25 Propellant tanks of service module 017 failed during a pressure test at North American Aviation, Downey, Calif. The planned test included several pressure cycles followed by a 48-hour test of the tanks at the maximum operating pressure of 165 newtons per square centimeter (240 pounds per square inch). Normal operating pressure was 120 newtons per square centimeter (175 pounds per square inch). After 1 hour 40 minutes at 165 newtons the failure occurred.

SM 017 (designed for SA-501) had been pulled for this test after cracks had been detected in the tanks of SM 101. SM 017 had been previously proof-tested a short time (a matter of minutes) at 220 newtons per square centimeter (320 pounds per square inch).

A team was set up at North American Aviation to look into the failure and its possible impact on the Saturn IB and Saturn V Apollo missions. MSC had two observers on the team, which was to make its findings and recommendations available by November 4.

North American Aviation identified the problem as stress-corrosion cracking resulting from use of methanol as a test liquid at pressures causing above threshold stresses. No tanks subjected to methanol at high stress levels would be used. Freon and isopropyl alcohol, respectively, were recommended for test fluids in the oxidizer and fuel systems, with the stipulation

that the equipment had not previously seen propellant and would receive a hot gaseous nitrogen purge after completion of the cold flow operation.

Note, Frank Magliato, NASA Hq., to NASA Administrator and Deputy Administrator, "Test Failure of Service Module 017," Oct. 26, 1966; TWX, Dale D. Myers, NA, to J. F. Shea, MSC, Nov. 11, 1966.

1966
October

Owen E. Maynard, Chief of the MSC Missions Operations Division, said the flight operations plan had proposed communication constraints be resolved by reducing the accessible landing area on the lunar surface to a region permitting continuous communication with no restriction on vehicle attitude during descent and ascent. Maynard said, "Such a proposal is not acceptable." Contending interests were the desire to maintain communications in the early part of the descent powered flight and to avoid the definition of attitude restrictions in this region.

27

Acknowledging that both of these were desirable objectives, Maynard said that mission planning should be based on access to previously defined Apollo zones of interest and to designated sites within those zones with vehicle attitude maneuvers to provide communications when required.

Memo, Maynard to distr., "LM communication capability during lunar descent and ascent," Oct. 27, 1966.

NASA Apollo Program Director Samuel C. Phillips indicated his concern to MSC over the extensive damage to a number of fuel cell modules from operational errors during integrated system testing. Phillips pointed out that in addition to the added cost there was a possible impact on the success of the flight program. He emphasized the importance of standardizing the procedures for fuel cell activation and shutdown at North American Aviation, MSC, and KSC to maximize learning opportunities.

November
4

TWX, MAT-91, NASA Hq., to MSC, Attn: Joseph F. Shea, "Fuel Cell Operation Failures," Nov. 4, 1966.

Lunar Orbiter II was launched at 6:21 p.m. EST from Launch Complex 13 at Cape Kennedy, to photograph possible landing sites on the moon for the Apollo program. The Atlas-Agena D booster placed the spacecraft in an earth-parking orbit and, after a 14-minute coast, injected it into its 94-hour trajectory toward the moon. A midcourse correction maneuver on November 8 increased the velocity from 3051 to 3133 kilometers per hour. At that time the spacecraft was 265 485 kilometers from the earth.

November 6–
December 6

The spacecraft executed a deboost maneuver at 3:26 p.m., November 10, while 352 370 kilometers from the earth and 1260 kilometers from the moon and traveling at a speed of 5028 kilometers per hour. The maneuver permitted the lunar gravitational field to pull the spacecraft into the planned initial orbit around the moon. On November 15, a micrometeoroid hit was detected by one of the 20 thin-walled pressurized sensors.

1966
November

The spacecraft was transferred into its final close-in orbit around the moon at 5:58 p.m. November 15 and the photo-acquisition phase of *Lunar Orbiter II*'s mission began November 18. Thirteen selected primary potential landing sites and a number of secondary sites were to be photographed. By the morning of November 25, the spacecraft had taken 208 of the 211 photographs planned and pictures of all 13 selected potential landing sites. It also made 205 attitude change maneuvers and responded to 2421 commands.

The status report of the *Lunar Orbiter II* mission as of November 28 indicated that the first phase of the photographic mission was completed when the final photo was taken on the afternoon of November 25. On November 26, the developing web was cut with a hot wire in response to a command from the earth. Failure to achieve the cut would have prevented the final readout of all 211 photos. Readout began immediately after the cut was made. One day early, December 6, the readout terminated when a transmitter failed, and three medium-resolution and two high-resolution photos of primary site 1 were lost. Full low-resolution coverage of the site had been provided, however, and other data continued to be transmitted. Three meteoroid hits had been detected.

Memos, Lunar Orbiter Program Manager to NASA Administrator, "Lunar Orbiter II Post Launch Report #1" through "#15," Nov. 7, 8, 14, 16, 17, 21, 25, and Dec. 9, 1966 (Mission Operation Reports S-814-66-02).

9 NASA Associate Administrator for Manned Space Flight George E. Mueller reported on technical feasibility and cost tradeoffs of real-time television coverage of Apollo missions. Deputy Administrator Robert C. Seamans, Jr., had requested an evaluation during a July 8 program review. Highlights of the report were:

- Lunar missions would be the most complex attempted in manned space flight. Even with optimum training, astronaut capabilities would be heavily taxed and availability of real-time TV coverage could provide an opportunity in trouble-shooting spacecraft anomalies or in performing scientific experiments.

- To transmit TV video to Mission Control Center in Houston, scan conversion from the Apollo format to the standard commercial format would be required as well as a communications capability. For the lunar mission, implementation at Goldstone and Madrid would provide 62- to 91-percent TV coverage with an estimated initial investment of \$500 000 and an operating cost of \$1 2000 000 per year, based on four seven-day missions per year with 8 to 14 hours a day possible coverage for each station.

- The most optimistic minimum procurement and installation time for the first unit would be 10 months and, to provide real-time TV for the first lunar mission, the system should be exercised at least one mission before AS-504. Mueller recommended approval for additional equipment and communication services necessary for live TV coverage from the Goldstone, Calif., and Madrid, Spain, stations.

PART I: PREPARATION FOR FLIGHT AND THE ACCIDENT

1966
November

Seamans approved the proposal on November 17, with the following condition, which was later transmitted to MSC Director Robert R. Gilruth: "Before NASA commitments of any sort are made to the networks for Apollo capsule TV coverage, the plans and procedures must be approved by the Administrator."

Ltr., NASA Associate Administrator for Manned Space Flight to Deputy Administrator, "Real Time TV Coverage of Apollo Missions," Nov. 9, 1966; approval, with condition, by Seamans, Nov. 17, 1966; NASA Routing Slip to MSC Director Robert R. Gilruth from Jack T. McClanahan, Chief, Apollo Mission Requirements, OMSF, received at MSC Dec. 12, 1966.



Astronaut Roger B. Chaffee prepares to enter Apollo spacecraft AS-204 in Kennedy Space Center's Manned Spacecraft Operations Building during October 1966 tests for the first manned Apollo mission. Phases of the mission—from countdown through liftoff, orbital insertion, and orbital exercises—were simulated in the altitude chamber.

Interested engineers watch as the LM ascent stage of TM-2 is readied for tests in the thermal vacuum chamber at Grumman's Bethpage, New York, plant in 1966.



1966

November

22

Perkin-Elmer Corp., Norwalk, Conn., and Chrysler Corp., Detroit, Mich., were authorized about \$250 000 each to continue studies of optical technology for NASA. The nine-month extension of research by the two companies was to evaluate optical experiments for possible future extended Apollo flights. The proposed experiments included control of optical telescope primary mirrors, telescope temperature control, telescope pointing, and laser propagation studies.

NASA News Release 66-300, Nov. 22, 1966.

25

MSC was requested by NASA Hq. to take the following actions:

1. Delete all experiments assigned to AS-205.
2. Assign experiment M005 (Bioassays Body Fluid, modified version) to AS-205/208.
3. Assign experiment M006 (Bone Demineralization) to AS-205/208.
4. Assign experiment M011 (Cytogenic Blood Studies) to AS-205/208.
5. Assign experiment M023 (Lower-Body Negative Pressure) to AS-205/208.
6. Redesignate experiments assigned to AS-207/208 to AS-205/208.

TWX, NASA Hq. to MSC (APO-CCB Directive No. 80), Nov. 25, 1966.

29

MSC's Director of Flight Crew Operations Donald K. Slayton said that the Block I flight crew nomenclature was suitable for the AS-204 mission, but that a more descriptive designation was desirable for Block II flights. Block I crewmen had been called command pilot, senior pilot, and pilot. Slayton proposed that for the Block II missions the following designations and positions be used: commander, left seat at launch with center seat optional for the remainder of the CSM mission, and left seat in the LM; CSM pilot, center seat at launch with left seat optional for remainder of mission; and LM pilot in the right seat of both the CSM and LM.

Memo, Slayton to distr., "Block II Apollo flight crew designation," Nov. 29, 1966.

December

5

In response to a request from Apollo Program Director Samuel C. Phillips on November 21, MSC reported its evaluation of Atlantic versus Pacific Ocean prime recovery areas for all Saturn V Apollo missions. MSC said that a change of recovery area to the Atlantic for AS-501 and AS-502 would cause some schedule slip and compromise of mission objectives and would not necessarily save recovery ship effort. For AS-503 and similar nonlunar missions, adjustments could be made to the mission profile to result in a prime recovery in the Atlantic area. Secondary support would be necessary in the Pacific, however. The report stressed that confining recovery to the Atlantic area for lunar missions would severely curtail the number of launch windows available.

Astronauts Donn F. Eisele, Walter M. Schirra, Jr., and R. Walter Cunningham, left to right, participate in 1966 Apollo egress training in a water tank in Building 260, Manned Spacecraft Center.

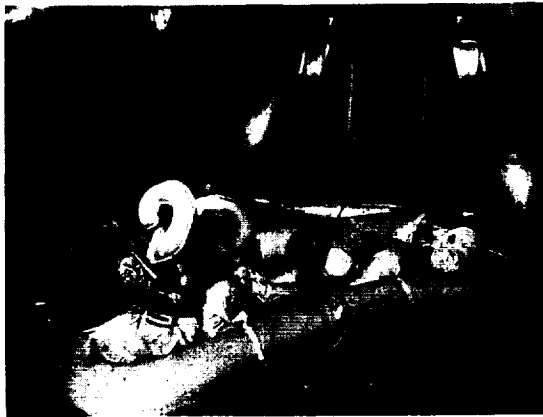

In a December 30 letter to MSC, KSC, and MSFC, the Apollo Program Director referred to the study and said it had been determined that plans for Pacific recovery for the AS-501 and AS-502 missions were justified.

1966
December

Ltrs., Christopher C. Kraft, Jr., MSC Director of Flight Operations, and Joseph F. Shea, Manager, ASPO, to NASA Hq., Attn: S. C. Phillips, "Atlantic Recovery," Dec. 5, 1966; Apollo Program Director, Office of Manned Space Flight, to MSC, KSC, and MSFC, "Atlantic Versus Pacific Recovery for Saturn V/Apollo Missions," Dec. 30, 1966.

During reassembly of LM Simulator (LMS) 1 at Houston, MSC personnel discovered that the digital-to-analog conversion equipment was not the unit used during the preship tests at Binghamton, N.Y.; it was apparent the unit had never been checked out, because at least five power-buss bars were missing. The unit had not checked out in the preship tests, and at the simulator readiness review test on October 14 Grumman had been authorized to replace the defective digital-to-analog core memory after the unit arrived at Houston. MSC questioned whether the delivery requirement of LMS-1 had been met and asked Grumman to explain why the switch was made without MSC knowledge and what steps Grumman expected to take to correct the situation.

5

TWX, MSC LM Project Officer to Grumman LM Program Manager, Dec. 5, 1966.

MSC Director of Flight Crew Operations Donald K. Slayton pointed out to ASPO Manager Joseph F. Shea that LM-to-CSM crew rescue was impossible. Slayton said (1) there was no way for the portable life support system and crewman to traverse from the LM front hatch to the CSM side hatch in zero-g docked operations, because there was no restraint system or tether attach points in the vicinity of the CSM hatch to permit the crewman to stabilize himself and work to open the hatch; and (2) there was no way to control the Apollo inner hatch (35-43 kilograms) to ensure that it would not inadvertently damage its seals, the spacecraft wiring, or the pressure

6

1966
December

bulkhead. Slayton added that several spacecraft changes, additional training hardware for valid thermal testing, zero-g simulator demonstration, and crew training effort would be required to permit extravehicular crew rescue from LM to CSM. Until this total rescue capability was implemented, manned LM to CSM operations would constitute an unnecessary risk for the flight crew.

Memo, Slayton to Shea, "Apollo EVA," Dec. 6, 1966.

- 6 Langley Research Center reported on its November study of visibility from the CSM during extraction of the LM from the S-IVB stage. The study had been made in support of the AS-207/208A mission, with assistance of MSC and North American Aviation personnel, to (1) determine if the CSM pilot could detect the signal indicating that the CSM had detached from the S-IVB, (2) determine if he could recognize a misalignment between the CSM/LM combination and the S-IVB during withdrawal, and (3) investigate simple aid techniques to make the pilot's task easier. Results indicated that (1) LM docking did not provide adequate indication of detachment of the LM from the S-IVB, but (2) in misalignment tests subjects could recognize errors as small as two to three degrees in yaw and five to seven centimeters in lateral translation except when the CSM/LM was yawed right and translated left relative to the S-IVB. The configuration of the model used prevented studying pitch, roll, or vertical translation misalignments.

Jack E. Pennington, "Results of Apollo Transposition Withdrawal Study," Langley Working Paper No. 335, Dec. 6, 1966.

- 7 In a memo to Apollo Program Director Samuel C. Phillips, Associate Administrator for Manned Space Flight George E. Mueller approved assignment of experiment S068, Lunar Meteoroid Detection, to the Apollo Program Office for implementation, provided adequate funding could be identified in the light of relative priority in the total science program. The experiment had been recommended by the Manned Space Flight Experiment Board (MSFEB) for a lunar mission. Also, as recommended by the MSFEB, the following experiments would be placed on the earliest possible manned space flight: S015 (Zero g, Single Human Cells); S017 (Trapped Particles Asymmetry); S018 (Micrometeorite Collection); and T004 (Frog Otolith Function).

Memo, Mueller to Phillips, "Experiment Assignments," Dec. 7, 1966.

- 7 Associate Administrator for Manned Space Flight George E. Mueller requested Leonard Reiffel, NASA Hq., "to be thinking about an appropriate name for the Lunar Receiving Laboratory—a descriptive kind of name rather than one that doesn't signify exactly what it is."

Note, Mueller to Reiffel (telecon), "Lunar Receiving Laboratory," Dec. 7, 1966.

The number one lunar landing research vehicle (LLRV) test vehicle was received at MSC December 13, 1966. Its first flight at Ellington Air Force Base following facility and vehicle checkout was expected about February 1, 1967, with crew training in the vehicle to start about February 20. A design review was held at Buffalo, N.Y., during the week of January 2, 1967, in connection with Bell Aerospace Company's contract for three lunar landing training vehicles (LLTVs) and associated equipment. No major design changes in the vehicle baseline configuration were requested. Crew training in helicopters and in the Lunar Landing Research Facility at Langley Research Center and the LLRV fixed base simulator was continuing.

1966

December

13

Memo, Director of Flight Crew Operations, MSC, to Deputy Director, MSC, "LLRV/TV Monthly Progress Report," Jan. 19, 1967.

MSC Director of Administration Wesley L. Hjernevik informed NASA Hq. that Frank Smith had told him on December 14 of his meeting with NASA management on Lunar Receiving Laboratory plans. Smith advised that MSC should take necessary actions immediately to begin operation of the LRL. MSC advised Headquarters that it planned to expand one of the two facility operation contracts at MSC to include the LRL and designate an LRL organization, staffed with qualified civil service personnel for immediate full-time operation.

15

TWX, Hjernevik to NASA Hq., "Lunar Receiving Laboratory Operations Plans," Dec. 15, 1966.

A meeting at NASA Hq. discussed plans for the Lunar Receiving Laboratory, noting that some problems were time-critical and needed immediate attention. Attending were Robert C. Seamans, Jr., Willis B. Shapley, George E. Mueller, Homer E. Newell, and Francis B. Smith, all of NASA Hq.; and Robert R. Gilruth, George M. Low, and Wesley L. Hjernevik of MSC.

19

The group agreed on the following interim actions:

1. Continued efforts to develop clearer definition of tasks that should be initiated to ensure the LRL would be ready for operation in time to handle returned lunar samples.
2. Creation of a task group at MSC to prepare for initial operation of the LRL. The task group would consist of MSC personnel plus a few new hires in critical skill areas.
3. Extension of the existing MSC support contract to provide minimum LRL technical and engineering support needed during the next few months.
4. Development of a clearer definition of the role and method of operation of the U.S. Public Health Officer to provide for more effective use of his recommendations for quarantine requirements.

1966
December

On December 21, Shapley informed Mueller and Newell that NASA Administrator James E. Webb and Deputy Administrator Seamans had approved the proposed actions.

Memos, Smith to Webb and Seamans, "December 19th meeting to discuss plans for the Lunar Receiving Laboratory," Dec. 19, 1966; Shapley to Mueller and Newell, "Lunar Receiving Laboratory," Dec. 21, 1966.

22 Lewis L. McNair, MSFC Chairman of the Flight Mechanics Panel, told Calvin H. Perrine, Jr., MSC, that the Guidance and Performance Sub-Panel had been unable to reach an agreement on venting the liquid-oxygen (LOX) tank of the Saturn V S-IVB stage during earth parking orbit. McNair pointed out that MSFC did not want a programmed LOX vent and that MSC did. He added that the issue must be resolved in order to finalize the AS-501 attitude maneuver and venting timeline.

Ltr., McNair to Perrine, Dec. 22, 1966.

22 In a memo to Donald K. Slayton, MSC Deputy Director George M. Low indicated that he understood George E. Mueller had stated in executive session of the Management Council on December 21 that he had decided a third lunar module simulator would not be required. Low said, "This implies that either the launch schedule will be relieved or missions will be so identical that trainer change-over time will be substantially reduced."

Memo, Low to Slayton, "Third LM Mission Simulator," Dec. 22, 1966.

22 NASA announced crew selection for the second and third manned Apollo missions. Prime crew for AS-205/208 would be James A. McDivitt, commander; David R. Scott, CM pilot; and Russell L. Schweickart, LM pilot. The backup crew would be Thomas P. Stafford, commander; John W. Young, CM pilot; and Eugene A. Cernan, LM pilot. The crew for AS-503, the first manned mission to be launched by a Saturn V, would be Frank Borman, commander; Michael Collins, CM pilot; and William A. Anders, LM pilot. The backup crew would be Charles Conrad, Jr., commander; Richard F. Gordon, Jr., CM pilot; and Clifton C. Williams, Jr., LM pilot.

NASA News Release 66-326, "NASA Names Crews for Apollo Flights," Dec. 22, 1966.

23 Handling and installation responsibilities for the LM descent stage scientific equipment (SEQ) were defined in a letter from MSC to Grumman Aircraft Engineering Corp. The descent stage SEQ was composed of three basic packages: (1) the Apollo Lunar Surface Experiments Package (ALSEP) compartment 1, which included the ALSEP central station and associated lunar surface experiments; (2) ALSEP compartment 2, composed of the radioisotope thermoelectric generator (RTG) and Apollo lunar surface drill (ALSD); and (3) the RTG fuel cask, thermal shield, mount and RTG fuel element. The following definition of responsibility for handling and installation had been derived:

1966
December

1. The SEQ would be installed in the LM descent stage while the LM was in the LM landing gear installation stand before LM-SLA mating, with the exception of the RTG fuel cask, thermal shield, mount and fuel element, and the ALSD.

2. The RTG fuel cask, thermal shield, mount and fuel element and the ALSD would be installed in the LM descent stage during prelaunch activities at the launch site.

3. Grumman would be responsible for SEQ installation with the exception of the RTG fuel element. The ALSEP contractor, Bendix Aerospace Systems Division, would provide the installation procedure and associated equipment. Bendix would also observe the installation operation and NASA would both observe and inspect it.

4. The Atomic Energy Commission (AEC) would be responsible for handling and installing the RTG fuel element. Bendix would provide procedures and associated equipment. Grumman and NASA would observe and inspect this operation. If for any reason the RTG fuel element was required to be removed during prelaunch operations, the AEC would be responsible for the activity. Removal procedures would be provided by Bendix. MSC requested that Grumman's planned LM activities at Kennedy Space Center reflect these points of definition.

Ltr., MSC to Grumman, "Contract NAS 9-1100, Handling and installation responsibilities for the LM descent stage Scientific Equipment (SEQ)," Dec. 23, 1966.

NASA Administrator James E. Webb approved establishment of a Science and Applications Directorate at MSC. The new directorate would plan and implement MSC programs in space science and its applications, act as a focal point for all MSC elements in these programs, and serve as the Center's point of contact with the scientific community. In addition to the Director's office, the new directorate would encompass an Advanced Systems Office, Lunar Surface Project Office, Space Physics Division, Applications Plans and Analysis Office, Applications Project Office, Lunar and Earth Sciences Division, and Test and Operations Office. In a letter on January 17, 1967, NASA Associate Administrator George E. Mueller told MSC Director Robert R. Gilruth the new Directorate was "another significant milestone in your effort to support the Agency and the scientific community in the exploration of space. . . ."

23

Organization Chart, MSC, Dec. 23, 1967; ltr., Mueller to Gilruth, Jan. 17, 1967.

Donald K. Slayton said there was some question about including extravehicular activity on the AS-503 mission, but he felt that, to make a maximum contribution to the lunar mission, one period of EVA should be included. Slayton pointed out that during the coast period (simulating lunar orbit) in the current flight plan the EVA opportunity appeared best between hour 90 and hour 100. Two primary propulsion system firings would have been accomplished and the descent stage of the LM would still be attached.

26

1966
December

Slayton specified that EVA should consist of a crewman exiting through the LM forward hatch and making a thorough orbital check of the LM before reentering through the same hatch. He said EVA on AS-503 would provide: (1) flight experience and confidence in LM environmental-control-system performance during cabin depressurization; (2) flight confidence in the Block II International Latex Corp. pressure garment assemblies; (3) orbital time-line approximation of cabin depressurization times, forward hatch operation, flight crew egress procedures, and LM entry following a simulated lunar EVA; (4) visual inspection and photography of LM landing gear for possible damage during withdrawal from the S-IVB stage; (5) external inspection and photography of the LM to record window and antenna contamination caused by SLA panel pyrotechnic deployment; (6) inspection and photography of descent engine skirt and adjacent areas for evidence of damage from two descent propulsion system firings; (7) inspection and photography of possible damage to the upper LM caused by the SM reaction control system during withdrawal; (8) possible additional data regarding EVA metabolic rates, etc., as applied to the Block II pressure garment assembly; and (9) additional orbital confidence in the portable life support system operational procedures.

Memo, Slayton to Technical Assistant for Apollo, "AS-503 Mission," Dec. 26, 1966.

30

Homer E. Newell, NASA Associate Administrator for Space Science and Applications, pointed out to MSC Director Robert R. Gilruth that during a program review he was made aware of difficulties in the development of the Apollo Lunar Surface Experiments Package. The problems cited were with the lunar surface magnetometer, suprathreshold ion detector, passive seismometer, and the central station transmitter receiver. Newell, who had been briefed on the problems by NASA Hq. ALSEP Program Manager, W. T. O'Bryant, said: "I felt they were serious enough to warrant giving you my views in regard to the importance of having the ALSEP with its planned complement of instruments aboard the first Apollo lunar landing mission. It is essential that basic magnetic measurements be made on the lunar surface, not only for their very important planetological implications, but also for the knowledge which will be gained of the lunar magnetosphere and atmosphere as the result of the combined measurements from the magnetometer, solar wind spectrometer, and suprathreshold ion detector."

MSC Deputy Director George M. Low, in a January 10 letter to Newell, thanked him and said he would discuss the problems with Newell more fully after receiving a complete review of the ALSEP program from Robert O. Piland.

Low wrote Newell on April 10, 1967, that there had been schedule slips in the program plan devised in March 1966—primarily slips associated with the lunar surface magnetometer, the suprathreshold ion detector, and the central station receiver and transmitter. "In each case, we have effected a programmatic workaround plan, the elements of which were presented to

Leonard Reiffel of OMSF and William O'Bryant of your staff on December 5, 1966, and in subsequent reviews of the subject with them as the planning and implementation progressed. . . ."

Ltrs., Newell to Robert R. Gilruth, Dec. 30, 1966; Low to Newell, Jan. 10, 1967; and Low to Newell, Apr. 10, 1967.

1966
December

B. Kaskey, Bellcomm, Inc., gave NASA Apollo Program Director Samuel C. Phillips three reasons why an AS-204 rescue of or rendezvous with a biosatellite would be impracticable: (1) The Block I spacecraft hatch was not designed to open and reseal in space, therefore no extravehicular activity could be planned for AS-204. (2) The launch window for 204 was five hours on each day, set by lighting available for launch aborts and normal recovery; rendezvous would reduce the launch window to minutes. (3) More than half of the reaction control system propellant was committed because of the requirement that deorbit be possible on every orbit without use of the service propulsion system. Phillips sent the information to ASPO Manager Joseph F. Shea at MSC.

Note, Kaskey to Phillips, NASA Hq., "Working Note," Jan. 3, 1967.

1967
January
3

An MSC meeting selected a Flight Operations Directorate position on basic factors of the first lunar landing mission phase and initiated a plan by which the Directorate would inform other organizations of the factors and the operational capabilities of combining them into alternate lunar surface mission plans.

Flight Operations Director Christopher C. Kraft, Jr., conducted the discussion, with Rodney G. Rose, Carl Kovitz, Morris V. Jenkins, William E. Platt, James E. Hannigan, Bruce H. Walton, and William L. Davidson participating.

The major factors (philosophy) identified at the meeting were:

- "The astronauts should be provided with an extravehicular (EVA) timeline framework and objectives and then be given real time control of their own activities. This approach should better accommodate the first lunar surface unknowns than if rigorous activity control were attempted from earth."

- "The LM should always be in a position to get back into lunar orbit in the minimum time. Specifically the merits and feasibility of maintaining the LM platform powered up and aligned should be evaluated. Any other LM systems requiring start up time after powering down should be identified."

- "The constraints affecting the minimum time required to turn around and launch after LM landing and the time line should be determined. This time was estimated to two CSM orbits. The effects of Manned Space Flight Network (MSFN) support should be considered."

- The first EVA should be allocated to LM post landing inspection, immediate lunar sample collection, lunar environment familiarization,

4

1967
January

photographic documentation, and astronaut exploration prerogatives. Any second EVA would include deployment of ALSEP (Apollo Lunar Surface Experiments Package) and a more systematic geological survey. Therefore, a mission nominally planned for only one EVA would not have to include an ALSEP in the payload. Any flight operations benefits resulting from deletion of the ALSEP weight and deployment operations (such as replacing weight with more fuel) must be determined."

Other less important factors were discussed and several action items were assigned: Rose would be responsible for successful implementation of plans resulting from the meeting. Hannigan would determine the LM, portable life support system, and ALSEP systems constraints and determine if the ALSEP weight allowance could be beneficially applied to LM consumables. The Operations Analysis Branch would investigate the MSFN support.

Memo, Chief, Operations Analysis Br., MSC, to Chief, Flight Control Div., MSC, "Operations viewpoint on first lunar surface mission plan," Jan. 5, 1967.

- 4 Charles A. Berry, MSC Director of Medical Research and Operations, proposed establishment of an MSC management program for control of hazardous spacecraft materials, to provide confidence for upcoming long-duration Apollo missions while simultaneously saving overall costs. Berry pointed out that no unified program for control of potentially toxic or flammable spacecraft materials existed and, in the past, individual Program Offices had established their own acceptance criteria for toxicological safety and fire hazards.

Memo, Berry to Deputy Director, MSC, "Management Program for Control of Hazardous Spacecraft Materials," Jan. 4, 1967.

- 4 Director of Flight Crew Operations Directorate (FCOD) Donald K. Slayton discussed the 2TV-1 (thermal vacuum test article) manned test program in a letter to the ASPO Manager. Pointing out that FCOD was providing an astronaut crew for the vacuum test program in support of the AS-258 mission, Slayton said the FCOD objective was to test and evaluate crew equipment, stowage, and system operations procedures planned for Block II flights. Slayton acknowledged that this objective was not identical with ASPO's requirement for thermal and vacuum verification of integrated system design, but felt that it was of equal importance and should be given equal priority in planning the test. To achieve the FCOD objective, he requested that specific conditions be met in spacecraft configuration, test planning, and test conduct.

Ltr., Slayton to Manager, ASPO, "2TV-1 Manned Test Program," Jan. 4, 1967.

- 10 Apollo Program Director Samuel C. Phillips told NASA Associate Administrator for Manned Space Flight George E. Mueller that studies had been completed on the use of "direct translunar injection" (launch directly into a trajectory to the moon) as a mode of operation for lunar landing missions. The principal advantages would be potential payload increases

1967
January

and elimination of the S-IVB stage restart requirement. The disadvantage was that there would be no usable launch windows for about half of each year and a reduced number of windows for the remainder of the year. Phillips was confident the launch vehicle would have adequate payload capability, since Saturn V performance continued to exceed spacecraft requirements. Confidence in successful S-IVB restarts was also high. For the lunar missions, therefore, direct launch was considered as a fall-back position and the effort was concentrating on the parking orbit mode.

Ltr., Phillips to Mueller, "Saturn V Direct Lunar Injection," Jan. 10, 1967.

The NASA Western Support Office, Santa Monica, Calif., reported two accidents at North American plants, with no personal injuries:

12

- Apollo CM 2S-1—being hoisted into a cradled position at North American Aviation's Space and Information Systems Division, Downey, Calif.—was dropped 1.8 meters onto a concrete floor Jan. 12. The first report was that the CM apparently suffered considerable damage.

- The S-II-5 interstage received possible structural damage when the protective metal roof covering of a handling fixture was struck during the swing opening of the six-story east door of Station 9 at the Seal Beach plant. The structural connections of the handling fixture to the interstage indicated damage. The S-II-5 interstage had been improperly parked within the swing opening of the east door.

Memo, William E. Lilly, NASA Hq., to George E. Mueller, NASA Hq., "Incident Reports: Damage to the Command Module 2S-1 and S-II-5 Interstage," Jan. 23, 1967.

Testing of CSM 012 at Downey, Calif., and KSC revealed numerous failures in the communications cable assembly caused by broken wiring, bent pins, and connector malfunctions. Certain design deficiencies in the system had been remedied by adding adapter cables in series with the cobra cable, but these additions had resulted in additional weak points in the system and in an unacceptably cumbersome cable assembly connected to crew members. For these reasons, Donald K. Slayton, Director of Flight Crew Operations, ruled the existing communications assembly unsafe for flight and requested that the biomedical tee adapter, cobra cable, sleep adapter, and noise eliminator be combined into one new cobra cable for CSM 012.

19

Memo, Slayton to Manager, ASPO, "Communications cables for Spacecraft 012," Jan. 18, 1967.

The Saturn 503 S-IVB stage exploded and was destroyed at the Douglas Sacramento, Calif., Test Facility at 4:25 p.m. PST during a countdown. The exercise had progressed to 10 seconds before simulated launch (about 8 minutes before S-IVB ignition) when the explosion occurred. Earlier that day the countdown had progressed to about 6 minutes past simulated launch when a problem with the GSE computer tape carrier head required a hold and a recycling in the countdown. No one was injured.

20

1967
January

A Douglas Aircraft Company investigating team under Jack Bromberg started operations the next morning, and an MSFC-appointed investigating board chaired by Kurt Debus, KSC, began operating three days after the accident.

TWX, MSFC to addressees, "Explosion of S-IVB-503 Stage," Jan. 23, 1967.

23

The Lunar Mission Planning Board held its first meeting at MSC. Present, in addition to Chairman Robert R. Gilruth, were Charles A. Berry, Maxime A. Faget, George M. Low, Robert O. Piland, Wesley L. Hjernevik, and acting secretary William E. Stoney, Jr., all of MSC. Principal subject of discussion was the photography obtained by *Lunar Orbiter I* and *Lunar Orbiter II* and application of this photography to Apollo site selection. The material was presented by John Eggleston and Owen Maynard, both of MSC. *Orbiter I* had obtained medium-resolution photography of sites on the southern half of the Apollo area of interest; *Orbiter II* had obtained both medium- and high-resolution photographs of sites toward the northern half of the area. Several action items were assigned, with progress to be reported at the next meeting, including a definition of requirements for a TV landing aid for the lunar module and a report on landing-site-selection restraints based on data available from *Lunar Orbiter I* and *II* only, and another on data from *Lunar Orbiter I, II, and III*.

Minutes of the Lunar Mission Planning Board, Jan. 23, 1967.

26

Apollo Program Director Samuel C. Phillips sent a message to the manned space flight Centers indicating that he wanted to supplement the findings of the S-IVB Accident Investigation Board with a review by the Crew Safety Panel of the possible impact on manned Apollo flights. He requested Crew Safety Panel members and any other necessary crew safety representatives to go to Sacramento, Calif., immediately, review the 20 January accident, and answer a number of questions:

1. What would have happened if a crew had been on board the space vehicle at the time of the accident?

2. What feasible methods were there within existing system capabilities to escape such an explosion? What other escape methods might be evolved beyond existing system capabilities?

3. How would the EDS (emergency detection system) have functioned if the accident had occurred on a manned flight? Should there be any changes to the EDS?

4. Should any changes be made to AS-204 to increase the probability of a safe escape?

Phillips said the panel's recommendations were needed by February 6 to help assess any impact on AS-204 and subsequent flights.

TWX, NASA Hq. to addressees, "S-IVB Stage Accident Investigation," Jan. 26, 1967.

Representatives of 62 nations signed the space law treaty, "Treaty on Principles Covering the Activities of the States in the Exploration and Use of Outer Space, Including the Moon and Other Celestial Bodies," at separate ceremonies in Washington, London, and Moscow. The treaty, which limited military activities in space, had been agreed upon by the U.S. and U.S.S.R. December 8, 1966, and unanimously approved by the United Nations General Assembly December 19. It was to become effective when ratified by the U.S., U.S.S.R., United Kingdom, and two other countries.

1967
January
27

Astronautics and Aeronautics, 1967 (NASA SP-4008, 1968), p. 23; and text of treaty.

Fire sweeping through command module 012 atop its Saturn IB launch vehicle at Launch Complex 34, KSC, took the lives of the three-man crew scheduled for the first manned Apollo space flight.

27

ASPO Manager Joseph F. Shea sent a flash report to NASA Hq.: "During a simulated countdown for mission AS-204 on January 27, 1967, an accident occurred in CM 012. This was a manned test with the prime astronaut crew on board. A fire occurred inside the command module resulting in the death of the three astronauts and as yet undetermined damage to the command and service modules." The launch had been scheduled for February 21.

The Director, Armed Forces Institute of Pathology in Washington, was alerted during late evening and informed that the accident had taken the lives of astronauts Virgil I. Grissom, Edward H. White II, and Roger B. Chaffee.

Later that evening a request for autopsy support was received and three pathologists and a medical photographer were sent to Cape Kennedy on an Air Force aircraft. Team members were Col. Edward H. Johnston, USA; Cdr. Charles J. Stahl, USN; Capt. Latimer E. Dunn, USAF; and T/Sgt Larry N. Hale, USAF.

The postmortem examinations began at 11 a.m. January 28 at the USAF Bioastronautic Operational Support Unit and were completed at 1 a.m. the following day.

TWX, Shea to NASA Hq., Attn: Apollo Program Director, Jan. 28, 1967; Append. D, "Panel 11," Report of Apollo 204 Review Board to the Administrator, National Aeronautics and Space Administration, Apr. 5, 1967, p. D-11-13.

The Apollo 204 Review Board was established by NASA's Deputy Administrator Robert C. Seamans, Jr., to investigate the Apollo 204 accident that had killed the 204 prime crew January 27. The Board would report to the NASA Administrator.

28

Appointed to the Board were:

- Floyd L. Thompson, Director Langley Research Center, Chairman.
- Frank Borman, astronaut, MSC.
- Maxime A. Faget, Director of Engineering and Development, MSC.



Effects of the flash fire on CM 012, photographed shortly after the fatal January 27, 1967, Apollo 204 accident: exterior of the command module, left, and interior, right.

1967
January

- E. Barton Geer, Associate Chief of Flight Vehicles and Systems Division, LaRC.
- George Jeffs, Chief Engineer, Apollo, North American Aviation, Inc.
- Frank A. Long, President's Science Advisory Committee member, Vice President for Research and Advanced Studies, Cornell University.
- Col. Charles F. Strang, USAF, Chief of Missiles and Space Safety Division, Air Force Inspector General, Norton Air Force Base, Calif.
- George C. White, Jr., Director, Reliability and Quality, Apollo Program Office, NASA Hq.
- John Williams, Director of Spacecraft Operations, KSC.

George Malley, Chief Counsel, LaRC, was named to serve as counsel to the Board.

The Board was told it could call upon any element of NASA for support, assistance, and information, and was instructed to:

- Review the circumstances surrounding the accident to establish the probable cause or causes and review the findings, corrective actions, and recommendations being developed by the program offices, field Centers, and contractors.
- Direct any further specific investigations necessary.
- Report its findings on the cause of the accident to the NASA Administrator as expeditiously as possible and release the information through the Office of Public Affairs.

- Consider the impact of the accident on all Apollo equipment preparation, testing, and flight operations.
- Consider all other factors related to the accident, including design procedures, organization, and management.
- Develop recommendations for corrective or other action based upon its findings and determinations.
- Document its findings, determinations, and recommendations and submit a final report to the Administrator, which would not be released without his approval.

1967

January

Memo for the Apollo 204 Review Board from Seamans, Jan. 28, 1967.

The Chairman and several members of the Apollo 204 Review Board assembled at KSC and met with NASA Deputy Administrator Robert C. Seamans, Jr., Apollo Program Director Samuel C. Phillips, and other personnel from NASA Hq., KSC, and MSC. The officials were given a quick appraisal of circumstances surrounding the January 27 accident and actions taken after the fire. The meeting was followed by an initial general session of the Board in the Mission Briefing Room, an area assigned to the Board to conduct its business. The Board adjourned to visit the scene of the accident, Launch Complex 34, and then reconvened to plan the review.

28

"Board Proceedings," *Report of Apollo 204 Review Board to the Administrator, National Aeronautics and Space Administration*, Apr. 5, 1967, p. 3-13.

Astronaut Frank Borman briefed the Apollo 204 Review Board after his inspection of the damaged command and service modules. A main purpose of the inspection was to verify the position of circuit breakers and switches. In other major activities that day, the Pyrotechnic Installation Building was assigned to the Board to display the debris and spacecraft components after removal from Launch Complex 34; the Board began interviewing witnesses; and the Board Chairman asked NASA Associate Administrator for Manned Space Flight George E. Mueller for assistance in obtaining flame propagation experts to assist the Board. Experts might be obtained from Lewis Research Center, the Bureau of Mines, and the Federal Aviation Agency. The Board Chairman established an ad hoc committee to organize task panels to make the accident investigation systematically. The committee was composed of John J. Williams, KSC; E. Barton Geer, LaRC; Charles W. Mathews, NASA, Hq.; John F. Yardley, McDonnell Aircraft Corp.; George Jeffs, North American Aviation, Inc.; and Charles F. Strang, USAF.

29

"Board Proceedings," p. 3-13.

Robert W. Van Dolah of the Bureau of Mines, I. Irving Pinkel of Lewis Research Center, and Thomas G. Horeff of the Federal Aviation Agency joined the Apollo 204 Review Board as consultants. Membership of the special ad hoc committee established January 29 to recommend special panels for the investigation was changed to Frank Borman and Maxime A.

30

1967
January

Faget, both of MSC; Charles W. Mathews, NASA Hq.; George Jeffs, North American Aviation, Inc.; John F. Yardley, McDonnell Aircraft Corp.; and John J. Williams, KSC, Chairman. Mathews outlined 19 recommended panels and the work objectives of each. A Board member was assigned to monitor each panel and to serve as a focal point through which the panels would report to the Board. Lt. Col. James W. Rawers (USAF) of the Range Safety Division Analysis Section presented an oral report on what Air Force Eastern Test Range personnel saw at the time of the accident. In other activities that day Faget introduced Alfred D. Mardel, MSC, who presented a briefing on data and sequence of events.

"Board Proceedings," p. 3-14.

31 Col. Charles F. Strang advised the Apollo 204 Review Board of an accident in an altitude chamber at Brooks Air Force Base, Tex., that morning. A flash fire had swept the oxygen-filled pressure chamber, killing Airman 2/C William F. Bartley, Jr., and Airman 3/C Richard G. Harmon. Col. Strang presented a short briefing on the circumstances and was asked by Chairman Floyd Thompson to provide follow-up information.

Lt. Col. William D. Baxter, Air Force Eastern Test Range representative to the Board, advised the group of existing Apollo spacecraft hazards, including:

- high-pressure oxygen bottles that might be pressurized to 335 newtons per square centimeter (485 pounds per square inch) and be subject to embrittlement;
- pyrotechnics on the service module; and
- a launch escape system with a 40-kilonewton (9000-pound-thrust) rocket motor.

An engineering review was made of these hazards and it was agreed that these items must be removed before any work could proceed.

In other actions on January 31, the Chairman of Panel 4, Disassembly Activities, briefed the Board on the Spacecraft Debris Removal Plan and the group approved the plan to the point of removing the astronauts' couches. In addition, Panel 19, Safety of Investigation Operations, was formed.

"Board Proceedings," pp. 3-14, 3-15; *Astronautics and Aeronautics, 1967* (NASA SP-4008, 1968), p. 29.

31 A TWX from NASA Headquarters to MSC, MSFC, and KSC ordered checkout and launch preparation of AS-501 to proceed as planned, except that the CM would not be pressurized in an oxygen environment pending further direction. If AS-501 support, facility, or work force should conflict with the activities of the AS-204 Review Board, the Board would be given priority.

TWX, Samuel C. Phillips to MSC, MSFC, and KSC, Jan. 31, 1967.

Funeral services were held for the Apollo crewmen who died in the January 27 spacecraft 012 (Apollo 204 mission) flash fire at Cape Kennedy. All three were buried with full military honors: Virgil I. Grissom (Lt. Col., USAF), and Roger B. Chafee (Lt. Cdr., USN), in Arlington, Va., National Cemetery; and Edward H. White II (Lt. Col., USAF), at West Point, N.Y. Memorial services had been held in Houston January 29 and 30.

Astronautics and Aeronautics, 1967 (NASA SP-4008, 1968), pp. 27, 29.

1967
January
31

MSC management directed contractors and other government agencies to stop all MSC-related manned testing in environments with high oxygen content. The message dispatched stated: "Until further notice, each addressee and his subcontractors is directed to cease all MSC related manned testing in an environment containing high oxygen concentrations. This restriction applies to all tests in chambers, enclosures, spacecraft, space suits, and includes any other procedure which may require any human activity within a concentrated oxygen environment. Unmanned qualification and development tests may continue in accordance with established plans as long as the contractor can assure that human safety is not jeopardized.

February
1

"Waivers for test continuation due to urgent programmatic schedules and commitments will be granted only by the Director of MSC. Each addressee should review all test procedures and use of equipment for unmanned testing using concentrated oxygen under pressure to assure that the tests are necessary and will be conducted safely.

"This message is precautionary in nature. It should not be construed to imply that any preliminary conclusions have been reached in the investigation of the recent Apollo accident.

"Unmanned buildup and preparations should proceed as planned, so that testing can be resumed when this restriction is lifted. . . ."

TWX, George M. Low, MSC, to addressees, Feb. 1, 1967.

The task of removing the launch escape system from AS-204 was delayed until retrorockets and other ordance devices could be removed from the launch vehicle and spacecraft.

1

Apollo 204 Review Board Chairman Floyd L. Thompson appointed a committee of two Board members and three consultants to coordinate panel activities and to bring to the attention of the Board the actions requiring specific approval. This Panel Coordinating Committee was required to present daily activity reports to the Board. Thompson announced that an executive session (Board members) would be held at 4 p.m. daily.

"Board Proceedings," p. 3-15.

1967
February
2

Command module 014 arrived from the North American Aviation plant in Downey, Calif., and was placed in the Pyrotechnic Installation Building at KSC. The module was to be used for training the technicians who would disassemble command module 012, the module in which the AS-204 fire had ignited. Before removal of any component from 012, the technicians were to perform similar tasks on 014, to become familiar with all actions required to remove any single component and minimize damage during removal. As a component was removed it was transported from the launch complex to the Pyrotechnic Installation Building. All equipment associated with the accident would also be placed in the PIB, including command module hardware and support equipment.

The Apollo 204 Review Board was informed that the most significant event in the investigation to date was the removal of the launch escape system from the command module, eliminating the greatest potential hazard to disassembly operations. With this task finished, members of the Fire Propagation Panel were expected to enter the command module the following day. Removal of the launch escape system also permitted extensive photographic coverage of the interior of the 012 command module.

Col. Charles F. Strang distributed copies of a status report of the January 31 accident at Brooks AFB, Tex., for the Board's information. NASA Deputy Administrator Robert C. Seamans attended the session.

"Board Proceedings," pp. 3-15, 3-16, 3-47.

2

MSC issued instructions to contractors and employees regarding release of information on any aspect of the AS-204 accident or investigation. The message said: "In accordance with the Apollo Failure Contingency Plan . . . and so this work may proceed rapidly and with complete integrity, all NASA and contractor employees are directed to refrain from discussing technical aspects of the accident outside of assigned working situations. This is meant to rule out accident discussion with other employees, family friends, neighbors and the like. All press information will be channeled through the Public Affairs Office.

TWX, MSC to distr., "MSC Posture on Apollo 204 Investigation," Feb. 2, 1967.

3

NASA Deputy Administrator Robert C. Seamans, Jr., reported to Administrator James E. Webb on progress of the Apollo 204 Review Board investigation of the January 27 spacecraft fire. Specific cause of the fire had not been determined from the preliminary review. Official death certificates for the three crew members listed cause of death as "asphyxiation due to smoke inhalation due to the fire." Webb released the report to Congress and the press.

Associate Administrator for Manned Space Flight George E. Mueller announced that the unmanned flights AS-206 (on uprated Saturn I) and AS-

501 and AS-502 (first and second Saturn V launches) would proceed as scheduled in 1967. Manned flights were postponed indefinitely.

1967
February

"Board Proceedings," p. 3-47; NASA News Releases 67-21 and 67-22, Feb. 3, 1967.

In memoranda for the Apollo 204 Review Board, NASA Deputy Administrator Seamans noted changes in the Board:

3

- Frank A. Long, President's Scientific Advisory Committee member and Vice President for Research and Advanced Studies at Cornell University, was no longer a member of the Board, effective February 1.
- Robert W. Van Dolah, Research Director for the Explosive Research Center of the Bureau of Mines, Department of the Interior, was appointed to the Board effective February 1.
- George Jeffs—Chief Engineer, Apollo, North American Aviation, Inc.—was consultant rather than member of the Board effective February 2.

Seamans also amplified and documented the oral instructions given to the Chairman January 28, 1967:

- The Chairman was to establish procedures for the organization and operation of the Board as he found most effective, and the procedures were to be part of the Board's records.
- Board members were to be appointed or removed by the Deputy Administrator after consultation with the Chairman as necessary for the Board's effective action.
- The Chairman could establish procedures to ensure the execution of his responsibility in his absence.
- The Chairman was to appoint or designate representatives, consultants, experts, liaison officers, observers, or other officials as required to support Board activities. He was to define their duties and responsibilities as part of the Board's records.
- The Chairman was to advise the Deputy Administrator periodically on the organization, procedures, and operations of the Board and its associated officials.
- The Chairman was to ensure that the counsel to the Board maintained memoranda records covering areas of possible litigation.

Memos, Seamans to Apollo 204 Review Board, Feb. 3, 1967.

The Apollo 204 Review Board Chairman requested that a document be written to establish procedures for entry into CM 012. Coordination of requirements and priorities would be controlled by the Panel Coordinating Committee, and entry into the CM by Frank Borman, MSC, or his delegated representative.

3

A display showing the sequence of events immediately preceding and following the accident was prepared from telemetry data and placed in the Mission Briefing Room. Time span of the display was from 6:30 p.m. to 6:33

1967

February

p.m., January 27. Significant information was included on communications, instrumentation, electrical power, environmental control, guidance and navigation, and stabilization and control.

Borman reported that the debris removal plan approved by the Board was progressing satisfactorily and that the next phase would use protective plywood covers for the couches to permit detailed examination of the command module interior.

Homer Carhart, Chief of Fuels Research, Chemistry Division, Naval Research Laboratory, was assigned to the Fire Propagation Panel. Board Chairman Floyd Thompson made the following appointments as Representatives of the Board: C. H. Bolender and Charles W. Mathews, both of NASA Hq.; Joseph F. Shea and G. Fred Kelly, MSC; Rocco Petrone, KSC; and William D. Baxter, Air Force Eastern Test Range.

"Board Proceedings," pp. 3-16, 3-17.

4

Apollo 204 Review Board Chairman Floyd L. Thompson established an Advisory Group to support the Board in its investigation. The group consisted of representatives, consultants, liaison officers, observers, and secretariat and would report to the Board Chairman.

Duties were defined as follows:

- Representative: represent a major element of NASA or other government agency having programs and activities associated with the Apollo Program.
- Consultant: serve as an adviser to the Review Board by providing opinions, information, and recommendations, as appropriate, based on his field of competence.
- Observer: acquire information relative to his area of expertise and normal responsibility.
- Secretariat: provide administrative, secretarial, clerical, and other supporting services to the Review Board.

The following were designated to the Advisory Group by Thompson:

Representatives: C. H. Bolender, NASA Hq., representing the Apollo Program Director; Charles W. Mathews, Director, Apollo Applications Program, NASA Hq.; Rocco A. Petrone, Director, Launch Operations, KSC; Joseph F. Shea, ASPO Manager, MSC; Lt. Col. William D. Baxter, USAF, Chief, Range Safety Office, Air Force Eastern Test Range; G. F. Kelly, Flight Medicine Branch, Center Medical Office, MSC.

Consultants: Frank A. Long, Vice President for Research and Advanced Studies, Cornell University; John Yardley, Technical Director, Astronautics Co., Division of McDonnell Co.; George W. Jeffs, Chief Engineer, Apollo Program, North American Aviation, Inc., or alternate R. L. Benner, Assistant Chief Engineer, Apollo Program, North American Aviation, Inc.; Irving Pinkel, Chief, Fluid Systems Research Division, Lewis Research

PART I: PREPARATION FOR FLIGHT AND THE ACCIDENT

Center; Thomas G. Horeff, Propulsion Program Manager, Engineering and Safety Division, Aircraft Development Service, Federal Aviation Agency; Homer Carhart, Chief, Fuels Branch, Chemistry Division, Naval Research Laboratory; and John S. Leak, Chief, Technical Services, Engineering Division, Bureau of Safety, Civil Aeronautics Board.

1967
February

Liaison Officer: Duncan Collins, Special Adviser, Secretary of the Air Force, Skylab Program.

Observers: All MSC astronauts; John D. Hodge, MSC; P. A. Butler and W. Dugan, both USAF; George E. Mueller and Samuel C. Phillips, both NASA Hq.; Kurt H. Debus, Paul C. Donnelly, John W. King, H. E. McCoy, R. E. Moser, W. P. Murphy, G. Merritt Preston, J. G. Shinkle, A. F. Siepert, and W. Williams, all of KSC.

Secretariat: Ernest Swieda, Executive Secretary.

Memo for Record, Floyd L. Thompson, "Establishment of Apollo 204 Review Board Advisory Group," Feb. 4, 1967.

Maxime Faget, MSC, distributed a draft report on the use of internal and external power on the command module for the information of the Apollo 204 Review Board. 4

Scott Simpkinson, MSC, Chairman of the Disassembly Activities Panel, presented the disassembly schedule. He expected removal of the couches from command module 012 by 5 a.m., followed by installation of the false floor by 12 noon on February 5. The false floor had previously been installed in command module 014 as a training exercise.

Frank Borman, MSC, was granted release of the impounded flight suits of the backup crew, for egress testing. The Board was to observe the test February 5.

"Board Proceedings," p. 3-17.

Lt. Col. William D. Baxter, Air Force Eastern Test Range, reported to the Apollo 204 Review Board that copies of statements by 90 witnesses of the January 27 fire had been transcribed. George Jeffs of North American Aviation announced that an NAA and AiResearch team had arrived to inspect the 012 command module and to propose further action on the environmental control unit and system. 6

Col. Charles F. Strang, USAF, said Board Chairman Floyd Thompson had asked that the "Life Sciences" portion of the final report include an analysis of the escape system, with redesign recommendations. The system fell within the purview of the Ground Emergency Procedures Review Panel, the In-Flight Fire Emergency Provisions Review Panel, the Design Review Panel, and the Medical Analysis Panel. G. Fred Kelly, MSC, was asked to coordinate findings.

"Board Proceedings," p. 3-18.

1967

February

7

The Senate Committee on Aeronautical and Space Sciences met in executive session to hear NASA testimony on the Apollo 204 fire. NASA Deputy Administrator Robert C. Seamans, Jr., said the cause of the accident had not yet been found. Corrective actions under study included choices of CM cabin and suit atmospheres, improved accessibility into and out of the CM cabin, and procedures to minimize the possibility of fires and to extinguish fires if they should occur.

Charges that the Apollo program was taking chances with lives in the effort to beat the U.S.S.R. to the moon were “completely unfounded; . . . before every one of our manned flights, as well as our ground test simulations, we have taken stock to be sure that there is nothing . . . undone or . . . done, that would in any way increase the risk to the astronauts.” The astronauts had been party to decisions and part of the review process to make sure this was true. Associate Administrator for Manned Space Flight George E. Mueller emphasized that the Apollo program had been “paced at a deliberate pace”; it was the longest research and development program the U.S. had ever undertaken.

MSC Chief of Center Medical Programs Charles A. Berry testified that the cabin atmosphere used in the Apollo program—100 percent oxygen at pressure of 3.5 newtons per square centimeter (5 pounds per square inch)—was based on extensive research over more than 10 years. The one-gas selection was based on tradeoffs among oxygen toxicity, hypoxia, spacecraft leakage, weight, and system reliability. And cabins had been purged with oxygen at some 10.3 newtons per square centimeter (15 pounds per square inch) during the prelaunch period for all manned launches since 1960 and all spacecraft vacuum chamber tests in Mercury, Gemini, and Apollo programs—primarily to prevent astronauts from getting the bends.

Three previous fires had occurred in the pure oxygen environment, but these had been in simulators and caused by test equipment and procedures that would not be used in spacecraft.

The three-door hatch, requiring 90 seconds to open, was used for the first time on CM 012, which had an inner pressure hull and an outer shell to carry the structural loads of reentry into the atmosphere on a return from the moon. Danger of a fast-opening escape hatch’s accidentally opening in space—as the Mercury program’s *Liberty Bell* hatch had opened after splashdown in July 1961—had to be considered. Research on cabin accessibility, ongoing before the 204 accident, was now intensified.

Senate Committee on Aeronautical and Space Sciences, *Apollo Accident: Hearing*, 90th Cong., 1st sess., pt. 1, Feb. 7, 1967.

7

Irving Pinkel, of Lewis Research Center and the Fire Propagation Panel, presented a preliminary report to the Apollo 204 Review Board. The report described the areas of the command module most damaged by the January 27 fire, the most probable fire paths, and the combustible materials in the

CM. The oxygen in the CM would permit burning of only 5.4 to 6.8 kilograms of material. Solid combustibles in the CM included plastics in the nylon, polyurethane, and silicone rubber classes. The liquid-coolant ethylene glycol could also become a fuel if it escaped from the closed coolant system.

The technical team from AiResearch and North American Aviation (under NASA supervision) completed inspection of the CM 012 spacecraft environmental control unit, preparatory to removal.

Panel 21 was formed for service module disposition. It would plan and execute SM activities and obtain Board approval for demating the command and service modules.

"Board Proceedings," p. 3-19.

Floyd L. Thompson, Chairman of the Apollo 204 Review Board, formally established 21 task panels to support the investigation. He appointed a Board member as monitor for each panel.

7

Duties of the panels were to:

- Perform all functions within their respective statements of work as approved by the appropriate Board monitors.
- Submit work plans through the Panel Coordination Committee to the Review Board for approval.
- Provide reports to the Review Board, when required, on the progress of work.
- Work with each other under the guidance of the Panel Coordination Committee.

Following are the names of the panels and the panel chairman and Board monitors assigned to each panel.

Apollo 204 Review Board Task Panels

<i>Panel No.</i>	<i>Panel Title</i>	<i>Panel Chairman</i>	<i>Board Monitor</i>
1	S/C and GSE Configuration	J. Goree, MSC	J. Williams, KSC
2	Test Environments	W. Hoyler, MSC	G. White, NASA Hq.
3	Sequence of Events	D. Arabian, MSC	M. Faget, MSC
4	Disassembly Activities	S. Simpkinson, MSC	F. Borman, MSC
5	Origin & Propagation of Fire	F. Bailey, MSC	R. Van Dolah
6	Historical Data	T. J. Adams, MSC	G. White, NASA Hq.
7	Test Procedures Review	D. Nichols, KSC	J. Williams, KSC
8	Materials Review	W. Bland, MSC	M. Faget, MSC
9	Design Reviews	R. Williams, MSC	G. White, NASA Hq.
10	Analysis of Fracture Areas	P. Glynn, MSC	B. Geer, LaRC

THE APOLLO SPACECRAFT: A CHRONOLOGY

1967 February	11	Medical Analysis	G. Kelly, MSC	F. Thompson, LaRC G. Malley, Counsel
	12	Witness Statements	N. Vaughn, MSC	G. Strang, USAF G. Malley, Counsel
	13	Ground Emergency Provisions	G. Page, KSC	F. Borman, MSC
	14	Security of Operations	C. Buckley, KSC	C. Strang, USAF
	15	Board Administrative Procedures	A. Griffin, KSC	B. Geer, LaRC
	16	Special Tests	G. Stoops, MSC	M. Faget, MSC
	17	Final Board Report	K. Hinchman, USAF	C. Strang, USAF
	18	Integration Analysis	A. Mardel, MSC	M. Faget, MSC
	19	Safety of Investigation Operations	J. Atkins, KSC	B. Geer, LaRC
	20	In-flight Fire Emergency Provisions Review	J. Lovell, MSC	F. Borman, MSC
	21	Service Module Disposition	W. Petynia, MSC	J. Williams, KSC

Memo for Record, Floyd L. Thompson, "Establishment of Apollo 204 Review Board Panels," Feb. 7, 1967.

- 7 MSC Director Robert R. Gilruth asked LaRC Director Floyd Thompson to conduct a study at Langley to familiarize flight crews with CM active docking and to explore problems in CM recontact with the LM and also LM withdrawal. MSC would provide astronaut and pilot-engineer support for the study. Apollo Block II missions called for CM active docking with the LM and withdrawal of the LM from the S-IVB stage, requiring development of optimum techniques and procedures to ensure crew safety and to minimize propellant utilization. LM withdrawal was a critical area because of clearances, marginal flight crew visibility, and mission constraints. Previous simulations at LaRC indicated the possibility of using the Rendezvous Docking Simulator.

Ltr., Gilruth to Thompson, Feb. 7, 1967.

- 8 MSC ASPO Manager Joseph Shea reviewed with George Jeffs of North American Aviation a deficiency in the mission control programmer (MCP) in spacecraft 017. Certain diodes—intended to prevent propagation of a single-point failure into redundant circuitry—had been omitted from the flight unit. The diodes appeared on MCP schematics but had been omitted from the hardware because of problems in ground testing. A fix appeared mandatory before flight. The MCP unit in spacecraft 020 would be similarly modified before final integrated tests, to confirm that the design change had not introduced other problems.

Shea requested a full explanation from North American "as to how the schematics and/or drawings being used by the responsible design review engineers did not reflect the as built conditions." A report detailing the loopholes in North American procedures that permitted such a condition and

PART I: PREPARATION FOR FLIGHT AND THE ACCIDENT

the corrective actions taken to prevent such incidents in the future was requested no later than March 1.

1967
February

Memo, Shea to distr., Feb. 8, 1967.

William W. Petynia, MSC, was given ASPO responsibility for use of the spacecraft 012 service module in nonflight support of the Apollo program when the Apollo 204 Review Board released the SM from further investigation. It was to be used in subsystem tests or tests of the complete module.

10

Memo, Petynia to Assistant Manager, ASPO, and Head, Apollo Support Office, "Disposition of the SC 012 Service Module," Feb. 10, 1967.

NASA Deputy Administrator Robert C. Seamans, Jr., and members of his staff were briefed at KSC on aspects of the Apollo 204 investigation: final report, fire propagation, photographic control, data integration, and medical analysis. The group also visited the Pyrotechnic Installation Building and other areas under the control of the Apollo 204 Review Board.

10

Board Chairman Floyd Thompson announced that the panel reports would be signed by the panel chairmen only and that the Board monitors assigned to the panels would be responsible for ensuring that minority views be given proper consideration. In the event that serious differences were not resolved, they were to be included in the panel reports for the Board's consideration.

"Board Proceedings," pp. 3-20, 3-51 through 3-53.

The Board of Inquiry into the January 20 S-IVB-503 explosion at the Douglas Sacramento Test Facility identified the probable cause as the failure of a pressure vessel made with titanium-alloy parent-metal fusion welded with commercially pure titanium. The combination, which was in violation of specifications, formed a titanium hydride intermetallic that induced embrittlement in the weld nugget, thus significantly degrading the capabilities of a weldment to withstand sustained pressure loads. The Board recommended pressure limitations for titanium-alloy pressure vessels.

10

TWX, NASA Hq. to MSC, KSC, and Grumman, Feb. 8, 1967; TWX NASA Hq. to MSFC, MSC, KSC, "Pressure Limitation on Titanium Alloy Pressure Vessels," Feb. 10, 1967; ltr., William Teir, MSFC, to MSC, Attn: Joseph F. Shea, "Titanium Pressure Vessels," Feb. 10, 1967.

Apollo 204 Review Board Chairman Floyd Thompson requested the NASA Office of Manned Space Flight, MSFC, KSC, and MSC to furnish a detailed description of their responsibilities, organizational relationships, and alignment in the Apollo program. Robert W. Van Dolah (Bureau of Mines), Chairman of the Origin and Propagation of Fire Panel, was asked to prepare a report on fire propagation by February 15 for submission to NASA Deputy Administrator Robert C. Seamans, Jr.

13

Specially built tables had been placed in the Pyrotechnic Installation Building to display items from CM 012 for inspection without handling.

1967
February

The Board also decided to ask that special studies of the spacesuits be made by the manufacturer and the MSC Crew Systems Division, to provide expert opinions on possible contributing factors to the fire and information for future spacesuit design.

"Board Proceedings," p. 3-21.

- 14** NASA Deputy Administrator Robert C. Seamans, Jr., gave Administrator James E. Webb a second interim report on the Apollo 204 Review Board investigation: "At this time there has been no determination as to the source of the ignition itself," but the fire apparently had varied considerably in intensity and direction and might have had more than one phase. All three crew spacesuits had been burned through, although extent of damage varied. Spacecraft disassembly was proceeding carefully, with detailed mapping and photography. Webb released the report to the press February 15.

"Board Proceedings," pp. 3-51 through 3-53; NASA News Release 67-28, Feb. 15, 1967.

- 14** Selected Apollo 204 Review Board members and panel chairmen were instructed to prepare an interim report on actions to date. The Board was to review the report February 19 for a briefing of NASA Deputy Administrator Seamans on February 22. Robert W. Van Dolah presented a report on findings by the Origin and Propagation of Fire Panel, for submission to Seamans.

Command module 012 was scheduled for removal from its launch vehicle February 17 because of satisfactory progress in removing systems from it.

"Board Proceedings," p. 3-21.

- 15** The Apollo 204 Review Board received a detailed briefing on the anomalies recorded before and during the CM 012 fire. The following anomalies were transmitted by the command module telemetry system to several recording stations: (1) communication difficulties, (2) high flow rate in oxygen system, (3) disruption of alternating current, (4) telemetry readings from a disconnected gas chromatograph connector, and (5) change in the gimbal angle of the inertial measurement unit, which might indicate movement in the command module. The Board asked additional testing and analysis.

"Board Proceedings," p. 3-22.

- 16** NASA Deputy Administrator Robert C. Seamans, Jr., informed Associate Administrator for Manned Space Flight George E. Mueller that, in view of the interim nature of schedule outlook for manned uprated Saturn I and Saturn V missions, he had decided to show these missions as "Under Study" in the Official NASA Flight Schedule for February 1967. As soon as firm approved dates for the missions were available the schedule would be updated. He said that all participants in the Apollo program should be advised that—except for unmanned missions 206, 501, and 502—official

agency schedule commitments had not been made and certainly could not be quoted until management assessments of the program had been completed and schedules approved by the Office of the Administrator.

1967
February

Memo, Seamans to Mueller, "Official NASA Apollo Schedules for Manned Missions," Feb. 16, 1967.

The Apollo 204 Review Board classified the materials in and around spacecraft 012 into three categories. Categories A and B were materials that had significant bearing on the results of the findings or were considered relevant to the investigation. Category C was essentially material not involved in the event, or only affected as a consequence of the event. Most of the Category C material would, at the time of its designation, be released to the program office for disposition and use within what might be termed normal program channels.

17

Memo, Joseph F. Shea, MSC, to distr., "Policy with respect to the use of material released from Apollo 204 Review Board jurisdiction," Feb. 16, 1967.

Command module 012 was separated from the service module and moved to the Pyrotechnic Installation Building for further disassembly and investigation.

17

"Board Proceedings," p. 3-22.

The Apollo 204 Review Board approved a plan to remove the spacecraft 012 service module from the launch vehicle on February 21. The service module was to be taken to the Manned Spacecraft Operations Building at KSC for detailed examination and testing. Board Chairman Floyd Thompson directed that a plan be developed to release Launch Complex 34 from impoundage and to return it to KSC for normal use after the SM was removed. Preparations were being made to remove the aft heatshield from the command module to permit inspection of the CM floor from the lower side.

20

"Board Proceedings," p. 3-23.

Kenneth S. Kleinknecht was designated Chairman of the CSM Configuration Control Panel in the Apollo Spacecraft Program Office, MSC. He would have authority to approve CSM changes within the limits outlined in the ASPO Configuration Management Plan.

20

Memo, Manager, ASPO, to distr., "CSM Configuration Control Panel Chairman," Feb. 20, 1967.

Apollo program officials were briefed on significant information, tentative findings, and preliminary recommendations developed by the Apollo 204 Review Board. Those present included George E. Mueller, Samuel C. Phillips, C. H. Bolender, Frank A. Bogart, and Julian B. Bowman, all of NASA Hq.; Robert R. Gilruth, George M. Low, and Christopher C. Kraft, Jr., all of MSC; Kurt H. Debus, KSC; and Wernher von Braun, MSFC.

21

1967
February

Ashmun Brown, Office of Chief Counsel, KSC, was assigned to assist the counsel to the Board.

"Board Proceedings," pp. 3-23, 3-24.

22

A formal briefing on progress of the Apollo 204 Review Board was presented to NASA Deputy Administrator Robert C. Seamans, Jr., David Williamson of Seamans' staff, and Charles A. Berry, Joseph F. Shea, Donald K. Slayton, and Walter M. Schirra, Jr., all of MSC.

In a general session of the Board, Chairman Floyd Thompson stated that 1500 persons were giving direct support to the accident investigation. This number, considered to be conservative, consisted of 600 persons from NASA, Air Force, Navy, Department of the Interior and other government agencies, and 900 from industry and universities.

"Board Proceedings," p. 3-24.

23

Apollo Program officials, headed by NASA Associate Administrator for Manned Space Flight Mueller, briefed Deputy Administrator Seamans, Apollo 204 Review Board members, and those present at the February 22 briefing. The presentation included a status report on the Apollo program, on special tests being conducted and planned as a result of the January 27 fire, and on proposed actions on the tentative Review Board findings.

Board Chairman Floyd Thompson, LaRC; Robert Van Dolah, Bureau of Mines; and Frank Borman, MSC, accompanied Seamans to Washington the following day, to brief Administrator James E. Webb on the tentative findings and preliminary recommendations of the Board (see February 25).

The spacecraft-lunar module adapter (SLA) was removed from the launch vehicle and moved to the Manned Spacecraft Operations Building for examination.

"Board Proceedings," pp. 3-24, 3-25, 3-55 through 3-59.

23

William A. Lee was redesignated from Assistant Program Manager, Apollo Spacecraft Program Office, to Manager for the LM, ASPO, at MSC. Lee would be responsible for the management of the lunar module program, including MSC relations with Grumman and other supporting industrial concerns. Lee would report to ASPO Manager Joseph F. Shea and would assist him in the following areas:

1. Directing the design, development, and fabrication program contracted by NASA with Grumman.
2. Directing and planning detailed system engineering and system integration functions for the project, including review of engineering design work and system engineering studies by the contractor.
3. Development of the program of ground and flight tests at White Sands Missile Range, MSC, and KSC.

1967
February

4. Monitoring contractors' operations to ensure adherence to specifications, to identify and solve problems which might impede the development of systems or subsystems.

5. Directing subordinate functional chiefs on all vehicle problems in the project and resolving or securing resolution of major technical, flight, and program problems.

6. Chairing the Change Control Panel for LM.

Manned Spacecraft Center Announcement, 67-34, "Manager for Lunar Module Apollo Spacecraft Program Office," Feb. 23, 1967.

NASA Administrator James E. Webb released a statement and Deputy Administrator Robert C. Seamans' third interim report on the Apollo 204 Review Board investigation, including tentative findings and preliminary recommendations.

25

Webb said the risk of fire in the 012 command module had been greater than recognized when procedures were established for the January 27 manned test that had ended in a fatal flash fire. Successful Mercury and Gemini flight experience with pure oxygen atmospheres and the difficulty of keeping dropped items out of complex wiring and equipment had led to placing Velcro pads, covers over wire bundles, and nylon netting in the CM cabin. Although mostly of low combustion material, they were not arranged to provide barriers to the spread of fire. Soldered joints also had melted, and leaked oxygen and fluids had contributed to the fire. The capsule rupture caused flames to rush over and around astronaut couches to the break, preventing the crew from opening the hatch. And the environmental control unit would require careful examination and possible redesign.

Seamans reported an electrical malfunction was the most likely source of ignition of the fire, which apparently had three distinct phases. Principal preliminary recommendations of the Review Board were:

- Combustible material in the CM should be replaced whenever possible by nonflammable materials, all nonmetallic materials should be arranged to maintain fire breaks, oxygen or combustible liquid systems should be made fire resistant, and full flammability tests should be conducted with a mockup of each new configuration.

- A more rapidly and more easily operated CM hatch should be designed.

- On-the-pad emergency procedures should be revised to recognize the possibility of cabin fire.

The Board also suggested some subsystems and procedures could be improved for safety. It did not recommend that cabin atmosphere for operations in space be changed from pure oxygen at pressure of 3.5 newtons per square centimeter (5 pounds per square inch), but did recommend that tradeoffs between one-gas and two-gas atmospheres be reevaluated and that pressurized oxygen no longer be used in prelaunch operations.

"Board Proceedings," pp. 3-55 through 3-59; NASA News Release 67-38, Feb. 25, 1967.

1967

February

27

NASA officials testified in an open hearing of the Senate Committee on Aeronautical and Space Sciences on the Apollo 204 fire. MSC Chief of Center Medical Programs Charles A. Berry reported that the cause of the three astronauts' deaths could be refined to asphyxiation from inhalation of carbon monoxide, bringing unconsciousness in seconds and death rapidly thereafter. The astronauts were believed to have become unconscious 18 to 20 seconds after the fire began.

Associate Administrator for Manned Space Flight George E. Mueller said NASA was introducing a three-pronged effort to prevent fire in the future: it would continue to minimize the possibility of ignition but would recognize the possibility would always exist, would seek to eliminate the chance of propagation if a fire began, and would seek to minimize consequences of a fire to the crew. Newly developed nonflammable materials would be used wherever possible and would be arranged to maintain fire breaks. Systems would be made more fire- and heat-resistant. The new CM cabin would be verified by full boilerplate flame tests. Design work was under way on a new unified hatch—a single integrated hatch to replace the double hatch and permit emergency exit in two seconds, yet remain safely sealed in flight. Emergency procedures were being revised. Spacecraft system design and qualification were being thoroughly reviewed. Alternative cabin atmospheres for checkout and launch were being studied, but during flight itself pure oxygen at 3.5-newtons-per-square-centimeter (5-pounds-per-square-inch) pressure still appeared safest for crews, with best balance among fire hazard, system reliability, and physiological risks.

First Apollo Block II spacecraft—CSM 101, the next in line at North American Aviation—was to incorporate all changes determined necessary by the investigation.

Senate Committee on Aeronautical and Space Sciences, *Apollo Accident: Hearings*, 90th Cong., 1st sess., pt. 2, Feb. 27, 1967.

March

1

Apollo 204 Review Board Chairman Floyd Thompson announced that the NASA Deputy Administrator had signed a memorandum February 27 designating the Director, Langley Research Center, custodian of the Review Board material.

Maxime Faget, MSC, presented a plan for screening equipment removed from the CM. The plan was intended to reduce the effort and time required to investigate and analyze the equipment. The Board agreed that the Panel Coordination Committee would establish an ad hoc committee to perform the screening.

"Board Proceedings," p. 3-25.

2

MSC ASPO reported to NASA Hq. that, because of many wiring discrepancies found in Apollo spacecraft 017, a more thorough inspection was required, with 12 main display control panels to be removed and wiring

visually inspected for cuts, chafing, improper crimping, etc. The inspection, to begin March 2, was expected to take three or four days.

1967

March

The two crates containing the mission control programmer (MCP) for CSM 017 had been delivered to Orlando, Fla., February 26 with extensive damage. Damage indicated that one crate might have been dropped upside down; its internal suspension system was designed for right-side-up shock absorption. The second crate contained holes that might have been caused by a fork lift. The MCP was returned to Autonetics Division of North American Aviation for inspection; barring dynamic programmer problems, the equipment was expected to be returned to KSC by March 7. The crates bore no markings such as "This Side Up" or "Handle with Care."

Ltr., Assistant Manager, ASPO to NASA Hq., Attn: Samuel C. Phillips, "ASPO Weekly Project Status Report to MSF," March 2, 1967.

The Apollo 204 Review Board decided to classify all material from command module 012 as Category A or Category B items. Category A would include all items that were damaged or identified as suspect or associated with anomalies. Category B would include items that appeared to be absolved of association with the January 27 accident; these would be available to the Apollo Program Office for use in nondestructive tests, but the Board would require copies of all test reports. Frank Borman, MSC, announced that disassembly of the command module was scheduled for completion by March 10.

3

"Board Proceedings," p. 3-26.

Although the final recommendations of the Apollo 204 Review Board were not yet in hand, MSC Deputy Director George M. Low believed the program "should start preparing a set of criteria which must be followed before we can resume testing in an oxygen environment. These criteria can then be used either to allow us to sign waivers on our testing embargo, or to go forward with additional messages, permitting testing, provided our criteria are met." He said the criteria would probably differ for: (1) spacesuit testing, (2) testing in oxygen chambers, and (3) testing within spacecraft. "They would probably include such things as the exact environment within and outside the enclosure; the type of flammable material; safety precautions and procedures; and emergency procedures."

6

Memo, Low, MSC, to A. C. Bond, MSC, "Resumption of testing in an oxygen environment," March 6, 1967.

During a House Committee on Science and Astronautics hearing on NASA's FY 1968 authorization, NASA Administrator James E. Webb replied to questions by Congressmen John W. Wydler, Edward J. Gurney, and Emilio Q. Daddario about the impact of the Apollo 204 accident on schedules for accomplishing the lunar landing. Webb said:

7

1967

March

“As the man asked by President Kennedy and later by President Johnson to take the responsibility for this program, I have provided to you information showing the need for the 12 Saturn I-B’s and the 15 Saturn V vehicles, and have stated that if we could get the kind of developed performance out of these vehicles on the early flights that would give us confidence that we could turn some of the earlier flights loose to go to the Moon, we might do this earlier than later.

“I have stated that if it took all 15 Saturn V’s to complete the mission, it would not be done in this decade.

“Now the charts that you have seen this morning show that we are going to exercise the Apollo Command Module, the Service Module, and the Lunar Excursion Module around the Earth with the Saturn I-B vehicle, and that we will be doing this in this year and next year.

“It also shows that if we can fully test out and be very sure of the performance of the Saturn V vehicle with all of the equipment that is riding on it, we would put men into the third or more likely the fourth vehicle. Now that vehicle will have on it everything necessary to go to the Moon. But I cannot tell you today that it will be turned loose to the Moon even if everything on it is perfect, because my judgment as Administrator is that we are going to exercise this equipment around the Earth more than that before we start for the Moon.

“On the other hand, if everything is working perfectly, it would be logical to start; whether we get halfway and come back, I don’t know. But many people who are very optimistic have assumed that because you plan now before any large rocket has ever flown to put all the equipment on the fourth flight that you are going to completely succeed and therefore you will in fact turn that loose to the Moon next year.

“I do not believe so, and have so stated time and time again, publicly and to this committee.

“I would like to say one other thing. In order to mobilize this effort to make everything fit together, we have prepared schedules that have target dates on them, and the target date for flying the fourth Saturn V has been in the summer or early fall of 1968. So many people have said, ‘What is the earliest time you could go, isn’t that really your target?’ Well, obviously we want to go as soon as we can, and obviously if everything worked perfectly, this vehicle would be fully equipped to go. But my own judgment is that if we get this done by the end of 1969, we will be very, very fortunate; that the chance that we will do so, the odds that we will do so, the possibility of doing all the work necessary is less this year than it was last. And I testified at this table last year that it was less at that time than it had been the previous year. So we have had in my judgment some accumulation of difficulties which make the problem of doing it in this decade more difficult. But it is still not

out of the picture, and shall I say, not impossible, although almost impossible to think of a 1968 date.”

1967

March

House Committee on Science and Astronautics, *1968 NASA Authorization: Hearings*, pt. 1, 90th Cong., 1st sess., Feb. 28, March 1, 2, 7, 8, 9, 1967, pp. 186-87.

The aft heatshield was removed from CM 012. A close inspection disclosed that the rupture in the floor extended about two-thirds of the circumference, a rupture much greater than originally estimated.

7

“Board Proceedings,” p. 3-27.

Maxime A. Faget, MSC, presented the Apollo 204 Review Board a follow-up report on analysis of the arc indication on the lower-equipment-bay junction-box cover plate. The plate had been delivered to the KSC Material Analysis Laboratory and, in addition to the analysis of the arc indication, molten material found on the bottom of the plate would also be analyzed.

8

“Board Proceedings,” p. 3-27.

NASA Associate Administrator for Manned Space Flight George E. Mueller stated that the February completion of MSFC studies of the Saturn V launch vehicle’s payload and structural capability would permit an official revision of the payload from 43 100 kilograms to 44 500 kilograms; the CM weight would be revised from 5000 to 5400 kilograms; and the LM from 13 600 to 14 500.

8

Memo, Mueller to Seamans, “Weights of Major Apollo Flight Systems for Official Quotation,” March 8, 1967.

J. Thomas Markley, Assistant Manager of ASPO, pointed out that within a few weeks MSC would face sustaining engineering problems. Many subcontractors not affected by the January 27 Apollo 204 accident would be phasing out of work; also many of them would be out of business long before the major flight program would start. He asked, “How do we now retain that talent for some necessary period of time?” He requested that Systems Engineering define requirements for retaining the technical capability for the overall systems, as well as the unique subsystem capability potentials that might need to be retained. He requested the package be prepared for his review by April 3.

10

Memo, Markley to John B. Lee, R. W. Williams, and J. G. McClintock (all of MSC), “Sustaining Engineering,” March 10, 1967.

The Apollo 204 Review Board met with chairmen of Panels 12, 16, 19, and 20 (see February 7 and following entries) for critical review of their draft final reports. The reports were accepted subject to editorial corrections. The Witness Statements Panel (Panel 12) task had been to collect all data from witnesses of the 204 accident, including both eyewitnesses and console monitors, and to prepare the data for publication as appendix to the formal

13

1967

March

report. The panel also was to analyze the sequence of events and summarize any testimony that was contradictory to the main data.

Eyewitnesses and television and audio monitors from 18 agencies and contractors had been queried. Responses from 590 persons totaled 572 written and 40 recorded statements—adding up to 612 statements obtained (some persons submitted more than one statement or were interviewed twice).

The sequence of events, as reconstructed from witness statements, follows:

*Between 6:31:00 and
6:31:15 p.m. EST Jan. 27, 1967*

Witnesses in launch vehicle aft interstage, Level A-2:	Felt two definite rocking or shaking movements of vehicle before "Fire" report. Unlike vibrations experienced in past from wind, engine gimballing, or equipment input.
--	---

Witnesses on Levels A-7 and A-8:	Heard "Fire" or "Fire in Cockpit" transmissions. Heard muffled explosion, then two loud whooshes of escaping gas (or explosive releases). Observed flames jet from around edge of command module and under White Room.
----------------------------------	--

TV monitors:	Heard "Fire" or "Fire in Cockpit" transmissions. Observed astronaut helmet, back, and arm movements; increase of light in spacecraft window; and tonguelike flame pattern within spacecraft. Observed flame progressing from lower left corner of window to upper right; then spreading flame filled window, burning around hatch openings, lower portion of command module, and cables.
--------------	--

*Between 6:31:15 and
6:33 p.m. EST*

Witnesses on Levels A-7 and A-8:	Repeated attempts to penetrate White Room for egress action. Fought fires on CM, SM, and in White Room area.
----------------------------------	--

TV monitors:	Observed smoke and fire on Level A-8. Progressive reduction of visibility
--------------	---

1967

March

*Between 6:33 and
6:37 p.m. EST*

of spacecraft hatch on TV monitor because of increasing smoke.

Repeated attempts to remove hatch and reach crew. Spacecraft boost protective cover removed by North American personnel J. D. Gleaves and D. O. Babbitt. Spacecraft outer hatch removed by North American personnel J. W. Hawkins, L. D. Reece, and S. B. Clemmons. Spacecraft inner hatch opened and pushed down inside by Hawkins, Reece, and Clemmons, approximately 6:36:30 p.m. EST. No visual inspection of spacecraft interior possible because of heat and smoke. No signs of life.

*Between 6:37 and
6:45 p.m. EST*

Remains of fires extinguished. Fire and medical support arrived. Fireman J. A. Burch, Jr., and North American technician W. M. Medcalf removed spacecraft inner hatch from spacecraft. Examination of crew and verification of condition.

*Between 6:45 p.m. EST Jan. 27
and 2:00 a.m. EST Jan. 28*

Service structure cleared. Photographs taken. Crew removed. Complex and area under secure conditions. Personnel from Washington and Houston arrived and assumed control.

In its final report to the Review Board the panel indicated it believed that all persons with pertinent information regarding the accident had been queried.

"Board Proceedings" and Append. D, "Panels 12 thru 17," Report of Apollo 204 Review Board to the Administrator, National Aeronautics and Space Administration, April 5, 1967, pp. 3-28, 3-29, and D-12-3 through D-12-12.

The report of the Apollo 204 Review Board's In-flight Fire Emergency Provisions Review Panel (No. 20) listed seven findings and accompanying determinations. The panel had been charged with reviewing the adequacy of planned inflight fire emergency procedures and other provisions, as well as determining that emergency procedures existed for all appropriate activities. Among findings and determinations were:

13

1967

March

- *Finding*—An inflight fire procedure was published and available to the Apollo 204 crew. The procedure was analyzed with reference to the Apollo 204 CM 012 configuration.

- *Determination*—Existing inflight fire procedures were deficient in the following areas:

- (a) Turning off the cabin fans should be the first item of the procedural check list. This might help prevent the spread of fire by minimizing cabin air currents.

- (b) The procedure should have specified the length of time to keep the cabin depressurized to ensure the fire had been extinguished and that all materials had cooled to below their ignition temperature.

- *Finding*—The command module depressurization time to drop from 3.5 to 0.4 newtons per square centimeter (from 5 to 0.5 pounds per square inch) could vary from 1 minute 45 seconds to 3 minutes 20 seconds, according to the flight-phase ambient temperature.

- *Determination*—The depressurization time was too slow to combat a cabin fire effectively

"Board Proceedings" and Append. D, "Panels 19 thru 21," *Report of Apollo 204 Review Board*, pp. 3-29 and D-20-3 through D-20-9.

13

The Special Tests Panel (No. 16) report to the Apollo 204 Review Board summarized activities from January 31 to February 23, when it had been merged with Panel 18. Panel 16 had been established to coordinate tests by other groups into an overall coordinated test plan. For example, flammability would be tested at several locations and the panel would ensure coordination. Major tests such as mockups of actual configurations and boilerplate destructive combustion tests would be considered by the panel. (See March 31 for Panel 18 report).

"Board Proceedings" and Append. D, "Panels 12 thru 17," *Report of Apollo 204 Review Board*, pp. 3-29 and D-16-3.

14

The Service Module Disposition Panel (No. 21) report accepted by the Apollo 204 Review Board said test results had failed to show any SM anomalies due to SM systems and there was no indication that SM systems were responsible for initiating the January 27 fire.

Panel 21 had been charged with planning and executing SM activities in the Apollo 204 investigation, beginning at the time the Board approved the command module demate. The task was carried out chiefly by Apollo line organizational elements in accordance with a plan approved by the Board and identifying documentation and control requirements.

The panel's major activities had been:

- Demating the service module and service module-lunar module adapter from the launch vehicle and moving them to the Manned Spacecraft Operations Building.

- Inspecting the exterior and interior areas of the service module.
- Making detailed system tests of all service module systems that were mechanically or electrically connected to the command module at the time of the accident.

1967
March

"Board Proceedings," and Append. D, "Panels 19 thru 21," *Report of Apollo 204 Review Board*, pp. 3-29 and D-21-3 through D-21-6.

Apollo Program Director Samuel C. Phillips appointed a team to make a special audit of quality control and inspection. The audit would encompass Apollo spacecraft operations at Downey, Calif., KSC, and elsewhere as required and would consider both contractor and government activities to determine if problems or deficiencies existed and recommend corrective action. The team was to use to the maximum extent the results of quality and inspection audit activities already under way at MSC and KSC.

14

Specifically, the team was to (1) review inspection standards for compatibility with Apollo program requirements, the degree to which these standards had been reduced to effective instructions and criteria for use by individual inspectors, and consistency between sites; (2) evaluate at each activity the program for selection, training, and evaluation of quality control and inspection personnel; (3) evaluate the adequacy of follow-up, closeout action and treatment by management of reported discrepancies in quality reports, failure reports, and program action requests; (4) evaluate the effectiveness of materials and parts control in ensuring that all materials and parts in end items as well as those used in processing and testing were in accordance with drawings and specifications; and (5) evaluate methods used to ensure quality of product from vendors and subcontractors.

Phillips named Rod Middleton of NASA OMSF to chair the team. Other members were Willis J. Willoughby, OMSF; Martin L. Raines, White Sands Test Facility; John Berkebile, MSFC; John D. Dickenson, KSC; and Jeff Adams and Robert Blount, MSC. Phillips requested a report by March 31.

TWX, NASA Hq. to MSC, MSFC, KSC, and White Sands Test Facility, March 14, 1967.

CSM 017 was in hold because of numerous discrepancies found in the spacecraft (see also March 2). Of 1368 "squawks" concerning exposed wiring, 482 had been resolved by March 14. Spacecraft mechanical mating with the launch vehicle was projected for April 29 (but see also April 10 and June 20).

15

Ltr., Assistant Manager, ASPO, MSC, to NASA Hq., Attn: Samuel C. Phillips, "Weekly Project Status Report to MSF," March 15, 1967.

MSC informed Kennedy Space Center that, on release of the 012 service module from further investigation, the MSC Apollo Spacecraft Program Office would use it for program support. ASPO was establishing tests and

15

1967

March

test locations and asked KSC to deactivate SM systems and store the SM in a remote area for up to four weeks.

TWX, J. Thomas Markley, Assistant Manager ASPO, MSC, to Eugene McCoy, KSC, March 15, 1967.

15

MSC Director of Flight Crew Operations Donald K. Slayton requested that a rendezvous of the CSM with its launch vehicle S-IVB stage be a primary objective of the Apollo 2 mission [i.e., Apollo 7; Slayton apparently wanted to acknowledge only scheduled manned flights in the sequentially numbered Apollo missions]. He stated that the exercise could be conducted after the third darkness without interference with normal spacecraft checkout. "We believe a rendezvous with the booster on the first manned Apollo mission would be compatible with developing lunar mission capability at the earliest opportunity and request its incorporation into the primary mission objective." A memorandum from Flight Operations Director Christopher C. Kraft, Jr., on April 18 recognized "the need for CSM active rendezvous early in the Apollo flight program, but recommends that rendezvous not be considered during the first day of the Apollo 7 [the official flight designation for the first manned flight] mission. . . ." and presented four reasons: (1) the initial manned flight should concentrate on systems, (2) there was a reasonable probability that system problems or other unknowns would cause cancellation of rendezvous activity, (3) the early part of a first-of-a-kind mission was open-ended, and (4) crew and flight control experience was limited in updating and preparing for contingency deorbit, which would be further complicated by maneuvering effects on the orbit. The Flight Operations Directorate recommended "that any rendezvous activity be scheduled after a minimum of one day of orbital flight, and that it be limited to a simple equiperiod exercise with a target carried into orbit by the spacecraft."

Memos, Director of Flight Crew Operations to Manager, ASPO, "Rendezvous exercise for the Apollo 2 Mission," March 15, 1967; Director of Flight Operations to Manager, ASPO, and Director of Flight Crew Operations, "Proposed rendezvous exercise for the Apollo 7 mission," April 18, 1967.

16

LeRoy E. Day, NASA OMSF, suggested to Apollo Program Director Samuel C. Phillips that, "if we are going to achieve a tight schedule of redesign and test activity as a result of AS-204 [accident], a number of changes in our mode of operation may be necessary." He recommended a concerted effort to systematize and discipline the scheduled reporting system between OMSF, ASPO, and the contractor. Day further suggested monthly "Black Saturday Reviews" by ASPO with OMSF participation. The reviews would be detailed and cover all spacecraft activities and should be given against the same set of baselines as all program reviews. Slips against such schedules would have to be thoroughly reviewed and a recovery plan developed.

Note, Day to Phillips, "Spacecraft redesign/test activity," March 16, 1967.

The Apollo 204 Review Board accepted the final report of its Administrative Procedures Panel (No. 15). The panel had been established February 7 to establish and document such activities as control of spacecraft work, logging and filing exhibits, logging Board activities, scheduling meetings, preparing agendas, and arranging for secretarial services and reproduction. During the investigation into the January 27 spacecraft fire, the panel had:

- Issued 25 Board administrative procedures.
- Established the administrative and Secretarial Support Office, which had provided support in two shifts seven days a week, unless otherwise required, with some additional third-shift support.
- Established the Photographic Data Control Center to correlate and distribute photographs and maintain a film library.
- Processed letters, telegrams, and telephone messages received offering assistance, recommendations, and comments.
- Periodically issued approved schedules of work.
- Established the Audio Magnetic Tape Library to control 0.64-centimeter voice-transmission tape recordings about spacecraft 012 during the Space Vehicle Plugs-Out Integrated Test.

"Board Proceedings" and Append. D. "Panels 12 thru 17," *Report of Apollo 204 Review Board*, pp. 3-29 and D-15-3 through D-15-5.

The Apollo 204 Review Board accepted the final report of the Fracture Areas Panel (No. 10). The panel had been charged with inspecting spacecraft 012 for structural failures in the January 27 fire and analyzing them from the standpoint of local pressure, temperature levels, direction of gas flow, etc.

The panel inspected the spacecraft structures while they were still at Launch Complex 34 and continued through removal of the CM heatshield. Structural damage reports were made coinciding with spacecraft disassembly phases. As major subsystems were removed from the spacecraft they were visually inspected. Buckles, fractures, cracks, melted areas, localized arcing or pitting in metal components, and obvious direct wire shorts were noted and documented.

Panel findings and determinations included:

Finding—Spacecraft data during the Plugs-Out Test gave indications from which a spacecraft pressure history could be estimated.

Determination—(a) The CM cabin structure had ruptured at 6:31:19.4 (± 0.1) p.m. EST January 27 at an estimated minimum cabin pressure of 20 newtons per sq cm (29 psia).

(b) The CM cabin structure had sustained cabin pressure in excess of its designed ultimate pressure of 8.9 newtons-per-sq-cm (12.9-psi) differential (19 newtons per sq cm; 27.6 psia). Cabin pressure at rupture probably reached 20 to 26 newtons per sq cm (29 to 37.7 psia).

(c) The estimated average gas temperature at rupture exceeded 644 kelvins (700°F).

1967
March
16

18

1967
March

Finding—The CM cabin ruptured in the aft bulkhead adjacent to its juncture with the aft sidewall.

Determination—The failure occurred because of excessive meridional tensile stress in the inner face sheet at the junction of the weld land to the thinner face sheet. The fracture originated on the right-hand side of the command module.

Finding—The CM cabin structure was penetrated in the aft bulkhead beneath the environmental control unit and the aft sidewall.

Determination—(a) The loss of structural integrity at these penetrations occurred after the primary rupture.

(b) Failure of the water glycol and oxygen lines near the environmental control unit resulted in local burning and melting of the adjacent structure.

Finding—The aft heatshield stainless-steel face sheets were melted and eroded.

Determination—The temperature of the flame and gas exiting from the fracture origin exceeded 1640 K (2500°F).

"Board Proceedings" and Append. D, "Panels 6 thru 10," *Report of Apollo Review Board*, pp. 3-30 and D-10-3 through D-10-7.

18-19

The final report of the Spacecraft and Ground Support Equipment Configuration Panel (No. 1) was accepted by the Apollo 204 Review Board. The panel had been assigned the task of documenting the physical configuration of the spacecraft and ground support equipment immediately before and during the January 27 fire, including equipment, switch position, and nonflight items in the cockpit. The panel was also to document differences from the expected launch configuration and configurations used in previous testing (such as altitude-chamber testing).

During the investigation the panel had discovered a number of items which might have had relevance to flame propagation:

- An engineering order, released at North American Aviation's Downey facility on January 20, provided direction to inspect the polyurethane foam in specified areas and coat the silicone rubber to meet flammability requirements. The direction was not recorded in the configuration verification record as of the start of the Space Vehicle Plugs-Out Integrated Test and was not accomplished on spacecraft 012. This item was considered as possibly significant in terms of fuel for the fire and a medium for flame propagation.

- Polyethylene bags covered the hose fitting for the drinking water dispenser and the battery-instrumentation cable and connectors and transducer, which were placed on the aft bulkhead near the batteries. The bags were made of nonflight materials.

- Two polyurethane pads, covered with Velostat, were stowed over couch struts. The pads were placed in the spacecraft to protect the struts, wiring, and aft bulkhead during the planned emergency egress at the end of

the test. These items were of nonflight material and were not documented by quality inspection records.

- Three packages of switching checklists from the Operational Checkout Procedure and one package of system malfunction procedures, in a manila folder, were stowed on the crew couches and on a shelf. These items were on unqualified paper and, while required for the test, they were not documented by quality inspection records.

- Nylon protective sleeves were covering all three crewmen's oxygen umbilicals. These sleeves were nonflight items.

- Three ground-support-equipment window covers had been temporarily installed to protect the windows and were nonflight items in the spacecraft at the time of the accident. Another such cover for the side hatch window was removed by the crew and stowed inside the command module. These covers were of nylon fabric; flight covers were made of aluminized Mylar.

- Velcro pile had been installed to protect the Velcro hood on the command module floor. It would have been removed before the flight.

- "Remove before flight" streamers installed in the command module interior were additional nonflight items.

- Polyethylene zipper tubing, installed to protect hand controller cables, was a nonflight item and was additional material in the command module.

The panel's summary of findings and determinations included:

Finding—Eighty engineering orders effective for spacecraft 012 had not been carried out at the time of the accident. Of these, twenty were specified to be completed after the test; four did not affect configuration.

Determination—Test requirements had no defined relationships with the open status of 56 engineering orders. The reason not all work items and engineering orders were closed was late receipt of changes or further work scheduled to be completed before launch.

Finding—Items not documented by quality inspection records had been placed on board the spacecraft during preparation for the Space Vehicle Plugs-Out Integrated Test.

Determination—Procedures for controlling entry of items into the spacecraft were not strictly enforced.

"Board Proceedings" and Append. D, "Panels 1 thru 4," *Report of Apollo 204 Review Board*, pp. 3-30 and D-1-5 through D-1-19.

The Apollo 204 Review Board accepted the final report of the Security Operations Panel (No. 14). The panel had been assigned to review existing security practices at KSC and supporting areas for adequacy and recommend any needed changes. Practices included access control, personnel sign-in requirements, buddy systems, and background investigation requirements.

1967
March

The panel's report submitted six findings and determinations, which included:

Finding—KSC security personnel or uniformed security personnel had been assigned to all locations requiring safeguarding measures, including launch vehicle stages and spacecraft from the time of arrival at KSC until the time of the January 27 accident.

Determination—The number of KSC and uniformed security personnel members used was adequate.

Finding—The Apollo Preflight Operations Procedures—dated October 17, 1966, and January 24, 1967—for access control of test and work areas, required that (1) access controls to spacecraft work areas be exercised by the contractor; (2) the contractor maintain a log of all personnel permitted access during off-shift and nonwork periods; and (3) the contractor control and log command module ingress and egress.

Determination—The procedures established in the Apollo Preflight Operations Procedures were not followed for spacecraft 012 in that (1) the contractor failed to exercise adequate access controls on the fifth, sixth, and seventh spacecraft levels; (2) the contractor failed to maintain an off-shift log; and (3) the command module ingress-egress log was inadequately maintained.

“Board Proceedings” and Append. D, “Panels 12 thru 17,” *Report of Apollo 204 Review Board*, pp. 3-30 and D-14-3 through D-14-7.

18-20

The Apollo 204 Review Board accepted the final report of its Origin and Propagation of Fire Panel (No. 5). The panel task had been to “conduct inspections, chemical analyses [and] spectrographic analysis of spacecraft, parts or rubble, or use any other useful techniques to establish point of [the CM 012] fire origin, direction and rate of propagation, temperature gradients and extremes. The nature of the fire, the type of materials consumed, the degree of combustion shall be determined.”

Following an intensive study—which considered ignition sources, description, and course of the fire—the panel listed 10 findings and determinations in its final report, including:

Finding—Severe damage to wiring was found at the bottom of the lower equipment bay along the aft bulkhead. Evidence of arcing was found and damage was less severe in the right-hand direction of this bay.

Determination—Electrical arcing in the extreme lower left-hand corner of this bay could have provided a primary ignition source.

Finding—Right-hand portions of the left-hand equipment bay were severely damaged. Wiring, tubing, and components in the carbon dioxide absorber compartment and oxygen/water panel compartment were burned and melted. Penetrations in the aft bulkhead and pressure vessel wall were observed. The carbon dioxide absorber compartment showed heavy fire

1967

March

damage; failure was due to pressure overload and melting caused by the fire in this area.

Determination—Electrical arcing in the right-hand portion of this bay could have provided a primary ignition source.

Finding—Evidence of electrical arcs from conductor to conductor and from conductor to structure were found.

Determination—No arc could be positively identified as the unique ignition source. Three were found that had all the elements needed to cause the disaster. Two of these showed evidence of poor engineering and installation.

"Board Proceedings" and Append. D, "Panel 5," *Report of Apollo 204 Review Board*, pp. 3-30 and D-5-3 through D-5-15.

The final report of the Ground Emergency Provisions Panel (Panel 13) accepted by the Apollo 204 Review Board submitted 14 findings and determinations. The panel had been charged with reviewing the adequacy of planned ground procedures for the January 27 spacecraft 012 manned test, as well as determining whether emergency procedures existed for all appropriate activities. The review was to concentrate on activity at the launch site and to include recommendations for changes or new emergency procedures if deemed necessary.

19

The panel approached its task in two phases. First, it reviewed the emergency provisions at the time of the CM 012 accident, investigating (1) the procedures in published documents, (2) the emergency equipment inside and outside the spacecraft, and (3) the emergency training of the flight crew and checkout test team. Second, the panel reviewed the methods used to identify hazards and ensure adequate documentation of safety procedures and applicable emergency instructions in the operational test procedures.

Findings and determinations included:

Finding—The applicable test documents and flight crew procedures for the AS-204 Space Vehicle Plugs-Out Integrated Test did not include safety considerations, emergency procedures, or emergency equipment requirements relative to the possibility of an internal spacecraft fire during the operation.

Determination—The absence of any significant emergency preplanning indicated that the test configuration (pressurized 100-percent-oxygen cabin atmosphere) was not classified as potentially hazardous.

Finding—The propagation rate of the fire in the accident was extremely rapid. Removal of the three spacecraft hatches, from either the inside or the outside, for emergency exit required a minimum of 40 to 70 seconds, respectively, under ideal conditions.

Determination—Considering the rapid propagation of the fire and the time constraints imposed by the spacecraft hatch configuration, it is doubtful that any amount of emergency preparation would have precluded injury to the crew before egress.

1967

March

Finding—Procedures for unaided egress from the spacecraft were documented and available. The AS-204 flight crew had participated in a total of eight egress exercises employing those procedures.

Determination—The 204 flight crew was familiar with and well trained in the documented emergency crew procedures for effecting unaided egress.

Finding—The spacecraft pad work team on duty at the time of the accident had not been given emergency training drills for combating fires in or around the spacecraft or for emergency crew egress. They were trained and equipped only for a normal hatch removal operation.

Determination—The spacecraft pad work team was not properly trained or equipped to effect an efficient rescue operation under the conditions resulting from the fire.

Finding—Frequent interruptions and failures had been experienced in the overall communications system during the operations preceding the accident. At the time the accident occurred, the status of the system was still under assessment.

Determination—The status of the overall communications was marginal for the support of a normal operation. It could not be assessed as adequate in the presence of an emergency condition.

Finding—Emergency equipment provided at the spacecraft work levels consisted of portable carbon dioxide fire extinguishers, rocket-propellant-fuel-handler's gas masks, and 4.4-centimeter-diameter fire hoses.

Determination—The existing emergency equipment was not adequate to cope with the conditions of the fire. Suitable breathing apparatus, additional portable carbon dioxide fire extinguishers, direct personnel evacuation routes, and smoke removal ventilation were significant items that would have improved the reaction capability of the personnel.

Finding—Under the existing method of test procedure processing at KSC, the safety offices reviewed only the procedures noted in the operational checkout procedure outline as involving hazards. Official approval by KSC and Air Force Eastern Test Range Safety was given after the procedure was published and released.

Determination—The scope of contractor and KSC Safety Office participation in test procedure development was loosely defined and poorly documented. Post-procedure-release approval by the KSC Safety Office did not ensure positive and timely coordination of all safety considerations.

"Board Proceedings"; Append. A, "Board Minutes"; and Append. D, "Panels 12 thru 17," in *Report of Apollo 204 Review Board*, pp. 3-28 through 3-30, A-112, and D-13-3 through D-13-13.

19

The Materials Work Panel (Panel 8, also referred to as Materials Review Panel) in its final report accepted by the Apollo 204 Review Board cited a number of findings on flammable materials in spacecraft 012. The panel's task had included the following, from its detailed work statement:

“• Assemble, summarize, compare and interpret requirements and data describing the flammability of nonmetallic materials exposed to the crew bay environment of the spacecraft and in related applications.

“• Specify and authorize performance of tests and/or analyses to furnish additional information as to flammability characteristics of these materials alone, and in combination with fluids known or postulated to have been in the spacecraft 012 cabin.

“• Panel No. 8, in support of Panel No. 5 (Origin and Propagation of Fire) shall interpret and implement the requirements for analyses of debris removed from the spacecraft.”

Panel 8 classified its findings in six categories: Materials Configuration; Routine Materials Test; Fire Initiation Special Investigation; Fire Propagation Special Investigation; Materials Installation Criteria and Controls; and Technical Data and Information Availability. The findings and determinations included:

Finding—Complete documentation identifying potentially combustible nonmetallic materials in spacecraft 012 was not available in a single readily usable format. A total of 2528 different potentially combustible nonmetallic materials that were probably used on spacecraft 012 was found by a review of available documentation.

Determination—The program for identifying and documenting nonmetallic materials used in the spacecraft, including their weights and surface areas, was not adequate.

Finding—Raschel Knit, Velcro, Trilock, and polyurethane foams burn about twice as fast (in the downward direction) in oxygen at a pressure of 11.4 newtons per sq cm (16.5 psia) as at 3.5 newtons per sq cm (5 psia).

Determination—The primary fuels for the fire burned more than twice as fast in the early stages of the spacecraft 012 fire in accident conditions (pressure of 11.4 newtons per sq cm) as in the space flight atmosphere for which they were evaluated (3.5 newtons per sq cm).

Finding—Surface and bulk damage of materials in spacecraft 012 varied from melting and blistering of aluminum alloys, combustion of Velcro, and burning of Teflon wire insulation to slight surface damage and melting of nylon fabrics.

Determination—The fire filled the spacecraft interior. The most intense heat was in the lower left front area around the environmental control unit. Surface temperatures in excess of 800 kelvins (1000°F) were reached in areas such as the front and left side of the spacecraft. Surface temperatures were less than 500 K (400°F) in isolated pockets above the right-hand couch.

Finding—The rate of flame propagation, the rate of pressure increase, the maximum pressures achieved, and the extent of conflagration in 3.5-newtons-per-sq-cm (5-psia) oxygen boilerplate tests was much less severe than observed in the 11.4-newton (16.5-psia) oxygen boilerplate tests.

1967

March

Burning or charring was limited to approximately 29 percent of the nonmetallic materials by oxygen depletion.

Determination—The conflagration that occurred in spacecraft 012 at a pressure of 11.4 newtons per sq cm would be far less severe and slower in a spacecraft operating with an oxygen environment at 3.5 newtons, if additional large quantities of oxygen are not fed into the fire.

Finding—North American Aviation materials selection specification requires that a material pass only a 500 K (400°F) spark-ignition test in oxygen at 10.1 newtons per sq cm (14.7 psia).

Determination—NAA criteria for materials flammability control were inadequate.

Finding—No flammability criteria or control existed covering nonflight items installed in CM 012 for test.

Determination—Lack of control of nonflight material could have contributed to the fire.

Finding—The NASA materials selection criteria required that a material pass a 500 K (400°F) spark-ignition test and a 1.27-cm-per-sec combustion rate (measured downward in oxygen at 3.5 newtons per sq cm). Raschel Knit and Velcro (hook) pass this test.

Determination—The NASA criteria for materials flammability were not sufficiently stringent.

Finding—The system for control of nonmetallic materials use at MSC during the design and development of government furnished equipment used in CM 012 depended on identification of noncompliance with criteria by the development engineers.

Determination—The NASA materials control system was permissive to the extent that installation or use of flammable materials were not adequately reviewed by a second party.

Finding—Nonmetallic materials selection criteria used by North American and NASA were not consistent. The NASA criteria, although more stringent, were not contractually imposed on the spacecraft contractor.

Determination—Materials were evaluated and selected for use in CM 012 using different criteria. Application of the NASA criteria to the command module would have reduced the amount of the more flammable materials (Velcro and Uralane foam).

Finding—Alternate materials that are nonflammable or significantly less flammable than those used on spacecraft 012 were available for many applications.

Determination—The amount of combustible material used in command modules can be limited.

Finding—Current information and displays of the potentially flammable materials configuration of spacecraft 012 were not available before the fire.

1967

March

Determination—Maintenance of data and displays at central locations and test sites for management visibility and control of flammable materials is feasible and useful.

"Board Proceedings"; Append. A, "Board Minutes"; and Append. D, "Panels 6 thru 10," in *Report of Apollo 204 Review Board*, pp. 3-30, A-112, and D-8-3 through D-8-35.

NASA announced it would use the Apollo-Saturn 204 launch vehicle to launch the first lunar module on its unmanned test flight. Since the 204 vehicle was prepared and was not damaged in the Apollo 204 fire in January, it would be used instead of the originally planned AS-206.

20

NASA News Release 67-67, March 20, 1967.

The Deputy Administrator of NASA designated Langley Research Center custodian of all materials dealing with the investigation and review of the January 27 Apollo 204 accident. Review Board Chairman Floyd Thompson, LaRC, who had the responsibility of determining the materials to be included in the final repository, determined that the following categories of materials were to be preserved:

20

1. Reports, files, and working materials;
2. Medical reports;
3. Spacecraft 012 command module, its systems, components, and related drawings.

Category 1 materials would be stored at LaRC, Category 2 at MSC, and Category 3 at KSC.

In other actions Robert W. Van Dolah, Chairman of the Origin and Propagation of Fire Panel, reported on a test being conducted in CM 014 to attempt to establish the amount of static electricity that might be generated by a suited crewman; and members of the Board met with MSC Director Robert R. Gilruth and members of his staff, as well as management and engineering personnel of North American Aviation, for a presentation concerning solder joints in the CM.

"Board Proceedings," pp. 3-30, 3-31.

Final report of the Disassembly Activities Panel (No. 4) was accepted by the Apollo 204 Review Board. Panel 4 had been assigned to develop procedures for disassembly of spacecraft 012 for inspection and failure analysis. Disassembly was to proceed step by step in a manner permitting maximum information to be obtained without disturbing the evidence—in both the cockpit and the area outside the pressure hull. Cataloging documentary information within the spacecraft and displaying the removed items were a part of the required procedures.

21

1967

Procedures followed included the following actions:

March

- Immediately after the January 27 accident, NASA KSC Security placed Launch Complex 34 under additional security. Special guards were assigned to the service structure and to the adjustable level at the entrance of the CM. Controls were established for personnel access to the service structure and the CM.

- After the accident, before disturbing any items in the spacecraft, a series of photographs was taken. A step-by-step photography method was established as a standard operating procedure for the Disassembly Activities Panel.

- The first step toward an orderly disassembly was to ensure safe working conditions at the spacecraft. A meeting with KSC and Air Force Eastern Test Range Safety personnel established procedures and safety rules.

- After the couches were removed, a special false floor was suspended from the couch strut fittings to provide access to the entire inside of the spacecraft without disturbing any evidence. The false floor was fabricated from aluminum angles supporting 2-centimeter-thick, 46-centimeter plexiglass squares.

- The Review Board appointed a Panel Coordination Committee to carry out new procedures to ensure closely controlled and coordinated equipment removal.

The Disassembly Activities Panel cataloged and displayed the 1261 items removed from spacecraft 012 during the investigation. The Pyrotechnics Installation Building (PIB) at KSC was assigned as an area in which components removed from the command module could be placed in bonded storage yet still be available for inspection by investigative personnel. The following areas were established in the PIB:

1. Bond room—a bonded area to receive components as they were removed from CM 012. This area was provided with a receiving table; 10 storage cabinets for small components; and areas for large components and items associated with the investigation but not from the command module itself.

2. Astronaut equipment room and work room—an area in which the spacesuits and other government furnished crew equipment were investigated.

3. Bonded display area—an area in which components could be displayed under controlled conditions to permit investigators to examine CM 012 components visually.

4. Command module 012 work area—The command module was placed in a supporting ring within an existing workstand in the PIB and remained in this area until the aft heatshield was removed. The CM was then transferred to a standard support ring in the north end of the building. Technicians continued the disassembly activities while the CM was in these areas.

1967

March

5. Spacecraft 014 CM—Spacecraft 014 CM (identical in configuration to spacecraft 012) was shipped to KSC on February 1 to assist the Apollo 204 Review Board in the investigation. This CM was placed in the PIB and was used for practicing difficult removals of CM 012 components.

6. Mockup No. 2—Mockup No. 2, a full-scale plywood command module, was brought to KSC and placed in the PIB February 8. The mockup had been configured with Velcro, debris traps, couch positioning, etc., to duplicate CM 012 configuration at the time of the fire.

7. Half-scale mockup—A half-scale mockup of the CM interior was placed in the bonded display area February 8 to display half-scale interior surface photographs taken after the fire in CM 012.

“Board Proceedings,” and Append. D, “Panels 1 thru 4,” *Report of Apollo 204 Review Board*, pp. 3-31 and D-4-3 through D-4-8.

The Apollo 204 Review Board accepted the final report of its Test Environment Panel (Panel 2). Panel 2 had been assigned responsibility for the history of all test environments encountered by spacecraft 012 that were considered germane to system validation from a fire hazard standpoint, including qualification testing of systems and subsystems. The panel was particularly to emphasize qualification tests in pure oxygen with regard to pressures, temperature, time of exposure, and simulation of equipment malfunctions. It was also to indicate any deficiencies in the test program related to the problem; comparison with previous tests of appropriate flight, house, or boilerplate spacecraft; and documentation of any problems encountered which related to fire hazard.

25

The panel reviewed all tests pertinent to the investigation. The qualification tests were reviewed at MSC, covering more than 1000 documents. Vehicle tests were reviewed at North American Aviation's Downey, Calif., facility, covering more than 500 documents. Summaries of these efforts were reviewed by the panel at KSC to determine any test program deficiencies.

The final report of the panel included six findings and determinations. Among them were:

Finding—Not all crew compartment equipment had been tested as explosion proof.

Determination—Testing of possible ignition sources had been insufficient.

Finding—Some CM equipment exhibited arcing or shorting either during certification or during spacecraft 012 testing. There was no positive way to determine from the records reviewed whether spacecraft anomalies (possibly caused by an arc or a short) were reviewed by system engineers and the test conductor before a test.

Determination—Review of possible ignition sources before manned testing was inadequate.

1967

March

Finding—Not all equipment installed in CM 012 at the time of the accident was intended for flight (some components were installed for test purposes only).

Determination—The suitability of this equipment in the CM for this test was not established.

“Board Proceedings” and Append. D, “Panels 1 thru 4,” *Report of the Apollo 204 Review Board*, pp. 3-32 and D-2-3 through D-2-8.

March 25-

April 24

NASA Hq. Office of Manned Space Flight informed KSC, MSFC, and MSC of approved designations for Apollo and Apollo Applications missions: (1) all Apollo missions would be numbered sequentially in the order flown, with the next mission to be designated Apollo 4, the following one Apollo 5, etc., and (2) the Apollo Applications missions would be designated sequentially as AAP-1, AAP-2, etc. The number designations would not differentiate between manned and unmanned or uprated Saturn I and Saturn V missions.

In a letter to George E. Mueller, OMSF, on March 30, MSC Deputy Director George M. Low offered two suggestions, in keeping with the intent of the NASA instruction yet keeping the designation Apollo 1 for spacecraft 012. NASA Hq. had approved that designation before the January 27 fire claimed the lives of Astronauts Virgil I. Grissom, Edward H. White II, and Roger B. Chaffee; and their widows requested that the designation be retained. The suggestions were:

1. Consider the AS-201, 202, and 203 missions part of the Saturn I (as opposed to uprated Saturn I) series; reserve the designation Apollo 1 for spacecraft 012; and number the following flights Apollo 2, etc., or
2. Designate the next flight Apollo 4, as indicated by Headquarters, but apply the scheme somewhat differently for missions already flown. Specifically, put the Apollo 1 designation on spacecraft 012 and then, for historic purposes, designate 201 as mission 1-a, 202 as mission 2 and 203 as mission 3.

A memorandum to the NASA space flight Centers, North American Aviation, and certain Headquarters personnel from the NASA Assistant Administrator for Public Affairs on April 3 stated that the Project Designation Committee had approved the Office of Manned Space Flight's recommendations and that Mueller had begun implementation of the designations.

On April 24, OMSF further instructed the Centers that AS-204 would be officially recorded as Apollo 1, “first manned Apollo Saturn flight—failed on ground test.” AS-201, AS-202, and AS-203 would not be renumbered in the “Apollo” series, and the next mission would be Apollo 4.

TWX, Mueller, NASA OMSF, to KSC, MSFC, MSC, “Apollo and AAP Mission Designation,” March 25 and April 24, 1967; ltr., Low to Mueller, March 30, 1967; memo, Julian Scheer, NASA Assistant Administrator for Public Affairs, to distr., April 3, 1967.

A meeting at MSC considered fire detection systems and fire extinguishers. Participants were G. M. Low, K. S. Kleinknecht, A. C. Bond, J. N. Kotanchik, J. W. Craig, M. W. Lippitt, and G. W. S. Abbey. Craig and Lippitt had visited Wright Field, Ohio, and from their findings the following conclusions were reached: (1) no fire detection system was available for incorporation into the Apollo spacecraft; (2) a reliable system would be desirable, but the system must not give false alarms when used in a closed spacecraft environment and yet must give adequate warning of fire; (3) two kinds of systems appeared to be in varying states of development—systems using infrared or ultraviolet sensors and systems sensing ionized particles or condensation nuclei in the atmosphere; (4) a work statement should be prepared, with the help of personnel at Wright Field, for the purpose of receiving specific proposals on available systems; and (5) the ultimate goal should be to develop a system ready for flight use within six months.

1967
March
27

Memo for the Record, George M. Low, "Fire detection/extinguishment," March 27, 1967.

Apollo 204 Review Board Chairman Floyd Thompson asked for a report on the Pyrotechnic Installation Building activity. Disassembly of spacecraft 012 had been completed March 27. Of 1261 items logged through the bond room for display to Board and panel personnel, about 1000 items were from the CM.

28

The final report of the Screening Committee was distributed to the Board by George T. Sasseen, KSC, for review. Sasseen stated that the following items would be retained as Category A (items damaged or identified as suspect or associated with anomalies).

- Lower equipment bay junction box cover plate
- Command pilot's torso harness
- Velcro and Raschel netting
- Static inverter 2
- Main display control panel 8
- Instrumentation data distribution panel J800/J850
- Octopus cable.

Maxime A. Faget, MSC, advised the Board that the lithium hydroxide cartridge had been sent to MSC for analysis. Hubert D. Calahan, OMSF, was appointed courier to handcarry the item to MSC and Richard S. Johnston, MSC, was designated the Board's witness for the analysis. MSC's Crew Systems Laboratory was to make the analysis and report to the Board. The analysis was to identify contaminants to determine the quantity of carbon dioxide in the lithium hydroxide.

William D. Mangan, Langley Research Center, joined the legal staff supporting the Board.

"Board Proceedings," pp. 3-32, 3-33.

1967

March

29

At the request of the Manager of the MSC Lunar Surface Programs Office, NASA Associate Administrator for Space Science and Applications Homer E. Newell considered alternate Array B configurations of the Apollo Lunar Surface Experiments Package to alleviate a weight problem. Instead of a single array, he selected two configurations for ALSEP III and ALSEP IV:

ALSEP III Experiments: Passive Seismic, Heat Flow (w/Lunar Drill), Cold Cathode Gauge, and Charged Particle Lunar Environment.

ALSEP IV Experiments: Passive Seismic, Active Seismic, Suprathermal Ion Detector/Cold Cathode Gauge, and Charged Particle Lunar Environment.

Newell requested that both configurations be built but that, if program constraints permitted the fabrication of only one array for ALSEP II and IV, ALSEP III should be given the preference. The Apollo Program Director concurred in the Newell recommendation.

Ltr., Apollo Program Director, NASA Hq., to R. O. Piland, MSC, March 29, 1967.

29-30

The Apollo Site Selection Board meeting at NASA Hq. March 29 heard MSC presentations on lunar landing site selection constraints, results of the *Orbiter II* screening, and reviews of the tasks for site analysis. MSC made recommendations for specific sites on which to concentrate during the next four months and recommended that the landing sites for the first lunar landing mission be selected by August 1. The Board accepted the recommendations. A Surveyor and Orbiter meeting the following day considered the targeting of the Surveyor C mission and the Lunar Orbiter V mission. MSC representatives at the two meetings were John Eggleston and Owen E. Maynard.

Memo, Chief, Mission Operations Div., MSC, to Manager, ASPO, "Trip Report—Apollo Site Selection Board and Surveyor/Orbiter Utilization Committee Meetings," April 20, 1967.

March 29-

April 4

H. C. Creighton, A. R. Goldenberg, and Guy N. Witherington, all of KSC, inspected spacecraft 101 wire bundles March 29 at the request of CSM Manager Kenneth S. Kleinknecht of MSC. Kleinknecht had asked that they give him a recommendation as to whether the bundles should be removed or whether they could be repaired in place. On April 4, they reported to Kleinknecht that time had not been sufficient to determine the complete status of the wiring. A superficial inspection about five-percent complete had indicated some serious discrepancies, for which they made some recommendations, but they recommended a more detailed inspection of the spacecraft 101 wire bundles.

Memo, Creighton, Goldenberg, and Witherington to Kleinknecht, "Condition of Spacecraft 101 Wire Bundles," April 4, 1967.

30

The Apollo 204 Review Board accepted the report of its Sequence of Events Panel (No. 3), which had been charged with analyzing data from immediately before and during the January 27 fire, including digital,

1967

March

analog, voice communications, and photography. The data was required to display significant events as they occurred with the precise time tag. Time histories of all continuous or semicontinuous recorded parameters and correlation of parameter variations and events were to be recorded, as well as interpretation of the analysis results. Where pertinent, normal expected variations were to be compared with those actually obtained.

Panel 3 had served as a separate panel from January 31 through February 23, when it was merged with the Integration Analysis Panel (No. 18). Panel 3 reported one finding and one determination:

Finding—The data recorded from the spacecraft and ground instrumentation system during the Spacecraft Plugs-Out Test were found to be valid except for three brief dropouts after 6:31:17 EST, January 27 (13 seconds after the pilot reported “fire in the cockpit”). All onboard data transmission ended about 6:31:22 EST.

Determination—The onboard instrumentation system functioned normally before and during the initial phase of the fire. There were no indicated malfunctions in any of the instrumentation sensors during this period.

“Board Proceedings” and Append. D, “Panels 1 thru 4,” *Report of Apollo 204 Review Board*, pp. 3-33 and D-3-3 through D-3-6.

The Apollo 204 Review Board met with its Test Procedures Review Panel (Panel No. 7) to complete acceptance of the panel’s final report. The panel had been established February 7 to document test procedures actually employed during the day of the January 27 accident and to indicate deviations between planned procedures and those used. The panel was to determine changes that might alleviate fire hazard conditions or that might provide for improved reaction or corrective conditions and review the changes for applicability to other tests.

30

Among the panel’s findings and determinations were:

Finding—209 pages of the 275-page Operational Checkout Procedure (OCP) were revised and released on the day before the test. However, less than 25 percent of the line items were changed. Approximately one percent of the change was due to errors in technical content in the original issue of the procedure. In addition, 106 deviations were written during the test.

Determination—Neither the revision nor the deviations were known to have contributed specifically to the incident. The late timing of the change release, however, prevented test personnel from becoming adequately familiar with the test procedure before use.

Finding—During the altitude chamber tests, the cabin was pressurized at pressures greater than sea level with an oxygen environment two and a half times as long as the cabin was pressurized with oxygen before the accident during Plugs-Out Test.

1967

March

Determination—The spacecraft had successfully operated with the same cabin conditions in the chamber for a greater period of time than on the pad up to the time of the accident.

Finding—Troubleshooting the communication problem was not controlled by any one person, and was at times independently run from the spacecraft, Launch Complex 34 Blockhouse, and the Manned Spacecraft Operations Building. Communications switching, some of which was not called out in OCP, was performed without the control of the Test Conductor.

Determination—The uncontrolled troubleshooting and switching contributed to the difficulty experienced in attempting to assess the communication problem.

Finding—KSC was not able to ensure that the spacecraft launch operations plans and procedures adequately satisfied, in a timely way, the intent of MSC. Changes in spacecraft testing by KSC could not be kept in phase with the latest requirements of MSC. Prelaunch checkout requirements were not formally transmitted to KSC from MSC.

Determination—Prelaunch-test-requirements control for the Apollo spacecraft program was constrained by slow response to changes, lack of detailed KSC–MSC inter-Center agreements, and lack of official NASA-approved test specifications applicable to prelaunch checkout.

Finding—The decision to perform the Plugs-Out Test with the flight crew, closed hatch, and pure oxygen cabin environment made on October 31, 1966, was a significant change in test philosophy.

Determination—There was no evidence that this change in test philosophy was made so late as to preclude timely incorporation into the test procedure.

“Board Proceedings” and Append. D, “Panels 6 thru 10,” *Report of Apollo 204 Review Board*, pp. 3-33 and D-7-3 through D-7-13.

30

The Apollo 204 Review Board was scheduled to review the final report of its Historical Data Panel (Panel No. 6). The panel had been assigned to assemble, summarize, and interpret historical data concerning the spacecraft and associated systems pertinent to the January 27 fire. The data were to include such records as the spacecraft log, failure reports, and other quality engineering and inspection documents. In addition the panel prepared narratives to reflect the relationship and flow of significant review and acceptance points and substantiating documentation and presented a brief history of prelaunch operations performed on spacecraft 012 at Kennedy Space Center.

In its final report to the Review Board the Historical Data Panel submitted eight findings and determinations. Among them were:

1967

March

Finding—The Ingress-Egress Log disclosed several instances where tools and equipment were carried into the spacecraft, but the log did not indicate these items had been removed.

Determination—Maintenance of the Ingress-Egress Log was inadequate.

Finding—Inspection personnel did not perform a prescheduled inspection with a checklist before hatch closing.

Determination—Inspection personnel could not verify specific functions during that period.

Finding—At the time of the spacecraft 012 shipment to KSC, the contractor submitted an incomplete list of open items. A revision of that list significantly and substantially enlarged the list of open items.

Determination—The true status of the spacecraft was not identified by the contractor.

"Board Proceedings" and Append. D, "Panels 6 thru 10," *Report of Apollo 204 Review Board*, pp. 3-33 and D-6-3 through D-6-7.

The Apollo 204 Review Board accepted the final report of its Design Review Panel (No.9), whose duty had been to conduct Critical Design Reviews of systems or subsystems that might be potential ignition sources within the Apollo command module cockpit or that might provide a combustible condition in either normal or failed conditions. The panel was also to consider areas such as the glycol plumbing configuration; electrical wiring and its protection, physical and electrical; and such potential ignition sources as motors, relays, and corona discharge. Other areas would include egress augmentation and the basic cabin atmosphere concept (one-gas versus two-gas).

30

The contemplated spacecraft configuration for the next scheduled manned flight (spacecraft 101, Block II) was significantly different from that of spacecraft 012 (Block I), in which the January 27 fire had occurred. Therefore, both configurations were to be reviewed—the Block I configuration as an aid in determining possible sources for the fire, the Block II to evaluate the system design characteristics and potential design change requirements to prevent recurrence of fire.

The panel's final report to the Review Board contained findings on ignition and flammability, cabin atmosphere, review of egress process, and review of the flight and ground voice communications. Among them were:

Finding—Flammable, nonmetallic materials were used throughout the spacecraft. In the Block I and Block II spacecraft design, combustible materials were contiguous to potential ignition sources.

Determination—In the Block I and Block II spacecraft design, combustible materials were exposed in sufficient quantities to constitute a fire hazard.

1967

March

Finding—The spacesuit contained power wiring to electronic circuits. The astronauts could be electrically insulated.

Determination—Both the power wiring and potential for static discharge constituted possible ignition sources in the presence of combustible materials. The wiring in the suit could fail from working or bending.

Finding—Residues of RS89 (inhibited ethylene glycol/water solution) after drying were both corrosive and combustible. RS89 was corrosive to wire bundles because of its inhibitor.

Determination—Because of the corrosive and combustible properties of the residues, RS89 coolant could, in itself, provide all of the elements of a fire hazard if it leaked onto electrical equipment.

Finding—Water/glycol was combustible, although not easily ignited.

Determination—Leakage of water/glycol in the cabin would increase risk of fire.

Finding—Deficiencies in design, manufacture, and quality control were found in the postfire inspection of the wire installation.

Determination—There was an undesirable risk exposure, which should have been prevented by both the contractor and the government.

Finding—The spacecraft atmosphere control system design was based on providing a pure oxygen environment.

Determination—The technology was so complex that, to provide diluent gases, duplication of the atmosphere control components as well as addition of a mechanism for oxygen partial-pressure control would be required. These additions would introduce additional crew-safety failure modes into the flight systems.

Finding—Sixty seconds were required for unaided crew egress from the CM. The hatch could not be opened with positive cabin pressure above approximately 0.17 newtons per sq cm (0.25 psi). The vent capacity was insufficient to accommodate the pressure buildup in the Apollo 204 spacecraft.

Determination—Even under optimum conditions emergency crew egress from Apollo 204 spacecraft could not have been accomplished in sufficient time.

Finding—During the January 27 Apollo 204 test, difficulty was experienced in communicating from ground to spacecraft and among ground stations.

Determination—The ground system design was not compatible with operational requirements.

"Board Proceedings" and Append. D, "Panels 6 thru 10," *Report of Apollo 204 Review Board*, pp. 3-33 and D-9-3 through 3-9-13.

The Integration Analysis Panel (No. 18) was rewriting its final report to the Apollo 204 Review Board. Panel 18 had been assigned to review information from all task groups and make the final technical integration of the evidence. Panels 3 and 16 had been merged with Panel 18 on February 23. In its final report to the Review Board, Panel 18 listed:

1967

March

31

Findings—Several arcing indications were observed in the CM left front sector and a voltage transient was noted in all three phases of AC Bus 2. This transient was most closely simulated by a power interruption or short circuit on DC Bus B. Physical evidence and witness statements indicated the progress of the fire to be from the left side of the spacecraft. Simulations and tests indicated that combustion initiation by electrostatic discharge or chemical action was not probable. No physical evidence of prefire overheating of mechanical components or heating devices was found.

Determinations—No single ignition source could be conclusively identified. The most probable initiator was considered to be the electrical arcing or shorting in the left front sector of the spacecraft. The location best fitting the total available information was that where environmental control system instrumentation power wiring ran into the area between the environmental control unit and the oxygen panel.

Finding—All spacecraft records were reviewed by the various panels and the results were screened by Panel 18.

Determination—No evidence was found to correlate previously known discrepancies, malfunctions, qualification failures or open work items with the source of ignition.

Finding—At the time of the observed fire, data including telemetry and voice communications indicated no malfunctioning spacecraft systems (other than the live microphone).

Determination—Existing spacecraft instrumentation was insufficient by itself to provide data to identify the source of ignition.

“Board Proceedings” and Append. D, “Panel 18,” *Report of Apollo 204 Review Board*, pp. 3-33 and D-18-3 through D-18-51.

The final report of the Medical Analysis Panel (No. 11) to the Apollo 204 Review Board was processed for printing. The panel had been assigned to provide a summary of medical facts with appropriate medical analysis for investigation of the January 27 fire. Examples were cause of death, pathological evidence of overpressure, and any other areas of technical value in determining the cause of accident or in establishing corrective action.

31

The panel report indicated that at the time of the accident two NASA physicians were in the blockhouse monitoring data from the senior pilot. Upon hearing the first voice transmission indicating fire, the senior NASA physician turned from the biomedical console to look at the bank of television monitors. When his attention returned to the console the bioinstrumentation data had stopped. The biomedical engineer in the

1967

March

Acceptance Checkout Equipment (ACE) Control Room called the senior medical officer for instructions. He was told to make the necessary alarms and informed that the senior medical officer was leaving his console. The two NASA physicians left the blockhouse for the base of the umbilical tower and arrived there shortly before ambulances and a Pan American physician arrived at 6:43 p.m. The three physicians went to the spacecraft; time of their arrival at the White Room was estimated to be 6:45 p.m. EST.

By this time some 12 to 15 minutes had elapsed since the fire began. After a quick evaluation it was evident that the crew had not survived the heat, smoke, and burns and it was decided that nothing could be gained by attempting immediate egress and resuscitation.

Panel 11's 24 findings included:

Finding—Biomedical data at the time of the accident were received from only the senior pilot. The data consisted of one lead of electrocardiogram, one lead of phonocardiogram, and impedance pneumogram (respiration). The data was received by telemetry and from the onboard medical data acquisition system.

Determination—This configuration was normal for the test.

Finding—At 6:31:04 p.m. there was a marked change in the senior pilot's respiratory and heart rates on the biomedical tape. There was also evidence of muscle activity in the electrocardiogram and evidence of motion in the phonocardiogram. The heart rate continued to climb until loss of signal.

Determination—This physiological response is compatible with the realization of an emergency situation.

Finding—Voice contact with the crew was maintained until 6:31:22.7 p.m.

Determination—At least one crew member was conscious until that time.

Finding—Hatches were opened at approximately 6:36 p.m. and no signs of life were detected. Three physicians looked at the suited bodies at approximately 6:45 p.m. and decided that resuscitation efforts would be to no avail.

Determination—Time of death could not be determined from this finding.

Finding—"The cause of death of the Apollo 204 Crew was asphyxia due to inhalation of toxic gases due to fire. Contributory cause of death was thermal burns."

Determination—It could be concluded that death occurred rapidly and that unconsciousness preceded death by some increment of time. The fact that an equilibrium had not been established throughout the circulatory system indicated that blood circulation stopped rather abruptly before an equilibrium could be reached.

Finding—Panel 5 had estimated that significant levels (more than two percent) of carbon monoxide were in the spacecraft atmosphere by 6:31:30 p.m. EST. By this time at least one spacesuit had failed, introducing cabin gases to all suit loops.

Determination—The crew was exposed to a lethal atmosphere when the first suit was breached.

Finding—The distribution of carbon monoxide in body organs indicated that circulation stopped rather abruptly when high levels of carboxyhemoglobin reached the heart.

Determination—Loss of consciousness was caused by cerebral hypoxia due to cardiac arrest from myocardial hypoxia. Factors of temperature, pressure, and environmental concentrations of carbon monoxide, carbon dioxide, oxygen, and pulmonary irritants were changing at extremely rapid rates. It was impossible from available information to integrate these variables with the dynamic physiological and metabolic conditions they produced, to arrive at a precise statement of the time when consciousness was lost and when death supervened. Loss of consciousness was estimated as at between 15 and 30 seconds after the first suit failed. Chances of resuscitation decreased rapidly thereafter and were irrevocably lost within 4 minutes.

Finding—The purge with 100-percent oxygen at above sea-level pressure contributed to the propagation of fire in the Apollo 204 spacecraft.

Determination—The oxygen level was the planned cabin environment for testing and launch, since prelaunch denitrogenation was necessary to forestall the possibility of the astronauts' suffering the bends. A comprehensive review of operational and physiological tradeoffs of various methods of denitrogenation was in progress.

"Board Proceedings" and Append. D, "Panel 11," *Report of Apollo 204 Review Board*, pp. 3-33 and D-11-3 through D-11-9.

ASPO Manager Joseph F. Shea requested that the White Sands Test Facility be authorized to conduct the descent propulsion system series tests starting April 3 and ending about May 1. The maximum expected test pressure would be 174 newtons per sq cm (253 psia), normal maximum operating pressure. The pressure could go as high as 179 newtons per sq cm (260 psia) according to the test to be conducted.

Required leak check operations were also requested at a maximum pressure of 142 newtons per sq cm (206 psia), with a design limit of 186 newtons per sq cm (270 psia). The test fluids would be compatible with the titanium alloy at the test pressures. The test would be conducted in the Altitude Test Stand, where adequate protection existed for isolating and containing a failure. MSC Director Robert R. Gilruth approved the request the same day.

Memo, Shea to Gilruth, "Request for authorization to conduct a pressure test," March 31, 1967.

In reply to a request from NASA Hq., CSM Manager Kenneth S. Kleinknecht told Apollo Program Director Samuel C. Phillips that

1967

March

31

April

1

1967**April**

replacement of the service module 017 oxidizer tank was based on a double repair weld of the method 2 kind in that tank. This kind of repair, he said, resulted in a weld chemistry similar to the weld on the S-IVB helium bottle that had failed, as had only recently been determined by examination of the secondary-propulsion-system tank repair weld. There was insufficient proof that titanium hydride concentrations could not occur in the double method-2 repair weld, and replacement of the tank would preclude any question as to the integrity of the tank. The decision was delayed as long as possible in the hope of developing technical justification of weld integrity. When that was not achieved and there was little confidence that justification could be developed in the near future, the decision was made directing the tank change. The activity would not cause additional schedule time loss, as it was already necessary to repeat the spacecraft integrated test because of wiring rework.

Ltr., Kleinknecht to Phillips, "Delay in Direction to Effect Service Module Tank Change," April 1, 1967.

- 5 The mission profile for the first manned Apollo flight would be based on that specified in Appendix AS-204 in the Apollo Flight Mission Assignments Document dated November 1966, the three manned space flight Centers were informed. Apollo Program Director Samuel C. Phillips said the complexity of the mission was to be limited to that previously planned, and therefore consideration of a rendezvous exercise would be dependent upon the degree of complication imposed on the mission. "There will be no additions that require major new commitments such as opening a CM hatch in space or exercising the docking subsystem."

TWX, Phillips to MSC, MSFC, and KSC, "First Manned Mission," April 5, 1967.

- 5 The Apollo 204 Review Board transmitted its final formal report to NASA Administrator James E. Webb, each member concurring in each of the findings, determinations, and recommendations concerning the January 27 spacecraft fire that took the lives of three astronauts.

During the review the Board had adhered to the principle that reliability of the CM and the entire system involved in its operation was a requirement common to both safety and mission success. Once the CM had left the earth's environment the occupants were totally dependent on it for their safety. It followed that protection from fire as a hazard required much more than quick egress. Egress was useful only during test periods on earth when the CM was being readied for its mission and not during the mission itself. The risk of fire had to be faced, but that risk was only one factor pertaining to CM reliability that must receive adequate consideration. Design features and operating procedures intended to reduce the fire risk must not introduce other serious risks to mission success and safety.

The House Committee on Science and Astronautics' Subcommittee on NASA Oversight held hearings on the Review Board report April 10-12, 17,

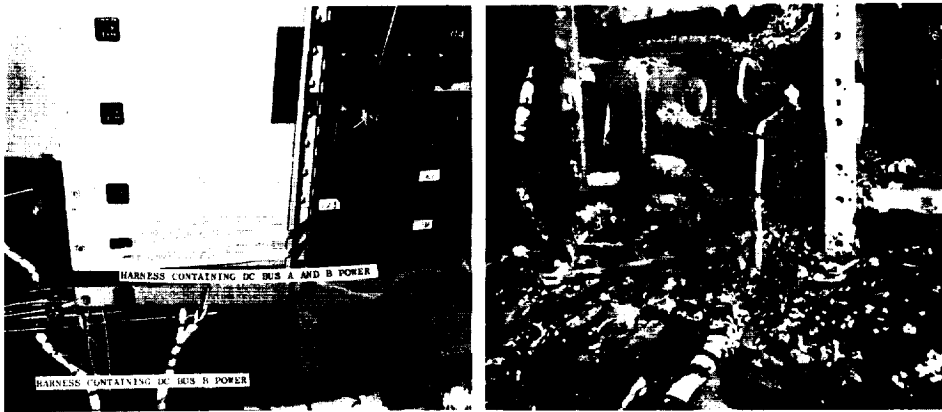

The Apollo 204 Review Board studied Apollo spacecraft 014 (left) in its investigation of the January 27, 1967, fire in the similar CM 012 (right, photographed after the fire). The interior views show the forward section of the left-hand equipment bay, below the environmental control unit in each spacecraft. The DC power cable crosses over aluminum tubing and under a lithium hydroxide access door (removed in the photo of the damaged CM 012). The Board determined this was the area of the most probable initiator of the fire.

and 21 and May 10. Senate Committee on Aeronautical and Space Sciences hearings were held April 11, 13, and 17 and May 4 and 9 (see May 9–10, 1967, and Appendix 8).

1967
April

Findings, determinations, and recommendations of the Apollo 204 Review Board were:

1. *Finding*—(a) A momentary power failure occurred at 6:30:55 p.m. EST (23:30:55 GMT). (b) Evidence of several arcs was found in the postfire investigation. (c) No single ignition source of the fire was conclusively identified.

Determination—The most probable initiator was an electrical arc in the sector between the $-Y$ and $+Z$ spacecraft axes. The exact location best fitting the total available information was near the floor in the lower forward section of the left-hand equipment bay where environmental control system instrumentation power wiring led into the area between the environmental control unit and the oxygen panel. No evidence was discovered that suggested sabotage.

2. *Finding*—(a) The CM contained many classes of combustible material in areas contiguous to possible ignition sources. (b) The test was conducted with a 100-percent oxygen atmosphere at 11.5 newtons per sq cm (16.7 psia).

Determination—The test conditions were extremely hazardous.

Recommendation—The amount and location of combustible materials in the CM must be severely restricted and controlled.

1967

April

3. *Finding*—(a) The rapid spread of fire increased pressure and temperature, rupturing the CM and creating a toxic atmosphere. “Death of the crew was from asphyxia due to inhalation of toxic gases due to fire. A contributory cause of death was thermal burns.” (b) Non-uniform distribution of carboxyhemoglobin was found by autopsy.

Determination—Autopsy data led to the medical opinion that unconsciousness occurred rapidly and that death followed soon thereafter.

4. *Finding*—Because of internal pressure, the CM inner hatch could not be opened before rupture of the CM.

Determination—The crew was never capable of effecting emergency egress because of the pressurization before the rupture and their loss of consciousness soon after rupture.

Recommendation—The time required for egress of the crew should be reduced and the operations necessary for egress be simplified.

5. *Finding*—The organizations responsible for planning, conducting, and safety of this test failed to identify it as being hazardous. Contingency preparations to permit escape or rescue of the crew from an internal CM fire were not made.

(a) No procedures for this kind of emergency had been established either for the crew or for the spacecraft pad work team. (b) The emergency equipment in the White Room and on the spacecraft work levels was not designed for the smoke condition resulting from a fire of this nature. (c) Emergency fire, rescue, and medical teams were not in attendance. (d) Both the spacecraft work levels and the umbilical tower access arm contained features such as steps, sliding doors, and sharp turns in the egress paths which hindered emergency operations.

Determination—Adequate safety precautions were neither established nor observed for this test.

Recommendations—(a) Management should continually monitor the safety of all test operations and ensure the adequacy of emergency procedures. (b) All emergency equipment (breathing apparatus, protective clothing, deluge systems, access arm, etc.) should be reviewed for adequacy. (c) Personnel training and practice for emergency procedures should be given regularly and reviewed before a hazardous operation. (d) Service structures and umbilical towers should be modified to facilitate emergency operations.

6. *Finding*—Frequent interruptions and failures had been experienced in the overall communication system during the operations preceding the accident.

Determination—The overall communication system was unsatisfactory.

Recommendation—(a) The ground communication system should be improved to ensure reliable communications among all test elements as soon as possible and before the next manned flight. (b) A detailed design review should be conducted on the entire spacecraft communication system.

1967

April

7. *Finding*—(a) Revisions in the Operational Checkout Procedure for the test were issued at 5:30 p.m. EST January 26, 1967 (209 pages), and 10:00 a.m. EST January 27, 1967 (4 pages). (b) Differences existed between the ground test procedures and the inflight checklists.

Determination—Neither the revision nor the differences contributed to the accident. The late issuance of the revision, however, prevented test personnel from becoming adequately familiar with the test procedure before use.

Recommendations—(a) Test procedures and pilot's checklists that represent the actual CM configuration should be published in final form and reviewed early enough to permit adequate preparation and participation of all test organizations. (b) Timely distribution of test procedures and major changes should be made a constraint to the beginning of any test.

8. *Finding*—The fire in CM 012 was subsequently simulated closely by a test fire in a full-scale mockup.

Determination—Full-scale mockup fire tests could be used to give a realistic appraisal of fire risks in flight-configured spacecraft.

Recommendation—Full-scale mockups in flight configuration should be tested to determine the risk of fire.

9. *Finding*—The CM environmental control system design provided a pure oxygen atmosphere.

Determination—This atmosphere presented severe fire hazards if the amount and location of combustibles in the CM were not restricted and controlled.

Recommendations—(a) The fire safety of the reconfigured CM should be established by full-scale mockup tests. (b) Studies of the use of a diluent gas should be continued, with particular reference to assessing the problems of gas detection and control and the risk of additional operations that would be required in the use of a two-gas atmosphere.

10. *Finding*—Deficiencies existed in CM design, workmanship and quality control, such as: (a) Components of the environmental control system installed in CM 012 had a history of many removals and of technical difficulties, including regulator failures, line failures, and environmental control unit failures. The design and installation features of the environmental control unit made removal or repair difficult. (b) Coolant leakage at solder joints had been a chronic problem. (c) The coolant was both corrosive and combustible. (d) Deficiencies in design, manufacture, installation, rework, and quality control existed in the electrical wiring. (e) No vibration test was made of a complete flight-configured spacecraft. (f) Spacecraft design and operating procedures required the disconnecting of electrical connections while powered. (g) No design features for fire protection were incorporated.

Determination—These deficiencies created an unnecessarily hazardous condition and their continuation would imperil any future Apollo operations.

1967

April

Recommendations—(a) All elements, components, and assemblies of the environmental control system should be reviewed in depth to ensure its functional and structural integrity and to minimize its contribution to fire risk. (b) The design of soldered joints in the plumbing should be modified to increase integrity or the joints should be replaced with a more structurally reliable configuration. (c) Deleterious effects of coolant leakage and spillage should be eliminated. (d) Specifications should be reviewed; three-dimensional jigs should be used in manufacture of wire bundles; and rigid inspection at all stages of wiring design, manufacture, and installation should be enforced. (e) Flight-configured spacecraft should be vibration-tested. (f) The necessity for electrical connections or disconnections with power on within the crew compartment should be eliminated. (f) The most effective means of controlling and extinguishing a spacecraft fire should be investigated. Auxiliary breathing oxygen and crew protection from smoke and toxic fumes should be provided.

11. *Finding*—An examination of operating practices showed the following examples of problem areas: (a) The number of open items at the time of shipment of the CM 012 was not known. There were 113 significant engineering orders not accomplished at the time CM 012 was delivered to NASA; 623 engineering orders were released subsequent to delivery. Of these, 22 were recent releases that were not recorded in configuration records at the time of the accident. (b) Established requirements were not followed with regard to the pretest constraints list. The list was not completed and signed by designated contractor and NASA personnel before the test, even though oral agreement to proceed was reached. (c) Formulation of and changes in prelaunch test requirements for the Apollo spacecraft program were responsive to changing conditions. (d) Noncertified equipment items were installed in the CM at time of test. (e) Discrepancies existed between NAA and NASA MSC specifications regarding inclusion and positioning of flammable materials. (f) The test specification was released August 1966 and was not updated to include accumulated changes from release date to the January 27 test date.

Determination—Problems of program management and relations between Centers and with the contractor had led to some insufficient responses to changing program requirements.

Recommendation—Every effort must be made to ensure the maximum clarification and understanding of the responsibilities of all organizations in the program, the objective being a fully coordinated and efficient program.

Report of Apollo 204 Review Board to the Administrator, National Aeronautics and Space Administration, April 5, 1967, transmittal letter and pp. 6-1 through 6-3; House Committee on Science and Astronautics, Subcommittee on NASA Oversight, *Investigation into Apollo 204 Accident: Hearings*, 90th Cong., 1st sess., vols. 1-3, April 10, 11, 17, 21, May 10, 1967; Senate Committee on Aeronautical and Space Sciences, *Apollo Accident: Hearings*, 90th Cong., 1st sess., pts. 3-7, April 11, 13, and 17, May 4 and 9, 1967.

PART II

Recovery, Spacecraft Redefinition, and First Manned Apollo Flight

April 6, 1967, through October 22, 1968

PART II

The Key Events

1967

- April 6:* A program of biology training for lunar mission crews was formulated.
- April 10:* MSC's ASPO Manager George M. Low established two task teams to investigate CSM electrical systems and flammable materials.
- April 27:* NASA Task Team—Block II CSM Redefinition was established in residence at North American Aviation to provide timely decisions during spacecraft redefinition following the January 27 AS-204 fire.
- May 1:* NASA estimated that the impact of the AS-204 accident on program costs for FY 1967 and 1968 would be \$81 million.
- May 18:* Crew members for the Apollo 7 (first manned Apollo flight) were named: Walter M. Schirra, Jr., Donn F. Eisele, and R. Walter Cunningham.
- June 1:* A meeting at MSC discussed CSM and LM changes, schedules, and related test and hardware programs.
- August 1:* *Lunar Orbiter V* was launched; five potential Apollo landing sites were photographed during mission.
- August 18:* The NASA Block II CSM Redefinition Task Team, established April 27, was phased out.
- September 6:* An Apollo System Safety program was established by NASA Hq.
- October 5:* An Apollo Spacecraft Incident Investigation and Reporting Panel was established at MSC.
- October 24–November 3:* Eberhard F. M. Rees made a preliminary survey at North American Rockwell before forming an Apollo Special Task Team to support MSC on manufacturing problems.
- November 4:* NASA announced an Apollo mission schedule for six flights in 1968 and five in 1969.
- November 9:* The *Apollo 4* mission was successfully flown. The spacecraft landed in the Pacific Ocean after an 8-hour 37-minute flight.
- December 16:* NASA and North American Rockwell personnel reached decisions on flammability problems related to coax cables in CSMs.
- December 17:* A LM test failed at Grumman when a window shattered during the initial pressurization test of the LM-5 ascent stage.
- December 25:* The first fire-in-the-hole test was successfully completed at White Sands Test Facility. The vehicle test configuration was LM-2.

1968

- January 2:* The Associate Administrator for Manned Space Flight summarized key decisions required to certify the Apollo system design for manned flight.
- January 17:* Eberhard Rees, Director of the Apollo Special Task Team at North American Rockwell, Downey, told ASPO Manager George M. Low he had found "serious quality and reliability resources deficiencies."
- January 22:* NASA launched *Apollo 5*, the first LM flight (unmanned). The AS-204 launch vehicle was used.
- January 24:* CSM Manager Kenneth S. Kleinknecht listed what he thought were the chief problems facing the program.
- February 5:* The Senior Flammability Board decided on action to prepare for a 60-percent oxygen/40 percent nitrogen prelaunch atmosphere in CSM 101.
- February 28:* Priorities for scientific objectives vs mission operations for the first lunar landing mission were established.

PART II: RECOVERY, REDEFINITION, AND FIRST FLIGHT

- April 4:* *Apollo 6* was launched on a Saturn V booster, with an unmanned Block I CSM and a lunar test article. The spacecraft landed in the Pacific Ocean in good condition.
- April 5-7:* A 48-hour delayed-recovery test was successfully conducted in the Gulf of Mexico with three astronauts in CSM 007.
- April 10:* The Apollo Program Director said a TV camera would be carried in CM 101 (*Apollo 7*).
- May 6:* Lunar landing research vehicle No. 1 crashed at Ellington AFB, Tex., during a training flight. Astronaut Neil A. Armstrong ejected and suffered minor injuries. The vehicle was a total loss.
- May 28:* The LM ascent engine problem was resolved, with North American Rockwell's Rocketdyne Division responsible for delivery. The engines would be furnished by Bell Aerosystems Co. to Rocketdyne, and the Rocketdyne injector installed in the engine.
- July 3:* The final drop test to qualify the CSM earth landing system was successfully conducted.
- August 9:* ASPO Manager George M. Low initiated a series of actions that resulted in the ultimate decision several months later to send *Apollo 8* on a lunar-orbit mission.
- August 30:* The Director of the Apollo Special Task Team at North American Rockwell, notified the contractor that the facilities there were relinquished to the company. The team's mission was ended.
- September 23:* The Apollo Guidance Software Task Force submitted its final report.
- October 11:* *Apollo 7* was successfully launched from Kennedy Space Center on a Saturn IB launch vehicle. The first manned Apollo flight was completed October 22.

PART II

Recovery, Spacecraft Redefinition, and First Manned Apollo Flight

April 6, 1967, through October 22, 1968

A program of biology training for lunar mission crews was formulated as part of a comprehensive Block II Training Plan being reviewed by the Flight Crew Operations Directorate at MSC. The program was to provide flight crews with rudimentary facts about microbial life forms, an understanding of the bioscientific importance of lunar exploration, and training in collection of lunar samples (biological requirements) and the various aspects of the quarantine program. The biology training was to be divided into five lecture and demonstration sessions, with one field trip to observe desert ecology.

Memo, Director of Flight Crew Operations to Special Assistant to the Director, "Bioscience training of lunar mission crews," April 6, 1967.

Joseph F. Shea, MSC Apollo Spacecraft Program Office Manager, was appointed NASA Deputy Associate Administrator for Manned Space Flight, with responsibility for technical aspects of the program.

George M. Low, MSC Deputy Director, would succeed Shea as ASPO Manager. Changes were to be effective April 10.

MSC Announcement 67-51, "Key Personnel Change," April 7, 1967.

A flash report sent to the NASA Apollo Program Director by ASPO Manager George M. Low at MSC informed him that all the fuel-cell gaseous-nitrogen titanium-alloy tanks were suspected of having contaminated welds. The problem was detected during an acceptance test. Preliminary investigation revealed the weld had become contaminated during girth weld repair, because of incomplete purging of the tank's interior. All rewelded tanks were therefore liable to be contaminated and records were inadequate to identify which tanks had been rewelded. The following actions had been directed by Low for use on spacecraft 017 and 020: (1) cyclic and proof pressure test at pressures well above normal operating followed by x-ray and dye penetrant inspection on replacement tanks for spacecraft 017 fuel cells;

1967

April

6

7

8

1967
April and (2) removal of the spacecraft 017 tanks and replacement with tanks subjected to (1) above was planned. It was expected that this could be accomplished without removal of the fuel cells, and the replacement of the three tanks was not expected to affect the 017 schedule.

TWX, Low to NASA Hq., April 8, 1967.

8 MSC Structures and Mechanics Division Chief Joseph N. Kotanchik had strongly recommended that all B-nuts already installed in spacecraft be loosened to relieve any residual strain on nearby solder joints, ASPO Manager George M. Low informed CSM Manager Kenneth S. Kleinknecht. Kotanchik thought the leaks found in spacecraft 012 at KSC and in spacecraft 101 during test were most likely caused by creep. Loosening all joints, replacing them with voishan washers, and then retorquing them with procedures known not to cause strain, should be given serious consideration. Low pointed out this would also accomplish Kleinknecht's desires of being sure that all joints were torqued to proper limits.

Memo, Low to Kleinknecht, "Creep of solder joints," April 8, 1967.

10 MSC informed NASA Hq. that the spacecraft 017 inertial measurement unit (IMU) was being removed to replace capacitors that were suspect after a number of failures with qualified mylar capacitors. Replacement was expected to delay mechanical mating of the spacecraft and launch vehicle an estimated two days. The guidance and navigation subsystem would be retested during the integrated spacecraft system tests with the launch vehicle simulator. Headquarters was also advised that all other IMUs in the program had been retrofitted to eliminate the suspect capacitor. Five days later, CSM Manager Kenneth Kleinknecht told KSC that MSC understood that the original impact had been increased to five days, but asserted the change was still mandatory.

TWXs, George M. Low, MSC, to S. C. Phillips, NASA OMSF, April 10, 1967; Kleinknecht, MSC, to KSC, April 15, 1967.

10 MSC ASPO Manager George M. Low told Sydney C. Jones, Jr., MSC Communications and Power Branch, that he wanted to establish two task teams on CSM electrical systems. The first team would study the wiring harnesses on spacecraft 2TV-1 and 101 and all subsequent spacecraft to determine actions needed to save the harnesses as installed. Low asked: "Can a sufficient number of nylon wire bundle ties be replaced to meet the requirements of our new materials specification? Can silicone rubber padding and chafing guards be replaced? What fixes must be incorporated to meet requirements of the recent inspection activities? Has the harness been mistreated in recent months, as was mentioned to me by some of the astronauts? How about water glycol spillage in 101?" The task team was to include members from the Engineering and Development and Flight Crew Operations Directorates, the Flight Safety Office, and the Reliability, Quality, and Test Division. Low asked firm recommendations concerning the harnesses in spacecraft 2TV-1 and 101 by April 15 if possible.

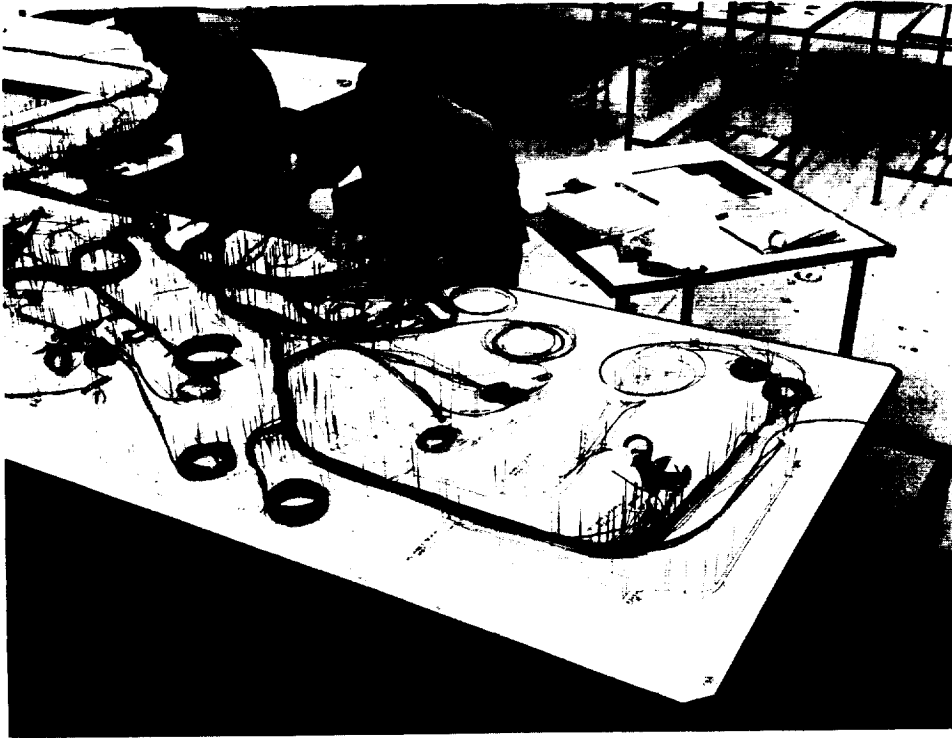

North American manufacturing personnel route electrical wires on a jig board as they prepare the CM 107 crew compartment wiring harness.

The second task team would study flammable materials used with all other electrical systems. Low referred "specifically to the RTV [room temperature vulcanizing] used on the backs of circuit-breaker panels and elsewhere; the circuit breakers themselves; the electroluminescent panels; and any other materials generally associated with the electrical system." Low said Structures and Mechanics Division (SMD) had done some very promising work with coatings for the circuit-breaker panels but these coatings might not be applied to some of the panels because of the open mechanical elements of many of the switches. He recommended that Jones ask representatives from SMD, the Instrumentation and Electronics Systems Division, and the Flight Safety Office to work with him. Low asked Jones to let him know by April 12 when it would be possible to make specific recommendations as to what needed to be done.

Memo, Low to Jones, "Task Team assignments," April 10, 1967.

George Low requested William M. Bland, MSC, to take action on two recommendations made by MSC Director Robert R. Gilruth: (1) Take stereo color photos of all spacecraft areas before they were closed out. This procedure had been invaluable during the Apollo Review Board's activities

1967

April

10

- 1967**
April at KSC, and the same technique, applied during the manufacturing process of current spacecraft, might help answer questions raised subsequent to the closeout of an area and thereby save time. (2) Make additional requirements for the use of cover plates over spacecraft wire bundles. Greater use of cover plates during manufacturing, test, and perhaps even flight would prevent damage during subsequent activities.

Memo, Low to Bland, "Stereo photographs of spacecraft activities," April 10, 1967.

- 10** An investigation at Grumman compared flammability characteristics of blankets representative of the external LM vehicle insulation with those of unshielded mylar blankets. When subjected to identical ignition sources, the mylar specimens burned during all phases of testing. Localized charring and perforation were the only visible signs of degradation in specimens simulating the LM shielding. The conclusion was that the protection of mylar blankets by H-Film in the LM configuration effectively decreased the likelihood of ignition from open flame or electrical arcing.

LM Engineering Memo, LMO-562-11, to addressees from B. Bell, "Flammability Characteristics of LM Thermal Shielding," April 10, 1967; ltr., E. Stern to MSC, Attn: R. Wayne Young, "Contract NAS 9-1100, Flammability Characteristics of LM Thermal Shielding," April 17, 1967.

- 14** NASA Hq. informed the Directors of the manned space flight Centers that responsibility for approval of pressure vessel tests was being returned to normal Center management channels. Because of the failure of the 503 launch vehicle S-IVB stage and other pressure vessel problems, testing had been restricted by the office of the Apollo Program Director. The Program Director now returned to the Center Directors "responsibility for approving pressurization tests of pressure vessels in spacecraft modules, launch vehicle stages, and ground support equipment within their Apollo program responsibilities."

TWX, Apollo Program Director to Center Directors, "Responsibility for Approval of Tests and Pressure Vessels," April 14, 1967.

- 14** CM mockup tests by the Structures and Mechanics Division at the MSC Thermochemical Test Area had shown that significant burning occurred in oxygen environments at a pressure of 11.4 newtons per square centimeter (16.5 psia). The tests, in which most of the major crew bay materials had been replaced by Teflon or Beta cloth, consisted of deliberately igniting crew bay materials sequentially in two places. The Division recommended that operation with oxygen at 11.4 newtons in the crew compartment be eliminated and that either air or oxygen at 3.5 newtons per sq cm (5 psia) be used. In reply, the ASPO Manager pointed out that "Dr. Gilruth has indicated a strong desire to avoid the use of air on the pad which requires subsequent spacecraft purges. Accordingly, we should maintain the option

of launching with a pure oxygen cabin environment until such time as additional tests indicate it would not be feasible."

1967

April

Memos, Chief, MSC Structures and Mechanics Div., to Manager, ASPO, "Use of 16.5 psia oxygen as a cabin environment," April 14, 1967; Manager, ASPO, to Joseph N. Kotanchik, "Command and Service Module environment at launch," April 18, 1967.

A meeting at MSC considered requirements of the Apollo flight program before the first lunar landing mission. Present were C. H. Perrine, MSC Mission Operations Division, and Christopher C. Kraft, Jr., Sigurd A. Sjoberg, John D. Hodge, Eugene F. Kranz, Morris V. Jenkins, and Robert E. Ernull, all of Flight Operations Directorate. Most significant opinions resulting from the meeting were:

17

- Demonstrations of extravehicular transfer and CSM rescue of LM were not considered prerequisite to manned LM earth-orbital operations separated from the CSM.

- A rendezvous exercise on Apollo 7 (CSM 101) with a "pod" would be worth attempting some time after the first day of the mission.

- Unmanned burns of the LM ascent and descent propulsions systems, including fire-in-the-hole burns, were considered prerequisites to manning those functions. This prerequisite included manning of descent propulsion system burns.

- Three manned earth-orbital flights of the CSM and LM in joint operations, plus a single CSM-alone flight, were considered the minimum number of missions in the primary program before the first potential lunar mission.

- Although a lunar orbit mission should not be a step in the primary program, it should be part of the contingency plan in the event the CSM achieved lunar-mission capability before the LM did. The gains in operational experience were considered sufficient to justify the risk of such a mission.

- Saturn V launch vehicles should be manned (i.e., should launch manned spacecraft) as soon as possible.

- There was some question about the "manability" of LM-2.

Memo for File, Perrine, "Meeting with FOD on Apollo Flight Program," April 17, 1967.

ASPO Manager George M. Low pointed out to MSC Director of Engineering and Development Maxime A. Faget that apparently no single person at MSC was responsible for spacecraft wiring. Low said he would like to discuss naming a subsystem manager to follow this general area, including not only the wiring schematics, circuitry, circuit-breaker protection, etc., but also the detailed design, engineering, fabrication, and installation of wiring harnesses.

18

Memo, Low to Faget, "Subsystem manager for spacecraft wiring," April 18, 1967.

NASA Apollo Program Director Samuel C. Phillips signed a directive defining the requirements, responsibilities, and inter-Center coordination

18

1967
April necessary for development, control, and execution of test and checkout plans and procedures for preparing and launching Apollo-Saturn space vehicles at KSC.

Memo, Chief, Apollo Program Planning, NASA OMSF, to distr., "Apollo Weekly Status Report," April 21, 1967.

20-26 A fire broke out in the Bell Aerosystems Test Facility, Wheatfield, N.Y., at 2:30 a.m. April 20. Early analysis indicated the fire was started by overpressurization of the ascent engine's propellant-conditioning system, which caused the system relief valve to dump propellant into an overflow bucket. The bucket in turn overflowed and propellant spilled onto the floor, coming into contact with a highly oxidized steel grating. Contact was believed to have initiated combustion and subsequently an intense, short-duration fire. The fire began in the test facility building near the altitude chamber and fuel tanks and spread to the inside of the altitude chamber. Among the effects of the fire on the program were (1) about four weeks' requirement to repair the LM ascent engine test facility, (2) tests delayed accordingly, and (3) delay of the acceptance test of the LM-2 ascent engine.

On April 26, a small localized fire occurred in Test Cell No. 3G at the Bell Aerosystems Test Center in Porter, N.Y. Preliminary reports indicated that a LM ascent engine bipropellant valve had been tested as a valve injector assembly but was not connected to an injector at the time of the fire. This valve was being purged with nitrogen on the fuel side and water on the oxidizer side in preparation for flushing. A very small quantity of fuel had spilled from the valve during hookup to the flush stand. When the water started to flush through the oxidizer side, a loose connector allowed oxidizer to come in contact with the spilled fuel and the fire resulted. No one was injured; damage was estimated at \$250.

ASPO Manager George Low received a message from NASA Hq. May 3 expressing concern that the two fires within one week might be symptomatic of inadequate test procedures and personnel training, which could lead to a more serious accident. Headquarters requested results of the investigations and notice of corrective action taken to prevent future incidents.

TWXs, Low to NASA Hq., Attn: Apollo Program Director, April 26, 1967; NASA Hq. to Low, May 3, 1967.

21 NASA Associate Administrator for Manned Space Flight George E. Mueller instructed NASA Apollo Program Director Samuel C. Phillips, MSC Director Robert R. Gilruth, and KSC Director Kurt H. Debus to review all findings and recommendations of the Apollo 204 Review Board and assign responsibility to an appropriate person for (a) program office evaluation of the findings and recommendations, (b) the action to be taken on each finding or recommendation, (c) the date on which this action was to be completed, and (d) the preparation of a report closing out the accident.

Upon completion of items (a) and (b) above, the responsible subsystem or system manager was to review his evaluation and planned actions with the Chairman of the Board panel responsible for determining the findings and recommendations, to be sure that they had been properly interpreted. Appropriate certification of facts would be signed by the panel Chairman.

1967

April

Mueller specified that "Review Boards at the two Centers, either assisting or set up for this review, should review the above actions with respect to the findings and recommendations of the 204 Review Board; and to each other to be sure that we have a consistent and adequate approach to the problems and that the statement of actions and the actions themselves are feasible, and are clearly enough expressed so as to be unambiguous in content."

The above actions were to be completed by April 28 and reported to NASA Hq. in a form that could be presented to Congress. (See May 9-10 entry.)

Memo, Mueller to Phillips, Gilruth, and Debus, April 21, 1967.

Samuel C. Phillips, NASA Apollo Program Director, formed a task group under the direction of Harold Russell of NASA Hq. to begin preparation of a detailed inspection standards publication.

25

The task force would use pictures and discrepancy reports, the Apollo 204 Review Board report, and special inspections of spacecraft 012, 014, 017, 020, and 101 and LM-1.

During preparation of the uniform set of manned space flight standards, the quality control and inspection standards Centers had previously imposed upon their contractors would not be changed without approval of the Apollo Program Office. Phillips estimated that the project might be completed in about a month.

TWX, Phillips to Robert R. Gilruth, MSC, Kurt H. Debus, KSC, and Wernher von Braun, MSFC, April 25, 1967.

Because of the amount of flammable material in spacecraft 017 and 020, MSC decided to purge these two spacecraft on the pad with gaseous nitrogen. The total amount of oxygen in the spacecraft at time of reentry would not exceed 14 percent. No tests would be conducted on these spacecraft with hatches closed when men were in the spacecraft.

26

TWX, ASPO Manager to NASA Hq., Attn: Apollo Program Director, April 26, 1967.

NASA Task Team—Block II Redefinition, CSM, was established by ASPO. The team—to be in residence at North American Aviation during the redefinition period—was to provide timely response to questions and inputs on detail design, overall quality and reliability, test and checkout, baseline specifications, configuration control, and schedules.

27

1967

April

Astronaut Frank Borman was named Task Team Manager and group leaders were: Design, Aaron Cohen; Quality and Reliability and Test and Checkout Procedures, Scott H. Simpkinson; Materials, Jerry W. Craig; Specifications and Configuration Control, Richard E. Lindeman; and Scheduling, Douglas R. Broome.

Memo, Manager, CSM, Apollo Spacecraft Program, to addressees, "Block II redefinition, command and service modules," April 27, 1967.

27

Astronaut Donn F. Eisele, a member of the Block II Wiring Investigating Team, wrote the ASPO Manager his reservations as to whether the wiring in spacecraft 101 could be salvaged and made safe for flight. "To render positive assurance of wiring integrity, strong consideration should be given to replacing the entire 101 harness with a new, like item—made to the same drawings as the present harness, but constructed and installed under more rigorous quality control measures; and using non-flammable materials. The replacement harness should be installed at the outset in protective trays and covers now being implemented at NAA [North American Aviation]. A wiring overlay could be installed later, to accommodate recent spacecraft design changes, if adequate space is provided in the protective trays, connector support provisions, etc. This should provide a harness of good quality and known condition to start with; and the protection and quality control measures should keep its integrity intact." (Eisele was the pilot on the Apollo 7 mission—the first manned Apollo mission and the one on which spacecraft 101 was used.)

Ltr., Eisele to ASPO Manager, "Spacecraft 101 wiring," April 27, 1967.

April 28–

May 16

Spacecraft delivery date and ground rule discussions were summarized by MSC ASPO Manager George M. Low in a letter to North American Aviation's Apollo Program Manager Dale D. Myers. Low referred to an April 23 letter from Myers and April 25 talks at Downey, Calif.

Basic was "an MSC ground rule that the first manned flight should be an open-ended mission; and that 2 TV 1 (a test spacecraft) would be a constraint on that mission. I also stated that I would like to achieve a delivery date for Spacecraft 101 that is no later than November, 1967, and that all constraining tests on 2 TV 1 should be completed one month before the flight of 101. I further stated that the proposed delivery dates for Spacecraft 103 and subsequent spacecraft were not good enough and that we should strive to achieve earlier dates.

"In summary, we did not agree with the basic ground rules stated in your April 23, 1967, letter. These ground rules essentially implied that 101 was to be limited to a six-orbit mission, and to be delivered as early as possible at the expense of all other spacecraft. Instead, we stated that it is NASA's position to achieve a balanced program involving the earliest possible deliveries when all spacecraft are considered and not just the first one."

A further exchange of letters May 8 and 16 reached agreement on target delivery dates and ground rules. Testing of thermal vacuum test vehicle 2TV-1 would be as originally planned except that extravehicular activities would not be included in tests constraining CSM 101. Delivery date was to be October 14. CSM 101 was to be delivered December 8 and would be launched on a Saturn IB to verify system performance. The mission was to be open-ended, up to 10 days, with no LM and no docking or EVA provisions included. New delivery date for CSM 103 was March 23, 1968.

1967

April

Ltrs., Low to Myers, April 28 and May 8, 1967; Myers to Low, May 16, 1967.

MSC estimated the effect of the Apollo 204 fire on program costs for FY 1967 and 1968, in reply to April 26 instructions from NASA Apollo Program Manager Samuel C. Phillips. Estimates were:

May

1

Command and service modules	\$25 million
Lunar module	21 million
Other	<u>35 million</u>
Total	\$81 million

Further, the program extension resulting from the accident would require an additional budget allocation during FY 1969 and continuing through program runout. A May 4 message from MSC confirmed the information telephoned to Headquarters May 1.

The following ground rules had been used in estimating the cost impact:

- All changes planned as of May 1 for the command and service modules and the lunar module were included.
- Vehicle delivery dates were as of April 29. Guidance and navigation schedules were adjusted to support revised CSM and LM need dates.

TWXs, NASA Hq. to MSC, "Cost Impact of 204 Accident," April 26, 1967; MSC to NASA Hq., "Cost Impact of the 204 Accident," May 4, 1967.

The Space and Information Systems Division of North American Aviation, Inc., was renamed Space Division, effective May 1.

1

TWX, North American Aviation Space Div., Downey, Calif., to NASA Hq., MSFC, MSC, and KSC, "Redesignation of S&ID as Space Division," May 9, 1967.

George C. White, Jr., NASA OMSF Director of Apollo Reliability and Quality, told Apollo Program Director Samuel C. Phillips that an MSC presentation on April 29 had restored confidence in Apollo's future, but three areas caused him concern as possible compromises with crew safety and mission success in the interest of near-term schedule and cost considerations. They were:

1

- Soldered joints in coolant system plumbing. Design of the joints was basically wrong; the insertion of the tubing into the sleeve was less than the tube diameter. Shear strength of the solder had to be depended upon for

1967

May

mechanical integrity against bending and vibration as well as for sealing. Insertion should be two to three times the diameter so that bending could be carried by the bearing of the tube in the sleeve, and the solder would only have to seal.

- Wiring harnesses. Wiring in the Block II spacecraft had a number of problems, the real significance of which was difficult to evaluate. Numerous instances of damaged insulation (bare conductor) had been found and the repairs had, in turn, resulted in more damage. At least once, split insulation (bare conductor) had been found inside a wire bundle; it could have been in the wire as received or could have resulted from cold flow.

- Modification procedure. MSC planned to make the changes in the Block II spacecraft by working directly from mockup to the spacecraft, using sketches and a minimum of paper work. While this kind of an operation could get a job done in a hurry, it required a strong leader, thoroughly experienced in working with engineering and factory people and procedures, and rigorous adherence to a minimal streamlined paper system. All "engineering" must be on drawings and all fabrication work must be inspected at least as rigorously as in a normal manufacturing process.

White urged close management attention to ensure quality.

Memo, White to Phillips, "MSC plan presented on April 29, 1967," May 1, 1967.

2

The Air Force Manned Orbiting Laboratory Systems Program Office requested that MSC present a briefing to selected office and contractor personnel on NASA's progress in safety studies and tests associated with fire hazards aboard manned space vehicles. Information was requested for the MOL program to help formulate studies and activities that would not duplicate MSC efforts. The briefing was given at MSC May 10.

TWXs, MOL Systems Program Office, Los Angeles, to MSC, "Request for Briefing on Safety Studies and Associated Tests," May 2, 1967; MSC to Space Systems Div., USAF, May 3, 1967.

2

ASPO Manager George M. Low asked the Chairman of the Apollo 204 Review Board to consider releasing CM 014 for use in the Apollo program. If the Review Board had a continuing need for the CM, Low requested that consideration be given to release of certain individual items needed for the Apollo Mission Simulator program. Board Chairman Floyd L. Thompson notified Low on June 22 that the CM mockup and CM 014 were no longer required by the Review Board and that their disposition might be determined by the ASPO Manager.

Memo, Low to Chairman, Apollo 204 Review Board, "Release of Command Module 014," May 2, 1967; TWX, Thompson to MSC, Attn: George M. Low, June 22, 1967.

2-4

NASA Block II Redefinition Task Team group leaders and CSM Program Manager Kenneth S. Kleinknecht arrived at North American Aviation Space Division at Downey May 2, followed by Task Team Manager Frank Borman the next day. Borman met with North American management May 4 to

1967

May

ensure understanding of the team plan and objectives. An afternoon meeting with NASA and North American Task Managers and group leaders reviewed the status of the Block II Redefinition task.

Following is a summation of the technical status at the time:

1. Ninety-five percent of the wires and break points had been defined, including additional wires for changes (approximately 200) plus the existing open items on spacecraft 101. Schematics for manufacturing and preparation of integrated schematics were to be available May 30.

2. AiResearch environmental control system components had been reviewed by North American and direction transmitted for materials changes.

3. North American was planning no compartment closeouts behind the front panels. This was unacceptable to NASA and closeouts would be required.

4. North American definition and review of all spacecraft materials applications were in progress, but Borman reported the progress was too slow to date and that a plan for expediting was under consideration.

5. Fire extinguisher interfaces had not yet been identified. A meeting was planned during the next week to resolve the problem.

6. NASA reaffirmed to North American the intention that DITMCO (an inspection process) of the completed installed harness be performed as late as possible and that harness protection be reinstalled immediately after DITMCO. Connectors which could not be DITMCOed must be reviewed with NASA, connector by connector.

7. NASA reaffirmed that a crew compartment fit and function test was required on each spacecraft at Downey.

8. Two meetings had been held on the Downey spacecraft 101 test and checkout. Definition of requirements was progressing rapidly and was expected to be completed and signed off by May 5. A schedule would be prepared for distribution on May 9, for the preparation, review and final approval of the operational checkout procedures necessary for the approved test requirement. The launch site test plan for spacecraft 101 would be discussed in a meeting at Downey May 9, and this meeting would be followed by a discussion of spacecraft 2TV-1 Downey test requirements as related to the Houston tests for the spacecraft 101 mission.

9. The Test Group of the Task Team planned to work closely with the Checkout Working Group and would be represented in its next meeting in Downey on May 11.

10. Rework resulting from the wiring inspection of spacecraft 101 was not proceeding as rapidly as desired; however, Borman reported that more efficient procedures were being prepared and would be carried out as soon as possible.

11. The Apollo spacecraft quality requirements were being reviewed and the North American Quality Plan would be checked against these requirements in detail.

1967**May**

Borman reported on plans and schedules:

1. A documentation center was being established to provide configuration documentation to the North American and NASA teams. A master change status board would be maintained in the NASA Task Team Office, and Block II specifications would be updated to provide the predesign baseline.

2. North American had released Master Development Schedule-10 ahead of its May 12 schedule, and detailed engineering, manufacturing, and Apollo test operation schedules were being prepared.

Critical open items were: (1) TV monitor requirements and interfaces, (2) flashing beacon mechanization and requirements, (3) material for the lithium hydroxide canister, (4) emergency oxygen mask mechanization, (5) water chlorination mechanization, (6) rapid repressurization-mechanization or surge tank, and (7) cabin recirculation valve requirement.

TWX, RASPO at Downey, Calif., to distr., "Block II Redefinition Daily Report No. 1, dated May 4, 1967," May 5, 1967.

- 3 NASA's Space Science Steering Committee approved establishment of a facility on the moon consisting of arrays of solid corner reflectors. The first array was to be established by the earliest possible lunar landing mission, with other arrays to be carried on subsequent missions. Until the Committee and Manned Space Flight Experiment Board agreed on assignment of priorities among the various lunar science experiments, this experiment was to be considered a contingency experiment to be carried on a "space available" basis. The facility on the moon would be available to the principal investigator—C. O. Alley, University of Maryland—as well as to other scientists.

TWX, NASA Hq. to MSC, Attn: Robert Piland, May 3, 1967.

- 4 Directions had been prepared to designate mission AS-501 formally as Apollo 4, AS-204/LM-1 as Apollo 5, and AS-502 as Apollo 6, NASA Apollo Program Director Samuel C. Phillips informed Associate Administrator for Manned Space Flight George E. Mueller. Phillips said he thought it was the right time to start using the designations in official releases and appropriate internal documentation. Mueller concurred.

Note, Phillips to Mueller, May 4, 1967.

- 5 Circuit breakers being used in both CSM and LM were flammable, MSC ASPO Manager George Low told Engineering and Development Director Maxime A. Faget. Low said that although Structures and Mechanics Division was developing a coating to be applied to the circuit breakers, such a solution was not the best for the long run. He requested that the Instrumentation and Electronics Systems Division find replacement circuit breakers for Apollo—ideally, circuit breakers that would not burn and that would fit within the same volume as the existing ones, permitting

replacement in panels already built. On July 12 Low wrote Faget again: "In light of the work that has gone on since my May 5, 1967, memo, are you now prepared to propose the use of metal-jacketed circuit breakers for Apollo spacecraft? If the answer is affirmative, then we should get specific direction to our contractors immediately. Also, have you surveyed the industry to see whether a replacement circuit breaker is available or will be available in the future?" Low requested an early reply.

1967

May

Memos, Low to Faget, "Apollo circuit breakers," May 5, 1967; "Apollo circuit breakers, continued," July 12, 1967.

After review of operational considerations for a minimum restart capability in the Saturn launch vehicle's S-IVB stage, MSC's Director of Flight Operations reported to NASA Hq. that an 80-minute restart capability was believed the best compromise for the early lunar missions, "for the primary reason of providing sufficient time for ground support in verifying navigation, and flight crew checkout of CSM and S-IVB systems prior to TLI [translunar injection], while providing for two injection opportunities in both the Atlantic and Pacific Oceans (second and third revolutions). For later missions, consideration should be given to the hardware implications of providing a restart capability with minimum (zero) restrictions, so that advantage may be taken of confidence in onboard systems to gain additional payload."

5

Ltr., Christopher C. Kraft, Jr., MSC, to NASA Hq., "S-IVB Restart Capability," May 5, 1967.

NASA reported to Congress on actions taken on the Apollo 204 Review Board's findings and recommendations concerning the January 27 spacecraft fire. Administrator James E. Webb, Deputy Administrator Robert C. Seamans, Jr., and Associate Administrator for Manned Space Flight George E. Mueller testified before the Senate Committee on Aeronautical and Space Sciences May 9 and before the House Committee on Science and Astronautics' Subcommittee on NASA Oversight May 10. (See also September 21 and Appendix 8.)

9-10

Senate Committee on Aeronautical and Space Sciences, *Apollo Accident: Hearings*, 90th Cong., 1st sess., pts. 6-7, May 9, 1967; House Committee on Science and Astronautics, Subcommittee on NASA Oversight, *Investigation into Apollo 204 Accident: Hearings*, 90th Cong., 1st sess., vol. 3, May 10, 1967; *Astronautics and Aeronautics, 1967* (NASA SP-4008, 1968), pp. 144-148.).

MSC responded to a March 29 letter from NASA Hq. concerning two arrays of Apollo Lunar Surface Experiments Package (ALSEP) experiments. MSC said it had reviewed schedules, cost, and integration aspects of the requested configurations and that four areas of the project apparently should be modified to allow proper inclusion of the configurations: (1) extension of mission support efforts by Bendix Aerospace Systems Division (BxA) for the fourth ALSEP mission; (2) extension of KSC's support efforts by BxA for the fourth ALSEP mission; (3) extension of the ALSEP prototype test program to encompass three distinct system configurations rather than the two in the

10

1967

May

original plans; and (4) extension of the ALSEP qualification test program to encompass three distinct configurations rather than the original two. The cost impact was estimated at \$670 000, and completion of the ALSEP contract was expected to be extended three months to allow for mission support for the fourth flight.

Ltr., Robert R. Gilruth, Director, MSC, to NASA Hq., Attn: Samuel C. Phillips, "Selection of Apollo Lunar Surface Experiments Package System Configurations," May 10, 1967.

11

NASA Administrator James E. Webb issued a statement on selection of the Apollo spacecraft contractor: "In the 1961 NASA decision to negotiate with North American Aviation for the Apollo command and service modules, there were no better qualified experts in or out of NASA on whom I could rely than Dr. Robert Gilruth, Dr. Robert C. Seamans, and Dr. Hugh L. Dryden. These three were unanimous in their judgment that of the five companies submitting proposals, and of the two companies that were rated highest by the Source Evaluation Board, North American Aviation offered the greatest experience in developing high-performance manned flight systems and the lowest cost.

"In the selection of North American Aviation, the work of the Source Evaluation Board was not rejected or discarded. It was used as the basis for a more extensive and detailed examination of all pertinent factors than the Board had performed at the time its report was presented to Dr. Gilruth, Dr. Seamans, Dr. Dryden and to me.

"At that point it became the responsibility of NASA's Associate Administrator, Dr. Seamans; its Deputy Administrator, Dr. Dryden; and its Administrator, myself, to take all steps necessary to determine whether the facts then available formed an adequate basis for our selection of a contractor. We decided in the affirmative and then proceeded to select the contractor the facts indicated offered the most to the government."

NASA News Release 67-122, May 11, 1967.

12

George M. Low, Manager of the Apollo Spacecraft Program, notified NASA Hq. that Grumman was committed to a June 28 delivery for lunar module 1 (LM-1). This date included provisions for replacement of the development flight instrumentation harness with a new one. Low's assessment was that the date would be difficult to meet.

TWX, Low, MSC, to NASA Hq., Attn: Lee James, "LM-1 delivery schedule," May 12, 1967.

12

Anthony W. Wardell of the MSC Flight Safety Analysis Office wrote Apollo Manager Low that "the May 10 inspection further substantiates my previous recommendation to replace, rather than rework, the [spacecraft 101 wiring] harness. In addition to the visual evidence of wire damage noted, a book containing about 100 outstanding wire damage MRB (Material Review Board) actions was noted on a work table near the spacecraft." He did, however, list seven recommended suggestions to be followed in the event the harnesses were reworked rather than replaced. The suggestions

were passed on to CSM Manager Kenneth S. Kleinknecht by Low in a memorandum on May 13. Low requested that the suggestions be passed to North American Aviation as soon as possible, with additional suggestions from MSC Quality Control Chief Jack A. Jones, who had also inspected the harness.

1967

May

Memos, Jones to Low, "Inspection of SC-101 Wire Harness Assemblies," May 10, 1967; Wardell to Low, "Inspection of Spacecraft 101 Wiring Harnesses," May 12, 1967; Low to Kleinknecht, "Spacecraft 101 wiring," May 13, 1967.

Apollo 204 Review Board Chairman Floyd L. Thompson appointed a subcommittee to examine the final report of Panel 18 and prepare recommendations regarding its acceptability for inclusion in the Board's Report. Thompson named Maxime A. Faget, MSC, to chair the subcommittee and Frank Borman, MSC, George C. White, NASA Hq., and E. Barton Geer, LaRC, as members. Thompson asked that the subcommittee forward its recommendations at the earliest possible date and that it also review the comments of North American Aviation on the validity of the findings of the Board and its Panels.

12

TWX, Thompson to addressees, May 12, 1967.

The NASA Block II CSM Redefinition Task Team was augmented by the assignment of Gordon J. Stoops as Group Leader-Program Control, with the following functions:

15

- Liaison with North American Aviation Program Control and Contracts to expedite updating of the contract change authorizations and the issuance of timely program technical direction.
- Liaison with the ASPO CSM Project Engineering and Checkout Division and CSM Contract Engineering Branch at MSC to expedite contract change authorizations and ensure timely program technical direction.

Memo, Manager, CSM, ASPO, to distr., "Block II redefinition, command and service modules," May 15, 1967.

Prime and backup crews for Apollo 7 (spacecraft 101) were named, with the assignments effective immediately. The prime crew for the engineering-test-flight mission was to consist of Walter M. Schirra, Jr., commander; Donn F. Eisele, CM pilot; and R. Walter Cunningham, LM pilot. The backup crew was Thomas P. Stafford, commander; John W. Young, CM pilot; and Eugene A. Cernan, LM pilot. Names had been reported to the Senate Committee on Aeronautical and Space Sciences on 9 May.

18

Memo, Astronaut Office to distr., "Astronaut Technical Assignments," May 18, 1967; Senate Committee on Aeronautical and Space Sciences, *Apollo Accident: Hearings*, 90th Cong., 1st sess., pt. 6, May 9, 1967.

A Block II spacecraft vibration program was begun to provide confidence in CSM integrity and qualify the hardware interconnecting the subsystems within the spacecraft. A test at MSC was to simulate the vibration

19

- 1967**
May environment of max-q flight conditions. The test article was to be a Block II CSM. A spacecraft-LM adapter, an instrumentation unit, and an S-IVB stage forward area simulation would also be used.
- Memo, Chief, Systems Engineering Div. (MS), to Manager, ASPO, "Block II spacecraft vibration program," with encl., "Block II Spacecraft Vibration Program," May 19, 1967.
- 20** MSC notified NASA Hq. that—with the changes defined for the Block II spacecraft following the January 27 Apollo 204 fire and with CSM delivery schedules now reestablished—it was necessary to complete a contract for three additional CSMs requested in 1966. North American Aviation had responded September 15, 1966, to MSC's February 28 request for a proposal, but action on a contract had been suspended because of the AS-204 accident. NASA Hq. on June 27, 1967, authorized MSC to proceed.
- TWXs, Manager, ASPO, to NASA Hq., Attn: Samuel C. Phillips, "Authorization for procurement of three additional Block II CSM's," May 20, 1967; NASA Hq., Associate Administrator for Manned Space Flight to MSC, Attn: George Low, June 27, 1967.
- 22** MSC ASPO Manager George Low informed Grumman Senior Vice President George Titterton that he had asked North American Aviation assistance in improving access to the LM when placed inside the spacecraft-lunar module adapter (SLA). He also ordered a change request, in response to Grumman's April 18 request that MSC consider an SLA design change. Low had visited the pad at KSC Launch Complex 37, agreed action was necessary, and on May 19 asked North American's Apollo Program Manager Dale D. Myers for recommendations. Low said improved access to the LM was needed "both for rapid emergency egress and for normal servicing."
- An emergency method of cutting through the SLA structure in premarked locations with a "cookie cutter" portable handsaw device was adopted—primarily for exit in an emergency occurring after hypergolics were loaded into the LM.
- Ltrs., Titterton to MSC, Apr. 18, 1967; Low to Myers, May 19, 1967; Low to Titterton, May 22, 1967; memo, ASPO Manager to R. W. Williams, "Preparation of change request," May 22, 1967; Myers to Low, Aug. 11, 1967.
- 25** MSC submitted requirements to KSC that TV signals from cameras inside the LM and CM be monitored and recorded during manned hazardous tests, with hatch open or closed, and tests in the Vehicle Assembly Building, launch pads, and altitude chambers. A facility camera was to monitor the propellant-utilization gauging system during propellant loading. MSC specified that the field of view of the TV camera should encompass the shoulder and torso and portions of the legs of personnel at the normal flight stations in both the CM and the LM.
- Ltr., Owen G. Morris, MSC, to KSC, "Continuous Television Recording in Support of Manned Apollo Tests at KSC," May 25, 1967.
- 26** ASPO Manager George Low told Charles A. Berry, MSC Director of Medical Research and Operations, that it had been determined there was no suitable

PART II: RECOVERY, REDEFINITION, AND FIRST FLIGHT

1967

May

substitute for water glycol as a coolant and it would continue to be used in the Apollo spacecraft. Low recognized that it was "essential that the effects of any possible glycol spill be well defined and that procedures be established to avoid any hazardous conditions." He asked Berry's office to define the limits of exposure for glycol spills of varying quantities and for recommendations concerning cabin purge in the event of a spill. Low also wondered, assuming development of a smelling agent, if it would be possible to determine the concentration of water glycol by the strength of the smell in the spacecraft. Berry's office replied June 22 that it was working with Crew Systems Division to identify an odor additive for leak detection. They would begin a program to establish a safe upper limit for human exposure to ethylene glycol and had asked the National Academy of Sciences Committee on Toxicity for information. Animal exposure tests probably would be necessary; if they were needed, a test plan would be submitted before July 1.

Memos, Manager, ASPO, to Berry, "Water glycol toxicity," May 26, 1967; Berry to Low, June 22, 1967.

Views of bay 21 before and after a "Tiger Team" checked spacecraft 101.

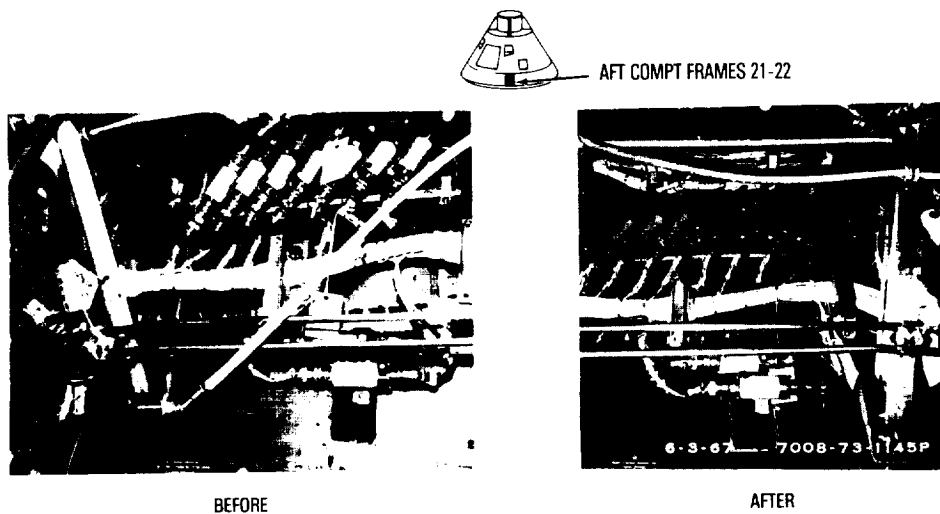

BEFORE

AFTER

REVIEWED & CORRECTED

- WIRE ROUTING & SLACK
- WIRE DAMAGE
- RELOCATED WIRE BREAKOUTS
- IMPROPER INSTALLATION OF CLAMPS

1967

May

26

NASA Headquarters and MSC officials attended a review of the CSM at North American Aviation in Downey. Following the North American briefing, the group visited the wire-harness layout and assembly areas. NASA Associate Administrator for Manned Space Flight George E. Mueller, with Anthony W. Wardell and Jack A. Jones of MSC, inspected the wiring in spacecraft 101 and 2TV-1 in detail.

Mueller stressed the importance of improving spacecraft delivery schedules, with particular emphasis on spacecraft 020 and the second and third manned spacecraft, working up to two-month delivery intervals. He was concerned about the five- to six-week spacecraft 020 hatch delay and stated that Apollo Program Director Samuel C. Phillips must approve the proposed change. North American pointed out that it was using the resources of the corporation toward the two-month delivery schedule, and that a modification task-team approach would be used as long as it was effective in improving schedules. Tiger teams of engineering, quality, manufacturing, and materials personnel were working on wiring and plumbing in spacecraft 101. CSM Manager Kenneth S. Kleinknecht reviewed the Block II Redefinition Task Team effort for Mueller and he indicated that Phillips had considered an industry tiger team to assist in the overall spacecraft effort.

Memo, Kleinknecht to ASPO Manager, "Review of command and service modules," May 26, 1967.

26

Apollo 204 Review Board Chairman Floyd L. Thompson wrote NASA Deputy Administrator Robert C. Seamans, Jr., "The Apollo 204 Review Board respectfully submits that it has fulfilled all of its duties and responsibilities as prescribed by the Deputy Administrator's memorandum of February 3, 1967. Accordingly, it is requested that the Apollo 204 Review Board be dissolved."

Ltr., Thompson to Seamans, "Report of Completion of Apollo 204 Review Board Activities," May 26, 1967.

29

W. R. Downs, Special Assistant for Advanced Systems, MSC Structures and Mechanics Division, discovered that bare or defectively insulated silver-covered copper wires exposed to glycol/water solutions would ignite spontaneously and burn in oxygen. Copper wire or nickel-covered copper wire under identical conditions did not ignite. The laboratory results were confirmed in work at the Illinois Institute of Technology. In a June 13 memorandum, the Chief of the Structures and Mechanics Division recommended that if additional testing verified that nickel-coated wires were free of the hazard, consideration should be given to an in-line substitution of nickel-coated wires for silver-coated wires in the LM. It was understood that the Block II CSM already had nickel-coated wires. In a June 20 memo to the ASPO Manager, the Director of Engineering and Development pointed out that silver-plated pins and sockets in connectors would offer the same hazards. He added that Downs had also identified a

chelating agent that would capture the silver ion and apparently prevent the reaction chain. In a July 24 memorandum, ASPO Manager George Low said that, in view of recent spills of ethylene glycol and water mixtures, spacecraft contractors North American Aviation and Grumman Aircraft Engineering had been directed to begin actions immediately to ensure that a fire hazard did not exist for the next manned spacecraft. Actions were to include identification of the location of silver or silver-covered wires and pins and of glycol spills.

1967

May

Memos, Special Assistant for Advanced Systems to Chief, Structures and Mechanics Div., "Chemical reactivity of silver covered copper wires with glycol/water solutions compared to copper or nickel covered copper wires," May 29, 1967 (rev. June 12, 1967); Chief, Structures and Mechanics Div., to Director of Engineering and Development, "Silver-covered copper wires as a fire producing hazard in spacecraft," June 13, 1967; Director of Engineering and Development to Manager, ASPO, "Silver-covered copper wires as a fire producing hazard in spacecraft," June 20, 1967; Manager, ASPO, to distr., "Silver-covered copper wires as a fire producing hazard in spacecraft," July 24, 1967.

Grumman Aircraft Engineering Corp.'s method of building wiring harness for the lunar module was acceptable, George Low, MSC Apollo Spacecraft Program Office Manager, wrote Apollo Program Manager Samuel C. Phillips at NASA Hq. Low had noted on a visit to Grumman on May 9 that many of the harnesses were being built on two-dimensional boards. In view of recent discussions of the command module wiring, Low requested Grumman to reexamine their practice and to reaffirm their position on two-versus three-dimensional wiring harnesses.

31

In his May 31 letter to Phillips, Low enclosed Grumman's reply and said that, in his opinion, Grumman's practice was acceptable because (1) most wire bundles on the LM were much thinner than the CSM wiring bundles and were much more flexible; (2) portions of the LM harness were often fabricated on a three-dimensional segment of the harness board; and (3) connectors were usually mounted on metal brackets with the proper direction and clocking.

Ltrs., Low to Phillips, May 31, 1967; J. G. Gavin to Low, "Use of Two and Three Dimensional Harness Boards in Fabrication of LM Wiring," May 24, 1967; Grumman LM Manufacturing Memo, W. B. Atchison to C. W. Rathke, "Harness Board Design—2D vs. 3D," 17 May 1967.

George M. Low told Joseph N. Kotanchik, Chief of MSC's Structures and Mechanics Division, that actions were pending on Pratt & Whitney pressure vessel failures. The pressure vessels were used in the Apollo fuel cell system. Kotanchik had spelled out a list of problem areas in connection with both the vessels and management interface between MSC and principal contractor North American Aviation, and between North American and its subcontractor Pratt & Whitney.

31

Memos, Chief, Structures and Mechanics Div., to Manager, ASPO, "Conduct of Pratt and Whitney Aircraft (PWA) on pressure vessel failure analysis," May 18, 1967; Low to Kotanchik, "Pratt & Whitney pressure vessel failures," May 31, 1967.

1967

June

1

MSC's Director of Flight Operations Christopher C. Kraft, Jr., told ASPO Manager George M. Low that his Directorate was willing to support the flight test program presented in late May and felt that the computer programs and operational support he had in development would support the flights as currently scheduled. He did offer some comments on the proposed flight test program and asked that the NASA Office of Manned Space Flight be given an indication that his suggested program was being considered as a future alternate approach. The comments included: "a. The first manned LM flight appears to be most ambitious. We believe that when the time comes, a much more conservative approach to the flight plan will be taken because of the lack of experience with the LM spacecraft. . . . b. We have the general feeling that there are insufficient flight tests scheduled in order to prove the worthiness of the LM and that a lunar landing flight could only follow a successfully completed schedule of LM flights. . . . c. We believe that a lunar orbit flight with the CSM/LM should be included in the flight test program, as an alternate to the third CSM/LM flight you have proposed, or as an additional flight to the program. . . . d. . . . we believe it feasible that one of the LM development flights could be conducted as safely in the vicinity of the moon as in earth orbit, assuming that the CSM has been proven at that time. . . . e. Finally, we believe that the lunar type flight programs we propose would have great impact on the stature of the nation's space program. . . ."

Memos, Owen E. Maynard, MSC, to Kraft, "Apollo Flight Program Definition," May 31, 1967;
Kraft to Low, "Requested comments on Apollo Flight Program Definition," June 1, 1967.

2

A meeting at MSC discussed CSM and LM changes, schedules, and related test and hardware programs. On June 26, NASA Apollo Program Manager Samuel C. Phillips summarized the discussion in a letter to George Low. He pointed out that certain problems could result in serious program impact if not solved expeditiously and specifically mentioned couch design, the weight problem in the CSM and LM, docking changes, and delivery schedules.

Minutes of Apollo Program Meeting, June 2, 1967; ltr., Phillips to Low, June 26, 1967.

6

Bendix Corp. demonstrated the operation of a sliding boom concept to prove that the Apollo Lunar Surface Experiments Package (ALSEP) could be removed from the LM at various attitudes. MSC representatives viewing the demonstration at Ann Arbor, Mich., were Aaron Cohen, Don Weissman, Paul Gerke, Don Lind, and Harrison Schmitt. Cohen reported that the mockup was crude but indicated that the concept was satisfactory to both Grumman and NASA. Design refinement, qualification, and effect on LM structure would have to be looked into. It was believed an additional seven kilograms of weight would be added to the LM descent stage. Two interface problems were defined at the meeting: (1) Bendix and Grumman required maximum and minimum attitude position for the LM to complete the design of ALSEP handling equipment. (2) Both Grumman and Bendix

required temperature criteria for the outer shield of the cask, which would contain radioactive material.

1967

June

Memo, Cohen to A. L. Liccardi, RASPO, Grumman, "Trip Report to Bendix, Ann Arbor, Michigan, on June 6, 1967," June 13, 1967.

NASA Office of Manned Space Flight had redefined the Apollo Block II manned mission flight plan, ASPO informed the MSC Director of Science and Applications. The first manned flight plan called for (1) an open-ended mission up to 10 days, (2) sufficient instrumentation, (3) no extravehicular activity, (4) a CSM rendezvous with the S-IVB stage, and (5) no experiments that required spacecraft integration. The redefinition resulted in OMSF's indicating that no scientific experiments would be flown on the mainstream Apollo flights unless they would contribute to the accomplishment of the lunar mission. ASPO therefore had told North American Aviation that certain scientific experiments planned for spacecraft 101 would now be deleted from the program. The experiments were Simple Navigation (D019), Urine Volume Measuring System (M005), UV Stellar Photography (S019), and UV/X-ray Solar Photography (S020).

7

Memo, Manager, MSC ASPO, to MSC Director of Science and Applications, "Apollo Earth Orbital Experiments," June 7, 1967.

At a NASA and North American Aviation management meeting, North American was directed to proceed with development of larger drogue parachutes and staged main chute disreefing, using 5- and 8-second reefing-line cutters. Later analysis of the system and the proposed modifications still indicated only a marginal capability to offer adequate factors of safety, and North American was directed to use 6- and 10-second reefing-line cutters. In a letter to Headquarters, MSC Director Robert R. Gilruth mentioned that a review of these modifications had been covered at the September Manned Space Flight Management Council and, since no objections were voiced at that time, MSC assumed concurrence with the changes and would implement modifications for spacecraft 101 and subsequent Block II spacecraft.

8

"Minutes of Apollo Program Meeting" (June 2, 1967); ltr., Gilruth to NASA Hq., "Command Module Earth Landing System modification," Sept. 29, 1967.

In a memorandum to the Chief, Systems Engineering Division, MSC, ASPO Manager George M. Low pointed out the weight problem in the CSM and LM was critical. Low called for a detailed review of weight effects along with any proposed design change. The weight estimate was to be submitted by the affected contractor as a part of his change proposal, and this would then be verified by the subsystems manager and Systems Engineering.

8

To provide timely weight status to the Configuration Control Board, Systems Engineering Division was given the responsibility of presenting CSM and LM weight status at each weekly Board meeting as follows: (1) control weight, (2) current weight, and (3) estimated weight at time of

1967
June

launch. These figures would be shown for three spacecraft: first manned, second manned, and lunar configuration. Both launch weight and reentry weight were to be included.

Memo, Low to Chief, Systems Engineering Div., MSC, "Spacecraft Weight," June 8, 1967.

- 8** Apollo Program Director Samuel C. Phillips, in a message to ASPO Manager George M. Low, spoke of a June 2 agreement to include a CSM active rendezvous with the Saturn S-IVB stage of the launch vehicle in the mission profile of the first manned Apollo mission. Phillips said that it should be recognized that such a rendezvous would not be a primary objective for the first manned mission and that the decision should be reviewed if any related problem that would complicate mission preparations were identified.

TWX, Phillips to Low, "First Manned Apollo Rendezvous," June 8, 1967.

- 9** Robert C. Seamans, Jr., Deputy Administrator of NASA, prepared a memorandum to the file concerning the selection of North American Aviation as the CSM prime contractor. The memorandum, a seven-page document, chronologically reviewed the steps that led to the selection of North American and followed by about a month the statement of NASA Administrator James E. Webb in response to queries from members of the Congress.

Memo to the File from Deputy Administrator, NASA, "The Selection of North American Aviation, Inc., as the prime contractor for the command and service module," June 9, 1967.

- 9** Robert O. Aller, NASA OMSF, told Apollo Program Director Samuel C. Phillips that considerable analysis, planning, and discussion had taken place at MSC on the most effective sequence of Apollo missions following the first manned flight [Apollo 7]. The current official assignments included three CSM/LM missions for CSM/LM operations, lunar simulation, and lunar capability. MSC's Flight Operations Directorate (FOD) had offered an alternate approach of that sequence by proposing that the third mission be a lunar-orbit mission rather than a high earth-orbit mission. Aller preferred the FOD proposal, since it would offer considerable operational advantages by conducting a lunar-orbital flight before the lunar landing. He recommended Phillips consider that sequence of missions and that consideration be given to including it as a prime or alternate mission in the Mission Assignments Document. "Identifying it in that document," Aller said, "would initiate the necessary detailed planning."

Memo, Aller to Phillips, "Apollo Flight Program," June 9, 1967.

- 13** The purpose of spacecraft 105 testing was to establish transition relations between the primary and secondary structure that supported systems' interconnecting hardware (wiring, tubing and associated valves, filters, regulators, etc.) and demonstrate structural integrity of the Block II CSM when subjected to qualification vibration environment, with special

emphasis on interconnecting hardware. The test vehicle was being configured with complete basic Block II wiring harness and fluid systems. The vehicle would be checked out before and after each phase of testing to verify wiring harness impedance and continuity and fluid systems pressure integrity. The fluid systems would be at operating pressure during the testing.

1967

June

Memo, ASPO Manager to Chief, Flight Safety Office, MSC, "Vibration testing," June 13, 1967.

Designations and abbreviations for flight crewmen on all manned Apollo missions were selected:

14

- Commander—CDR
- Command module pilot—CMP
- Lunar module pilot—LMP

This terminology was to be used throughout the Apollo spacecraft program and compliance was required to minimize confusion.

Memo, Manager, ASPO, to distr., "Apollo crewmen designations," June 14, 1967.

MSC Director Robert R. Gilruth told George E. Mueller, NASA OMSF, that MSC desired that the vernier engine be fired after the touchdown of Surveyor IV on the lunar surface. He reminded Mueller that this experiment was supposed to have been performed on *Surveyor III* and was of prime importance to Apollo. The fact that *Surveyor III* landed with the vernier engine firing and did not experience any significant erosion had also been of importance to the Apollo program. He requested that Surveyor IV be targeted for the Apollo landing site in the Sinus Medii area. As a lower priority experiment, Gilruth said MSC would like to get a limited amount of photography on the first lunar day, which would allow a limited assessment of viewing conditions in earthshine.

15

Ltr., Gilruth to Mueller, "Surveyor IV support of Apollo," June 15, 1967.

X-ray inspection seeks to ensure that weldments, wires, and spacecraft components are free of cracks and other damage that could jeopardize crew safety and mission success.

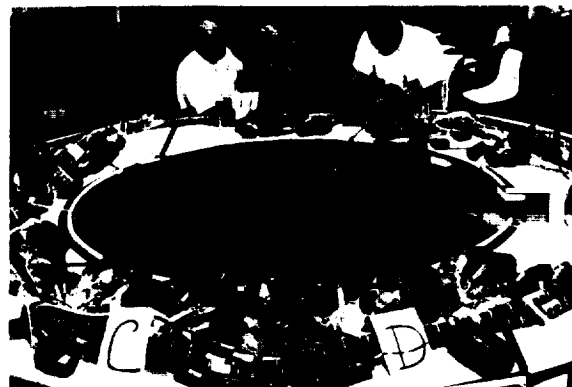

1967
June
17

Plans were to armor-plate 102 out of 167 solder joints inside the CM of spacecraft 101, ASPO Manager George M. Low informed Maxime A. Faget, MSC's Director of Engineering and Development. Of the remaining 65 joints, 53 would be accessible for armor-plating and x-raying, while the other 12 would not. Low said: "As joints become less accessible, the excess solder removal process, the joint-cleaning process, and the application of the armor-plating become more difficult. Also, in many places, the standard armor-plating sleeve does not fit, and a shorter or cutaway sleeve is required. I have therefore reached the conclusion that, at some point, the armor-plating process may become detrimental. . . . You should know that Mr. [Joseph N.] Kotanchik disagrees with this position. Joe believes that any joint in the spacecraft could be under stress and therefore is subject to creep. The only solution . . . according to Joe, is to armor-plate all joints. . . ." Low added that joints that are accessible from outside the CSM would also be armor-plated and that future spacecraft would include additional armor-plating. He said, "My expectation is that all solder joints will be armor-plated in the lunar configuration. . . ."

Memo, Low to Faget, "Armor-plating of solder joints," June 17, 1967.

19

H. G. Paul, Chief of Marshal Space Flight Center's Propulsion Division, said it had come to the attention of his office that spacecraft/S-IVB rendezvous to within approximately 100 meters was being considered for the AS-205 mission. The division's position was that, unless the S-IVB stage were made passive, the division could not guarantee the stage would be in a safe condition. After the lifetime of a nonpassivated stage, it was possible that indiscriminant propellant-tank or bottle venting could cause the stage to tumble, thus permitting liquid to enter the propellant-tank vent lines. Another area of concern was the high-pressure bottles on the stage. Should a relief valve fail to function normally, a bottle rupture could result. The Propulsion Division therefore recommended that no rendezvous mission be planned with S-IVB stages of either Saturn IB or Saturn V launch vehicles after the guaranteed lifetime of the stage, unless that stage had been passivated.

Memo, Paul to Cochairman, Guidance and Performance Subpanel, "AS-205 Spacecraft/S-IVB Rendezvous," June 19, 1967.

20

Apollo spacecraft 017 was mechanically mated to its Saturn V launch vehicle at KSC in preparation for the Apollo 4 (AS-501) unmanned mission, scheduled for the third quarter of 1967.

Astronautics and Aeronautics, 1967 (NASA SP-4008, 1968), p. 191.

20

Leonard Reiffel of the NASA Hq. Apollo Program Office suggested to Program Director Samuel C. Phillips that "we do not schedule the ALSEP [Apollo Lunar Surface Experiments Package] for the first lunar landing," because:

1967

June

- The duration on the lunar surface for the first mission was likely to be short and the ALSEP deployment time was likely to take a seriously disproportionate share of available time. "It is my opinion we will learn more of immediate consequence to science and to planning of subsequent missions from careful observations and sample collection as contrasted to emplacement of an all-up ALSEP."

- With the exception of the lunar atmosphere, manned operations would not disturb the conditions ALSEP was intended to measure. These, therefore, could be measured on later flights.

- The magnetometer was in trouble. The interpretability of plasma experiments on an ALSEP that did not include a magnetometer would be markedly depreciated.

- The problem of LM weight control would be eased substantially if only the lunar geological tools and sample boxes, rather than the full ALSEP, were carried.

20

- Waiting for the second lunar mission would decrease the risk of wasting a full ALSEP payload, since the Apollo system already would have successfully reached the moon once.

He added, "An uncrowded time line on the lunar surface for the first mission would seem to me more contributory to the advance of science than trying to do so much on the first mission that we do nothing well. . . ."

Memo, Reiffel to Phillips, "Flight Schedule for ALSEP and Related Matters," June 20, 1967.

Officials at the Manned Space Flight Management Review decided that Apollo 4 and Apollo 5 missions would be flown with no less than a 21-day interval between flights. This period was determined necessary to provide an adequate turnaround of the ground support systems to ensure proper reconfiguration, validation, and updating. The Apollo 4 mission would be given priority over Apollo 5 in the checkout and readiness phase if conflicts in use of facilities and equipment should arise.

Memo, Director, Mission Operations, NASA OMSF, to distr., "Mission Priority and Turnaround between Apollo 4 and Apollo 5," July 10, 1967.

A committee was established to conduct an operational readiness inspection (ORI) of the MSC Space Environment Simulation Laboratory. The inspection would supplement the original ORI of the facility. Emphasis would be placed on reviewing modifications since the previous inspection and upon readiness to perform the test series on LTA-8 and 2TV-1. The committee was made up of Martin L. Raines, Chairman; Rexford H. Talbert, Executive Secretary; Edward L. Hays, Alan Harter, James E. Powell, John W. Conlon, Armistead Dennett, and Joseph P. Kerwin, all of MSC; Dugald O. Black, KSC; and E. Barton Geer, LaRC.

22

Memo, Director, MSC, to distr., "Operational Readiness Inspection of the MSC Space Environmental Simulation Laboratory," June 22, 1967.

1967
June
23

Although the LM-1 wiring harness had been accepted by the Customer Acceptance Readiness Review Board it was not clear that the harness would also have been accepted for manned flight, ASPO Manager George M. Low told Apollo Systems Engineering Assistant Chief R. W. Williams. Low asked Williams to assign someone to prepare a plan of actions needed to ensure that the harnesses in LM-2 and subsequent vehicles would be acceptable.

Memo, Low to Williams, "LM spacecraft wiring and splices," June 23, 1967.

26

Apollo Program Director Samuel C. Phillips told ASPO Manager George Low he believed progress had been made toward Apollo objectives. At the same time, Phillips believed certain problems, if not solved expeditiously, could seriously delay the program. He was concerned particularly with the couch design, weight problem, docking changes, and delivery schedules. Phillips requested an early response on the problem areas.

Ltr., Phillips to Low, June 26, 1967.

26

Possible hazards to the crew in the lunar module thermal vacuum test program (using LTA-8) were pointed up in a memorandum to Manager, ASPO, and Director of Engineering and Development from the Director of Flight Crew Operations. Manning procedures required crewmen to make numerous hard vacuum transfers between the Space Environment Simulation Laboratory's environmental control system (ECS) umbilicals and the LM environmental control system hoses. Also, during the manning operations the crewmen would be on the LM-ECS with the cabin depressurized. In the configuration in use, if one of the crewmen lost his suit integrity, there would be no protection for the other man. Because of these hazardous conditions the following actions were requested: (a) provide equipment to make vacuum transfers of oxygen hoses acceptably safe; and (b) change the LTA-8 vehicle ECS so that one crewman was protected if the other lost suit integrity in a vacuum ambient.

Memo, Director of Flight Crew Operations to Manager, ASPO, and Director of Engineering and Development, "Possible hazards to the crew during the Lunar Module Thermal Vacuum Tests in Chamber B," June 26, 1967.

28

The Apollo Program Director requested MSC to assign the following experiments to AS-205, spacecraft 101: M006—Bone Demineralization, M011—Cytogenic Blood Studies, M023—Lower Body Negative Pressure, S005—Synoptic Terrain Photography, and S006—Synoptic Weather Photography. Experiment D008, Radiation in Spacecraft, would be included in the above list at the option of ASPO. On July 21 ASPO Manager George M. Low informed CSM Manager Kenneth S. Kleinknecht that he was approving reinstatement of Experiments S005 and S006 on AS-205. On the same date Low informed the Apollo Program Director that S005 and S006 would be carried on AS-205. He proposed that experiments M006, M011, and M023, which required pre- and postflight operations with the

crew, be classified not as experiments but as part of the normal pre- and postflight medical evaluation. Experiment D008 was deleted from AS-205 and all other inflight experiments previously assigned had been deleted from the spacecraft. MSC's Director of Medical Research and Operations Charles A. Berry and Director of Space Science and Applications Wilmot N. Hess concurred with Low's decision.

1967

June

Ltrs., Apollo Program Director to MSC, Attn: George M. Low, "Earth Orbital Experiment Assignments," June 28, 1967; Low to NASA Hq., Attn: Samuel C. Phillips, "Earth Orbital Experiment Assignments," July 21, 1967; memo, Manager, ASPO, to K. S. Kleinknecht, "Experiments S005 and S006," July 21, 1967.

Dale D. Myers, Apollo CSM Manager for North American Aviation, Inc., requested a meeting with ASPO Manager George M. Low and ASPO CSM Manager Kenneth S. Kleinknecht to resolve issues concerning materials replacement and objectives for boilerplate tests. In reply, on July 6, Low said that Kleinknecht had conducted a complete review of flammable materials since receipt of Myers' June 28 letter and that a number of telephone conversations had been held on the subject. MSC recommended that the insulation on the environmental control unit be covered with nickel foil and that silicone-rubber wire-harness clamps could possibly be covered with a combination of "Laddicote" and nitroso rubber. Plans were for the boilerplate mockup tests to use an overloaded wire in a wire bundle as an ignition source. At Myers' suggestion, MSC was also looking into the use of electric arcs, or sparks, as a possible ignition source. Low said: "As you know, our goal in the mockup tests will be to demonstrate that any fire in a 6 psi [4.1 newtons per square centimeter] oxygen atmosphere extinguishes itself. . . . If we can demonstrate that in the 6 psi oxygen atmosphere a fire would spread very slowly so that the crew could easily get out of the spacecraft while on the pad . . . , then I believe that we should also be satisfied."

28

Ltrs., Myers to Low, June 28, 1967; Low to Myers, July 6, 1967.

To prevent flight crew incapacitation from possible carbon dioxide buildup in their Block II spacesuits after emergency exit from a spacecraft, development of a small air bottle was proposed. Bottles, to be attached to the suit to provide proper atmosphere in an emergency, would be stowed on the spacecraft access arm until needed.

July

3

Ltr., Donald K. Slayton, MSC, to ASPO Manager, "Emergency air supply for a suited flight crew during a spacecraft emergency egress," July 3, 1967.

A board was appointed by MSC White Sands Test Facility Manager Martin L. Raines to determine the cause of a fire that had occurred at Test Stand 403 on July 3. The board was to submit its findings by July 17.

5

Ltr., Raines to distr., "Appointment to Investigation Board," July 5, 1967.

A CSM shipment schedule, to be used for planning throughout the Apollo program and as a basis for contract negotiations with North American Aviation, was issued by NASA Hq. The schedule covered CSM 101 through

12

- 1967**
July CSM 115, CSM 105R, and CSM 020 and the period September 29, 1967, through November 17, 1969.
- Ltr., Robert R. Gilruth, MSC, to Samuel C. Phillips, NASA Hq., July 12, 1967; TWX, Phillips to Gilruth and George M. Low, MSC, July 24, 1967.
- 18** Kurt H. Debus, KSC Director, appointed John Bailey of MSC Chairman of an ad hoc Safety Group, following discussions with George E. Mueller of NASA OMSF, MSC Director Robert R. Gilruth, and MSFC Director Wernher von Braun. The Safety Group was to examine the overall operating plans, organizational responsibilities, flight hardware, and ground support equipment and to identify existing and potential personnel hazards associated with the preparation, checkout, and launch of Apollo 4 (AS-501). The group would submit an initial report by August 15.
- Ltr., Debus to Bailey, "Establishment of Apollo 4 (AS-501) Ad Hoc Safety Group," July 18, 1967.
- 18** Visual display systems of complex optical devices were being used with the lunar module mission simulators. To help solve problems that some of these systems were creating, assistance was requested from J. E. Kupperian, E. S. Chin, and H. D. Vitagliano, all from Goddard Space Flight Center.
- Ltr., Robert R. Gilruth, MSC, to John F. Clark, GSFC, July 18, 1967.
- 18** CSM flammability mockup testing was discussed at a program review. It was pointed out that boilerplate testing was being conducted at Downey and that an all-up test should not be performed until all individual tests were completed and the final configuration was completely established.
- Memo, George M. Low, MSC, to Kenneth S. Kleinknecht, MSC, "Flammability mockup testing," July 21, 1967.
- 19** In a letter to Apollo Program Director Samuel C. Phillips, MSC Director Robert R. Gilruth requested that the Boeing Company personnel ceiling be increased to 373. This action was taken as a result of a reevaluation of the requirement of basic task statements and a better understanding of the tasks to be performed. During the planning sessions on the new contract with Boeing, a manpower ceiling of 250 had been established.
- Ltr., Gilruth to Phillips, July 19, 1967.
- 21** The RTG Review Team—established to investigate the relation of the radioisotope thermoelectric generator's fuel-cask subsystem to Apollo mission safety and success—submitted a preliminary report. Apollo Program Director Samuel C. Phillips had established the team after concern was expressed over the design and safety of the subsystem at a June 1 review at NASA Hq. of the Apollo Lunar Surface Experiments Package (ALSEP).
- The team's preliminary report was based on data received and observations of the LM at Grumman that indicated the interface of the RTG, LM, and spacecraft-LM adapter (SLA) presented a potential problem to the Apollo

mission. The most serious hazard was the presence of the 530–640 K (500–700°F) RTG fuel cask in the space between the LM and the SLA, where leaks were possible during fuel unloading or in the mechanical joints of the LM fuel system.

1967

July

Plans were to fuel the LM four days before launch and to pressurize the LM fuel system at T (time of launch) minus 16 hours. The RTG fuel element was to be loaded into the graphite cask, which was mounted on the LM at T minus 12 hours and the system secured. All work would be completed on the ALSEP by T minus 10 hours. If a condition occurred that required unloading fuel from the LM after installation of the fuel element in the cask, the hot cask would be a partial barrier to reaching one of the fuel unloading points and also would be a potential fire hazard. No mechanism was available to remove the entire cask system rapidly. Other potential problems were: (1) a review showed all propellants that could come into contact with the cask had spontaneous ignition temperatures below the temperature of the RTG cask, and thus fuel vapors could be a problem; (2) after launch no indicators would be available to show the crew the status of the RTG or the SLA area, and no jettisoning mechanism was available for the RTG fuel cask; and (3) during deployment of the ALSEP on the lunar surface the astronauts would be required to remove the RTG fuel element and load it into the RTG assembly. While handling tools were available for this operation, no means had been demonstrated to protect the spacesuit if accidentally brushed against the cask.

"Radioisotopic Thermoelectric Generator Review Team Preliminary Report," July 21, 1967.

A series of oxygen purge system (OPS) transfer runs were conducted in the Water Immersion Facility at MSC. Preliminary reports indicated the results of the tests were highly satisfactory, but an assessment of pad abort procedures following several runs in the Apollo Mission Simulator were not so promising. Further work and study in this area was in progress.

22

Memos, Donald K. Slayton, MSC, to George M. Low, MSC, "Preliminary evaluation of Pad Abort and Oxygen Purge System (OPS) Transfer Procedures," July 26, 1967; Low to Slayton, "Pad abort procedures and Oxygen Purge System transfers," July 29, 1967.

The ASPO Manager summarized the lunar module oxygen capacity and design requirements for the lunar mission and made an analysis of his decision to leave both portable life support systems (PLSS) on the lunar surface. He recommended that NASA OMSF accept the PLSS discard philosophy as well as the design capacity for lunar module oxygen.

24

Ltrs., George M. Low, MSC, to Samuel C. Phillips, NASA Hq., July 24, 1967; Phillips to Low, Aug. 10, 1967.

ASPO Manager George M. Low issued instructions that the changes and actions to be carried out by MSC as a result of the AS-204 accident investigation were the responsibility of CSM Manager Kenneth S.

24

- 1967**
July Kleinknecht. The changes and actions were summarized in Apollo Program Directive No. 29, dated July 6, 1967.
Memo, George M. Low to distr., July 24, 1967.
- 25** Following a series of discussions on the requirements for the lunar mapping and survey system (LMSS), the effort was terminated. An immediate stop work order was issued to the Air Force, the Centers, and the contractors in the LMSS effort. The original justification for the LMSS, a backup Apollo site certification capability in the event of Surveyor or Lunar Orbiter inadequacies, was no longer valid, since at least four Apollo sites had been certified and the last Lunar Orbiter would, if successful, increase that to eight.
Memos, Robert C. Seamans, Jr., NASA Hq., to George E. Mueller, NASA Hq., "Lunar Mapping and Survey System (LMSS)," July 13, 1967; Mueller to Seamans, same subject, July 18, 1967; Seamans to Mueller, "Termination of the Lunar Mapping and Survey System," July 25, 1967.
- 25** MSC Director of Flight Operations Christopher C. Kraft, Jr., raised questions about lunar module number 2: Would it be possible for LM-2 to be a combined manned and unmanned vehicle; that is, have the capability to make an unmanned burn first and then be manned for additional activities? Would additional batteries in the LM provide greater flexibility for earth-orbital missions? Mission flexibility would be worthwhile only if it allowed deletion of a subsequent mission, at least on paper.
Memo, G. M. Low, MSC, to O. E. Maynard, MSC, "LM mission flexibility and other points," July 25, 1967.
- 26** The Air Force Chief of Staff announced the reassignment of Carroll H. Bolender from Washington to Houston as Program Manager for the lunar module at MSC. He had been Apollo Mission Director at NASA Hq.
TWX, Air Force Chief of Staff to NASA Hq. and MSC, July 26, 1967.
- 26** MSC asked continued engineering and inspection support from KSC, although increased activity at KSC was making support and factory operations more difficult. KSC had provided support for LM-1 at Bethpage, Long Island, and had also provided support for previous CSM and some Gemini vehicles. The aid of the KSC inspection personnel was particularly beneficial in ensuring a smooth transition of the vehicle from the factory to the field.
Ltr., Robert R. Gilruth, MSC, to Kurt H. Debus, KSC, July 26, 1967.
- 27** MSC Director Robert R. Gilruth wrote MSFC Director Wernher von Braun that MSC had two lunar landing research vehicles (LLRVs) for crew training and three lunar landing training vehicles (LLTVs) were being procured from Bell Aerosystems Co. Gilruth explained that x-ray inspection of welds on the LLTVs at both Bell and MSC had disclosed apparent

subsurface defects, such as cracks and lack of fusion. There was, however, question as to the interpretation of the x-rays and the amount of feasible repair. Gilruth mentioned that James Kingsbury of MSFC had previously assisted MSC in interpreting weldment x-rays, stated that further x-rays were being taken, and asked MSFC assistance in interpreting them and in determining the amount and methods of repair needed.

1967

July

Ltr., Gilruth to von Braun, July 27, 1967.

ASPO announced that a detailed review of the Block II CSM would be held to gain a better understanding of the hardware. ASPO Manager George M. Low pointed out that it had been customary in the Gemini and Apollo Programs to conduct Design Certification Reviews (DCRs) before manned flight of the "first of a kind" vehicle. He added that the detailed review should address itself to design and analysis, test history and evaluation of test results, and the understanding of operational procedures for each element in the CSM. To ensure the most thorough review, MSC divisions would conduct preliminary reviews. The division chiefs would then present their findings to the directorates, the ASPO management, and the MSC Director.

28

Memo, George M. Low to distr., July 28, 1967.

Rocketdyne Division of North American Aviation was selected for negotiation of a contract for the design, development, qualification, and delivery of four production models of an injector for the lunar module ascent engine. The project would serve as a backup to the injector program already being conducted by Bell Aerospace Corp. under subcontract to Grumman. The ascent engine was considered to be the most critical engine in the Apollo-Saturn vehicle. No backup mode of operation remained if the ascent engine failed.

August

1

Ltrs., Samuel C. Phillips, NASA Hq., to George M. Low, MSC, Aug. 16, 1967; George E. Mueller, NASA Hq., to Robert R. Gilruth, MSC, Aug. 17, 1967; NASA News Release 67-207, Aug. 2, 1967.

Kenneth S. Kleinknecht, CSM Manager at MSC, requested that North American organize a team of engineers with broad design backgrounds to make an independent assessment of component design efficiency. The team would identify actions to reduce spacecraft weight and to establish control methods to prevent future weight increases. The team would be placed under the leadership of a North American employee with broad knowledge of Apollo hardware.

1

To deal with Apollo weight problems, North American replied in October, accurate and timely weight visibility was of paramount importance. To provide this visibility, North American used system design personnel directly in weight prediction and reporting. As part of this plan, all engineering-design-change documentation would contain a delta weight effect that would be reviewed and approved by engineering management;

1967
August

weight trends and status would be reported monthly to North American and NASA management. A list of weight reduction candidates was suggested to NASA.

Ltr., Kleinknecht to Dale D. Myers, North American Aviation, Aug. 1, 1967; ltr., Myers to George M. Low, MSC, Oct. 5, 1967.

1-11

Lunar Orbiter V was launched from the Eastern Test Range at 6:33 p.m. EDT August 1. The Deep Space Net Tracking Station at Woomera, Australia, acquired the spacecraft about 50 minutes after liftoff. Signals indicated that all systems were performing normally and that temperatures were within acceptable limits. At 12:48 p.m. EDT August 5, *Lunar Orbiter V* executed a deboost maneuver that placed it in orbit around the moon. The spacecraft took its first photograph of the moon at 7:22 a.m. EDT August 6. Before it landed on the lunar surface on January 31, 1968, *Lunar Orbiter V* had photographed 23 previously unphotographed areas of the moon's far side, the first photo of the full earth, 36 sites of scientific interest, and 5 Apollo sites for a total of 425 photos.

Lunar Orbiter V Post Launch Reports 1 through 7, Aug. 2, 3, 7, 9, 11, 1969; *Astronautics and Aeronautics, 1967* (NASA SP-4008, 1968), pp. 229, 235, 417.

11

Apollo Program Director Samuel C. Phillips was appointed Chairman of a NASA task group, reporting to Administrator James E. Webb, Deputy Administrator Robert C. Seamans, Jr., and Associate Administrator for Manned Space Flight George E. Mueller. The group was chartered to review the content of the Apollo program in order to determine alternatives necessary for programming and budget planning decisions. It would inquire into and report on all aspects of the Apollo program necessary to provide a base of accurate data and information to support decisions on FY 1968 expenditure control and FY 1969 budget planning. Specifically, the group was requested to identify planned activities that could be eliminated if the Apollo program were to be terminated with the manned lunar landing. The group was also requested to determine the effect of placing a hold order on production of Saturn V vehicles 512 through 515 and to develop the cost estimates resulting from these actions as well as other tangible alternatives.

Memo, Webb to Phillips, "Review of Apollo Program," Aug. 11, 1967.

15

ASPO wrote Lewis Research Center about studies of ignition sources inside the pressure suits worn by the astronauts. In recent tests, the communications and biomedical circuits inside the suit and connected to the spacecraft panel through the crewman electrical umbilical were evaluated to determine the ignition characteristics. Studies on the flammability of various materials used in the suit loop had been completed and the data compiled.

Memo, G. M. Low, MSC, to I. I. Pinkel, Lewis Research Center, "Ignition source inside the suit," Aug. 15, 1967.

The NASA task team for CSM Block II redefinition, established on April 27, was phased out. During its duration the task team provided timely response and direction in the areas of detail design, overall quality and reliability, test and checkout, baseline specifications, and schedules. With the phaseout of the team, Apollo Spacecraft Program Office policies and procedures would be carried out by the ASPO resident manager. A single informal point of contact was also established between MSC and North American for engineering and design items.

1967**August****18**

Memo, Kenneth S. Kleinknecht, MSC, to distr., "Phaseout of the NASA Task Team for Block II Redefinition, Command and Service Modules," Aug. 18, 1967.

ASPO Manager George M. Low, in a letter to Dale D. Myers of North American Aviation, expressed disappointment that both spacecraft 2TV-1 and 101 had slipped approximately six weeks. He also expressed astonishment that managers, who were supposedly using a planning system, did not understand the meaning of the charts they were using. Low suggested more attention to detail by managers, a better tracking system for shortages, assignment of responsible individuals to areas where special efforts were needed; and a mechanized system for tracking such things as work needing to be done and shortages.

19

Ltr., Low to Myers, Aug. 19, 1967.

A senior design review group was established to review the command module stowed equipment and the stowage provisions, to ensure the timely resolution and implementation of changes necessary because of new materials criteria and guidelines. Robert R. Gilruth, MSC Director, would head the group.

22

Memo, George M. Low, MSC, to distr., "Design Review of Command Module storage provisions," Aug. 22, 1967.

An interagency agreement on protecting the earth's biosphere from lunar sources of contamination was signed by James E. Webb, NASA; John W. Gardiner, HEW; Orville L. Freeman, Department of Agriculture; Stewart L. Udall, Department of Interior; and Frederick Seitz, National Academy of Sciences. The agreement established a committee to advise the NASA Administrator on back contamination and the protection of the biological and chemical integrity of lunar samples, on when and how astronauts and lunar samples might be released from quarantine, and on policy matters.

24

Interagency Agreement between the National Aeronautics and Space Administration, the Department of Agriculture, the Department of Health, Education, and Welfare, the Department of Interior, and the National Academy of Sciences on the Protection of the Earth's Biosphere from Lunar Sources of Contamination, Aug. 24, 1967.

Grumman proposed a procurement for a study of the mission effects projector, to assist Grumman with an item that had been designed and built by Farrand but did not meet the established specifications. Grumman solicited assistance of qualified firms in the optomechanical field. Of 15

Week Ending**August 25**

1967

August

firms approached 7 were interested: Itek Corp., Kollmorgen Corp., Bausch & Lomb, Inc., Kollsman Instrument Corp., Biorad, General Precision Link Group, and Conductron. Technical proposals were received from Itek, Biorad, Link, and Conductron. Grumman considered the Itek proposal most technically acceptable and proposed a letter contract in which NASA concurred.

MSC, BMR Bethpage, "Weekly Activities Report, Week Ending August 25, 1967," Aug. 30, 1967.

26

"Reuse of failed equipment" was the subject of a memorandum to W. M. Bland in the MSC Reliability and Quality Assurance Office from ASPO Manager George M. Low. He said: "I have recently heard of several instances of reuse of apparently failed equipment without any fixes applied to that equipment. I understand that, if a component or subsystem is removed from the spacecraft because it has apparently failed but a subsequent failure analysis does not show anything to be wrong with the equipment, the equipment is then put back into stock for reinstallation. It appears to me that, if a component is once suspected or known to have caused a failure or to have failed, it should not be allowed back in the program unless a fix has been made or unless it has been proved conclusively that the failure was not caused by that component. If we do not now have a program directive that states such a policy, I think we should impose one as quickly as possible and set up adequate procedures to control it."

Memo, Low to Bland, Aug. 26, 1967.

30

A review team's findings on the lunar surface magnetometer program were reported to the NASA Administrator. The magnetometer program still suffered from the schedule delays and high costs that had prompted the review, but recent management changes and technical progress were halting the trends. With the team recommendation and the endorsement of the Office of Space Science and Applications, Philco Corp. was directed to continue its effort to develop a lunar surface magnetometer.

Memos, Samuel C. Phillips, NASA Hq., to NASA Administrator, "Lunar Surface Magnetometer," Aug. 30, 1967; W. H. Close, NASA Hq., to Deputy Administrator, "ALSEP Lunar Surface Magnetometer," Oct. 13, 1967.

September

1

An Apollo test flow study group was formed to make a detailed evaluation of spacecraft, launch vehicle, and space vehicle testing at KSC. The group was composed of aerospace industry and NASA personnel.

Memo, R. O. Middleton, KSC, to G. M. Low, MSC, "Apollo Test Flow Study Group," Sept. 1, 1967.

6

Apollo Program Directive No. 31 established and implemented the Apollo System Safety program and defined program requirements in consonance with NASA Management Instruction 1138.12, August 29, 1967. The directive was applicable to all Apollo Headquarters and Center System Safety activities and it spelled out Headquarters and Center Apollo

responsibilities. Among Center requirements were: (1) "An office responsible for Apollo System Safety shall be established in accordance with the requirements set forth in NASA Management Instruction #1138.12." (2) "Each Center office for Apollo System Safety shall prepare a plan that describes the safety tasks to be performed and the method to be used for the accomplishment of these tasks. . . ."

On September 20, ASPO Manager George Low asked Aleck Bond of the MSC Engineering and Development Office if he was taking action. Bond replied that the Flight Safety Office was preparing an overall safety plan for the Center that would meet the requirements of the directive. In an October 16 letter to Apollo Program Director Samuel C. Phillips, Low pointed out that "The . . . directive stipulates that an office responsible for Apollo System Safety shall be established. . . . In reviewing this Management Instruction we can find no mention of such a Center office. . . ." Low added that ASPO had appointed an Assistant Program Manager for Flight Safety who would work with the MSC Flight Safety Office and ensure that the Center's flight safety policies and procedures were carried out throughout the Apollo spacecraft program.

Apollo Program Directive No. 31, "Apollo System Safety Program Requirements," Sept. 6, 1967; informal note, Low to Bond, Sept. 20, 1967; memo, Bond to Low, "Apollo Program Directive No. 31—Apollo System Safety Program Requirements," Sept. 25, 1967; ltr., Low to Phillips, "APD No. 31—Apollo System Safety Program Requirements," Oct. 16, 1967.

LM-1 (Apollo 5) continued to have serious schedule difficulties. However, all known problems were resolved with the exception of the propulsion system leaks. Leak checks of the ascent stage indicated excessive leaking in

7

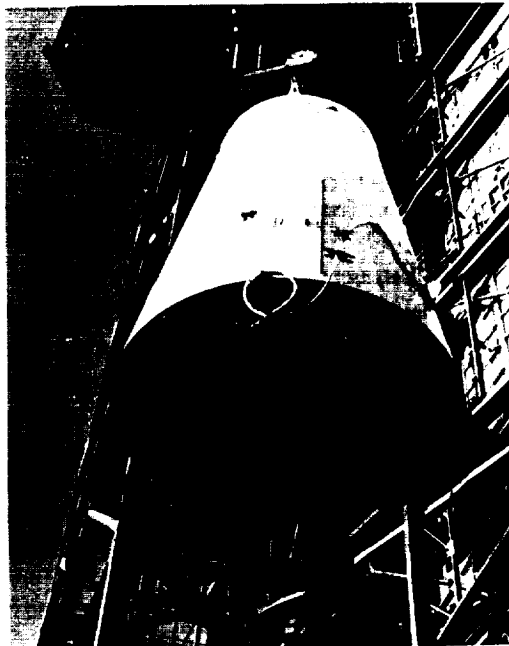

LM-1, fitted inside spacecraft-lunar module adapter 7, is raised to position at Kennedy Space Center in preparation for the Apollo 5 mission.

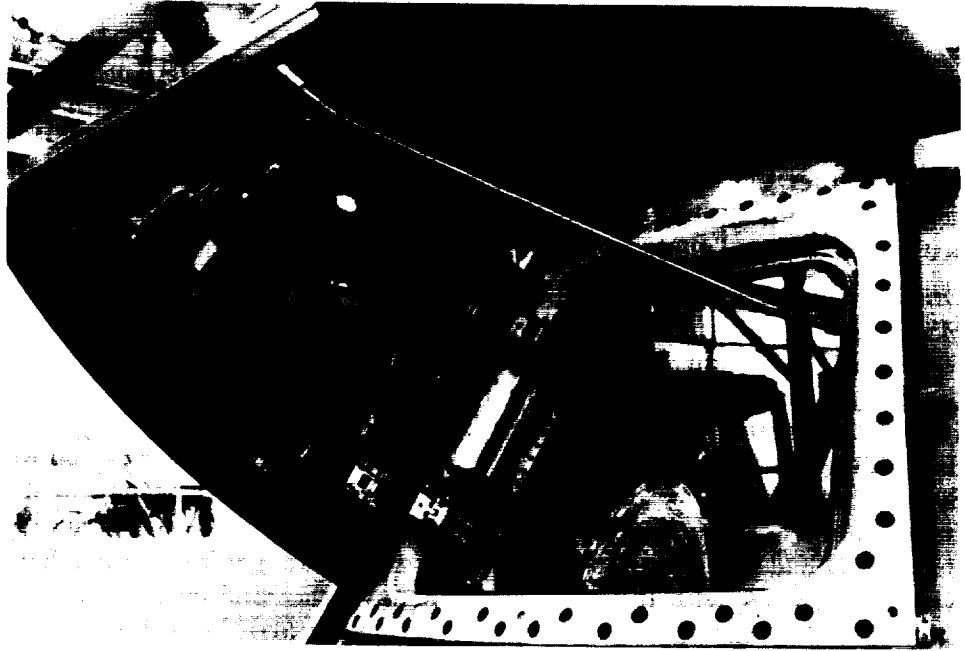

The new unified hatch of the Apollo CM is checked at North American after its development, testing, and manufacture. The Block I hatch on the ill-fated CM 012 had consisted of an outer and an inner hatch.

1967
September

the incline oxidizer orifice flange. The spacecraft was approximately 39 days behind the July 18, LM-1 KSC Operations Flow Plan.

MSC, "ASPO Weekly Project Status Report," Sept. 7, 1967.

8

A revised spacecraft delivery schedule with a maximum delivery rate of six spacecraft per year as opposed to a delivery rate of one spacecraft every six weeks for the Apollo program was proposed by MSC and approved by NASA Hq.

Ltr., Robert R. Gilruth, MSC, to Samuel C. Phillips, NASA Hq., Sept. 8, 1967; TWX, Phillips to Gilruth, "CSM Delivery Schedules," Sept. 22, 1967.

9

ASPO Manager George Low in a letter to Dale Myers of North American Aviation, emphasized that the spacecraft weight situation was the single most serious problem in the entire Apollo program. An example of the weight estimating problem was the spacecraft hatch. When the decision was made in March 1967 to incorporate a new hatch, the net weight increase was estimated at 185 kilograms, but calculations indicated that this increase was actually 558 kilograms. Neither of these numbers included the additional ballast, which doubled the required weight. Clearly weight estimates were inadequate, making a workable weight control program impossible. North

1967
September

American was requested to take immediate action to bring the weight problem under control. A letter in a similar vein was sent by C. H. Bolender, ASPO LM Manager, to J. G. Gavin, Jr., Grumman Aircraft Engineering Corp.

Ltr., Low to Myers, Sept. 9, 1967; Bolender to Gavin, Sept. 22, 1967.

A short circuit occurred during checkout of CSM 020 at North American, Downey, Calif. External power batteries in parallel with the reentry batteries had indicated low power and were replaced. During preparations to continue the test, arcing was reported and emergency shutdown procedures were applied. Investigation was under way to determine the cause of the arcing. Initial indications were that at least 100 amps were imposed on a small portion of the spacecraft wiring, causing some damage to the spacecraft batteries.

15

TWX, ASPO Manager to Director, Apollo Spacecraft Program, Sept. 18, 1967.

During operational checkout procedures on CSM 017, which included running the erasable memory program before running the low-altitude aborts, the guidance and navigation computer accidentally received a liftoff signal and locked up. Investigation was initiated to determine the reason for the liftoff signal and the computer lockup (switch to internal control). No damage was suspected.

16

TWX, ASPO Manager to Director, Apollo Program Office, Sept. 18, 1967.

The Systems Engineering Division of ASPO presented a briefing to the ASPO Manager and other MSC officials on the logic of the lunar surface activity for the first lunar landing mission. Several potential missions were presented in terms of interactions between timelines, consumables, weight, and performance characteristics. Purpose of the demonstration was to elicit policy decisions on the number of extravehicular excursions to be planned for the first mission as well as the activities for each excursion. The following ground rules were established: (1) Priority of scientific objectives would be, in order, minimum lunar sample, ALSEP, and lunar geologic survey including sample collection. (2) The first EVA on the lunar surface during the first lunar mission would consist of a set of simplified, mutually independent activities and the timeline would permit rest periods between each activity. The minimum lunar sample would be collected during the first EVA but the ALSEP would not be deployed. (3) A second EVA would be included for planning purposes and would include ALSEP deployment. The second EVA would not be considered a primary mission objective. (4) For mission planning purposes the 22½-hour lunar surface staytime would be pursued as the prime candidate for the first lunar landing mission.

18

Memo, George M. Low, MSC, to distr., "Surface activity during first lunar landing mission," Sept. 18, 1967.

1967
September
18

Garrett Corp. Vice President Mark E. Bradley sent recommendations of the Garrett-AiResearch Safety Audit Review Board to Dale D. Myers, Vice President and Project Manager, Apollo Program, North American Aviation. Bradley said the Board had been appointed in May 1967 to make "an independent review of ECS [environmental control system] systems and components from a crew safety standpoint" and that the recommendations were "based on the considered professional judgment of the Board members without bias or prejudice with regard to cost or schedule."

In a reply to Bradley on October 21, Myers said: "Your letter has been reviewed in detail and it has been determined in some cases the recommendations are of a design improvement nature. . . . Because of the seriousness of your conclusions and recommendations, I believe it necessary and pertinent the following comments be made. . . . The magnitude and complexity of the Apollo program precludes any single system subcontractor the capability of full and knowledgeable assessment of the effects his system has on the whole. . . . This is not a criticism of your Safety Board function, rather a criticism of the charter and ground rules on which the Board's recommendations are based. . . . It is disturbing to me to find your letter is being used as a vehicle to attempt reconsideration of Engineering Design Change Proposals (EDCP's) already given careful consideration and a subsequent disposition made. . . . I must insist that future Board comments be channeled through your Apollo project group for processing by the established EDCP procedures. If the EDCP affects Crew Safety or Mission success, it should be so indicated in the EDCP and will be given proper consideration by the management of NAR and NASA. . . . Because of the seriousness of your conclusions and recommendations, I am asking the NASA ASPO to form a Board with me to review your recommendations with you for disposition. . . ."

Myers also wrote ASPO Manager George Low on October 21, enclosing the AiResearch recommendations. He said: "I found that AiResearch had used different criteria for evaluation than we use, but I felt we have a situation that requires immediate and joint top-level review by us. . . . The Board made significant recommendations that could constrain a manned flight with the current configuration of the ECS. I hope that this is not the case and that the recommendations were meant to be in the area of design improvement rather than constraints of Crew Safety or Mission Success nature. . . . If you agree with the need for this NASA/NAR joint ECS Safety Review Board, I will arrange such a meeting with the AiResearch Review Board."

Low replied to Myers on October 30, saying, "I agree with you that we should give serious consideration to each of the AiResearch recommendations and that a joint NASA/NAR Safety Review Board would be the best means of accomplishing this. I would be pleased to serve on such a board with you. . . ." Low asked Myers to set up the meeting following the Apollo 4 mission.

In a November 7 meeting at MSC the AiResearch Safety Board recommendations were discussed and initial dispositions made, with AiResearch being asked to provide a written acceptance or rejection of each.

1967
September

Ltrs., Bradley to Myers, "Recommendation of Garrett-AiResearch Safety Audit Review Board," Sept. 18, 1967; Myers to Bradley, Oct. 21, 1967; Myers to Low, Oct. 21, 1967; Low to Myers, Oct. 30, 1967; Myers to Low, Dec. 13, 1967; Low to Myers, Mar. 19, 1968.

MSC proposed to the NASA Office of Manned Space Flight a sequence of missions leading to a lunar landing mission. The sequence included the following basic missions:

20

- A—Saturn V/unmanned CSM development
- B—Saturn IB/unmanned LM development
- C—Saturn IB/manned CSM evaluation
- D—Saturn V/manned CSM and LM development (A dual Saturn IB mission would be an alternative to the Saturn V for mission D)
- E—CSM/LM operations in high earth orbit
- F—Lunar orbit mission
- G—Lunar landing mission (like Apollo 11)
- H—Lunar landing mission (Apollo 12, 13, and 14)
- I—Reserved for lunar survey missions (not used)
- J—Lunar landing missions, upgraded hardware (Apollo 15, 16, and 17)

Memos, George M. Low, ASPO Manager, to distr., "Mission development and planning," Sept. 25, 1967; Low to Director, MSC, "Meetings with General Phillips and Dr. Mueller," Sept. 9, 1967; ltr., Robert R. Gilruth, MSC, to George E. Mueller, NASA Hq., Sept. 19, 1967; telecon, Ivan D. Ertel to John Sevier, Feb. 26, 1975.

At the request of Congress NASA was preparing a formal document on all the action items resulting from the January 27 AS-204 accident. The document would be used as a report to the entire Congress by the responsible Senate and House subcommittees and was expected to include two volumes. The first would cover Apollo 204 Review Board findings; the second would cover panel findings, results of Congressional testimony, and Apollo program direction. The report was forwarded to Congress in December 1967 (House) and January 1968 (Senate).

21

Ltr., Samuel C. Phillips, NASA Hq., to George M. Low, MSC, "AS-204 Accident Closeout Report," Sept. 21, 1967. House Committee on Science and Astronautics, Subcommittee on NASA Oversight, *Status of Actions Taken on Recommendations of the Apollo 204 Accident Review Board*, 90th Cong, 2d sess., Committee Print, Serial L, 1968; Senate Committee on Aeronautical and Space Sciences, *Apollo Accident: Hearings*, 90th Cong., 2d sess., pt. 8, January 1968.

C. H. Bolender, ASPO Manager for the lunar module, wrote Joseph G. Gavin, Jr., Grumman LM Program Director, that recent LM weights and weight growth trends during the past several months established the need to identify actions that would reduce weight and preclude future weight growth. He pointed out that the Configuration Control Board (CCB) at

22

1967
September

MSC had emphasized such actions, while recognizing the specific weight increases associated with design change actions resulting from the AS-204 accident. Several other design corrections or improvements had been implemented, such as increased plume protection, ascent engine reflection protection, descent stage upper-deck structural repair, and landing gear shielding. Bolender told Gavin, "We cannot afford to exercise ultra-conservatism as an expedient to problem solving. The modification of the descent stage skin panels may be a case in point. . . . We have already asked that in consideration of minimum weight design, you reassess your recommendation to change to a uniform panel thickness." He requested that the objectives of the recent Super Weight Improvement program (a weight saving "tool" employed by Grumman) be reiterated in design activity and that weight reduction suggestions be solicited and evaluated for implementation. Bolender requested a biweekly review of weight reduction candidate changes and told Gavin he was asking Systems Engineering Division to maintain close coordination with Grumman and to report progress of the weight reduction and control activity at the regular CCB meetings.

Ltr., Bolender to Gavin, Sept. 22, 1967.

- 22** The merger of North American Aviation, Inc., and Rockwell-Standard Corp. became effective and was announced. The company was organized into two major groups, the Commercial Products Group and the Aerospace and Systems Group. The new company would be known as North American Rockwell and use the acronym NR.

North American Rockwell Corp., "A First Look," Sept. 22, 1967,

- 25** Associate Administrator for Advanced Research and Technology Mac C. Adams requested concurrence of MSC Director Robert R. Gilruth to naming the following as members of Research Advisory Committees for Fiscal Year 1968: Christopher C. Kraft, Jr., Committee on Space Vehicles; Joseph G. Thibodaux, Jr., Committee on Chemical Rocket Propulsion; Charles A. Berry and Richard S. Johnston, Committee on Biotechnology; and Robert E. Johnson, Subcommittee on Materials. Gilruth concurred on September 28.

Ltrs., Adams to Gilruth, Sept. 25, 1967; Gilruth to Adams, Sept. 28, 1967.

- 26** The Flammability Test Review Board met at MSC to determine if the M-6 vehicle (a full-scale mockup of the LM cabin interior) was ready for test and that the ignition points, configuration, instrumentation, and test facility were acceptable for verifying the fire safety of LTA-8 and LM-2 vehicles. The Board agreed that the M-6 did accurately and adequately simulate the LTA-8 and the LM-2 and established that the M-6 mockup was ready for testing. The Board was composed of Robert R. Gilruth, Chairman; Carroll H. Bolender; Aleck C. Bond; Maxime A. Faget; Christopher C. Kraft, Jr.;

Donald K. Slayton; A. Duane Catterson, all of MSC; E. Z. Gray of Grumman; and G. H. Stoner of Boeing, a nonvoting observer.

1967

September

Ltr., Gilruth to distr., "Minutes of the Flammability Test Review Board Meeting No. 1," Oct. 23, 1967; memo, Joseph N. Kotanchik, Chief, Structures and Mechanics Div. to distr., "Progress Report on Lunar Module M-6 flammability mockup," Sept. 28, 1967.

In spite of efforts to eliminate all flammable materials from the interior of the spacecraft cabin during flight, it was apparent that this could not be completely accomplished. For example, silicone rubber hoses, flight logs, food, tissues, and other materials would be exposed within the cabin during portions of the mission. However, flammable materials would be outside their containers only when actually needed. Special fire extinguishers would be carried during flight.

28

Memos, George M. Low, MSC, to Donald K. Slayton, MSC, "Procedures for use of flammable material in spacecraft," Sept. 28, 1967; Low to Slayton, "Training in use of fire extinguishers," Sept. 28, 1967.

ASPO Manager George M. Low informed the MSC Director of Flight Crew Operations that effective November 1 configuration management of the Apollo mission simulators and LM mission simulators would be transferred from ASPO to the Flight Crew Operations Directorate, with the understanding that Director Donald K. Slayton would personally chair the Configuration Control Panel.

28

Memo, Low to D. K. Slayton, "Configuration Control Panel for simulators," Sept. 10, 1967.

MSC's Engineering and Development (E&D) Directorate recommended that the Apollo CM be provided with a foam fire extinguisher. E&D also recommended that the LM be provided with a water nozzle for extinguishing open fires and that cabin decompression be used to combat fires behind panels. An aqueous gel (foam) composition fire extinguisher was considered most appropriate for use in the CM because hydrogen in the available water supply could intensify the fire, water spray could not reach fires behind panels, and a shirt-sleeve environment was preferred. E&D further recommended that development of a condensation nuclei indicator be pursued as a flight fire detection system, but that it not be made a constraint on the Apollo program. ASPO Manager George M. Low concurred with the recommendations September 28 and MSC Director Robert R. Gilruth concurred October 7.

28

On October 26, the Director of Flight Crew Operations stated that his Directorate was formulating and implementing a training program for flight crews to give them experience in coping with fire in and around the spacecraft. "In total, the crew training for cockpit fires will consist of: Review of BP 1224 and M-6 'burn test' film; demonstration briefings on the fire extinguishers and their most effective use; procedural practice simulating cockpit fire situations in conjunction with one 'g' spacecraft/mockup/Apollo Mission Simulator walkthroughs and in the egress

1967
September

trainer placed in the altitude chamber; and as a part of the overall launch pad emergency and evacuation procedures training at the fire service training area at KSC."

Memos, Low to Donald K. Slayton, "Training in use of fire extinguishers," Sept. 28, 1967; Slayton to Low, "Crew training in use of fire extinguishers," Oct. 26, 1967; Maxime A. Faget to Gilruth, "Information Staff Paper No. 41—Spacecraft fire extinguishing systems and onboard spacecraft fire detection instrumentation for the Apollo program," Sept. 28, 1967.

29

ASPO Manager George M. Low, in a letter to Richard E. Horner, Senior Vice President of Northrop Corp., following a phone call to Horner on Sept. 28, reiterated NASA's "continuing and serious concern with the quality control at Northrop Ventura on the Apollo spacecraft parachute system. In recent weeks, I have had many reports of poor workmanship and poor quality, both in the plant at Northrop Ventura and in the field at El Centro."

On October 20 Horner told Low he had taken time to assure himself of the best possible information available before replying and offered background on the situation: "The design effort goes back to 1961 and testing began at the El Centro facility in 1962. There was continuous operation of the test group at El Centro until 1966 when the completion of the Block II testing program dictated the closeout of our operation there. In our total activity, we have had a peak of 350 personnel assigned to the Apollo, with 20 of that number located at El Centro during the most active portion of the test program. When it was finally determined that the increased weight capability redesign was necessary for mission success, the program nucleus had been reduced to 30 personnel and the established schedule for the system re-design, test and fabrication requires a build-up to 250. . . . The schedule has also dictated the adoption of such procedures as concurrent inspection by the inspectors of Northrop, North American and NASA, a procedure which, I am sure, is efficient from a program point of view but is inherently risky in terms of the wide dissemination of knowledge concerning every human mistake. This is significant only from the point of view of the natural human failing to be more willing to share the responsibility for error than for success. . . . We do not intend in any way to share responsibility for these errors and expect to eliminate the potential for their recurrence. We have established standards of quality for this program that are stringent and uncompromising. . . . Even though the technical and schedule challenge is substantial, we are confident that by the time qualification testing is scheduled to start during the first week of December 1967 we will have a flawless operation. . . ."

Ltrs., Low to Horner, Sept. 29, 1967; Horner to Low, Oct. 20, 1967; memos, Low to Kenneth S. Kleinknecht, "Parachute packing," Sept. 1, 1967; Low to Donald K. Slayton, "Apollo parachutes," Sept. 23, 1967.

29

An Apollo Entry Performance Review Board was established by the MSC Director to review and validate the analytical tools as well as the Apollo operational corridor. The Board was set up because the performance of the ablation heatshield in the Apollo spacecraft, as then analyzed, imposed a

limitation on the entry corridor at lunar return velocity. The following were named to the Board: Maxime A. Faget, MSC, chairman; Kenneth S. Kleinknecht, MSC; Eugene C. Draley and Don D. Davis, Jr., Langley Research Center; Alvin Seiff and Glen Goodwin, Ames Research Center; and Leo T. Chauvin, MSC, secretary.

1967
September

Ltrs., MSC Director Robert R. Gilruth to Directors of Ames Research Center and Langley Research Center, Sept. 29, 1967.

Key dates in the spacecraft 101 schedule were agreed to during a meeting of Samuel C. Phillips, Robert R. Gilruth, George M. Low, and Kenneth S. Kleinknecht with North American management: inspection of wiring, October 7, 1967; completion of manufacturing, December 15, 1967; delivery, March 15, 1968. In addition, several decisions were reached concerning certain systems of spacecraft 101. Among these, it was agreed that the entry monitor system would not be checked out on spacecraft 101 (see October 12).

29

Memo for the Record, George M. Low, Manager, ASPO, "North American activities," Oct. 2, 1967.

Because of many questions asked about spacecraft weight changes in the spacecraft redefinition, ASPO Manager George M. Low prepared a memo for the record, indicating weights as follows:

29

*Lunar Module Significant Weight Changes
March-September 1967*

- Lunar module injected weight status March 1, 1967
(ascent and descent less propellant) 4039.6 kg

Material substitution + 23.1; decrease clamps and potting, - 4.5; government furnished equipment changes (pressure garment assembly, portable life support system, oxygen purge system), + 68; plume heating and "fire-in-the-hole" protection, + 59.8; redesign umbilical hoses, + 2.2; revised oxygen and water requirements, + 19.5; provision for ALSEP removal, + 11.3; increasing crack resistance of webs, + 13.6; additional wiring to provide redundant circuits, + 4.9; fuel cask and support increase, + 14.9; guidance and navigation equipment, + 3.1; instrumentation, + 9.9; communications, + 1.8; miscellaneous changes, + 2.2.

Net change from March to September was + 230.4 kg.

- Lunar module injected weight status September 22, 1967 4270.0 kg

*Command Module Significant Weight Changes
March-September 1967*

- Command module injected weight status March 1, 1967 5246.7 kg

1967
September

New hatch, +114.7; environmental control system and weight management system changes, +103.4; instrumentation and electrical power, +48; wiring and tubing protection, +44.4; crew compartment materials and crew equipment, +101.6; forward heatshield separation, +13.6; earth landing system (larger drogues), +21.7; miscellaneous structural changes, +26.7; ballast for lift-over-drag ratio of 0.35, +175; other, +19.5. Reductions—transfer of portable life support system to LM, -31.2; reduced ballast for lift-over-drag ratio of 0.28, -142.8; other MSC weight reductions, -61.6.

Net change from March to September was +433.1 kg.

- Command module injected weight status September 22, 1967 5679.8 kg

Memo for the Record, George M. Low, Manager, ASPO, "Apollo weight changes," Sept. 29, 1967.

October
2

Apollo Program Director Samuel C. Phillips, NASA Hq., reaffirmed that the following was the best course of action to follow with LM-2 and LM-3: "Decide now to configure LM-2 for its unmanned contingency mission and reassign LM-3 to join with CSM 103 for a manned CSM-LM mission. In the event the LM-2 unmanned contingency mission is not required, LM-2 could be reworked to manned configuration and cycled back into the GAEC [Grumman] line for later delivery. On this basis, LM-2 could be delivered in unmanned configuration in late January 1968, or immediately after the Apollo 5 flight, and could be flown on AS-206 about 3½ months after delivery; i.e., in May 1968. The outlook for LM-3 indicates an April 1968 delivery which appears to be compatible with the expected delivery date of CSM 103."

Memos, Phillips to R. C. Seamans, Oct. 2, 1967; G. E. Mueller to Seamans, "LM-2 Configuration," Oct. 2, 1967.

5

An exchange of correspondence between MSC and North American Rockwell emphasized the seriousness of the spacecraft weight problem. Accurate and timely weight visibility was of paramount importance for weight control and resulted from proper implementation and control of weight prediction, weight control from design initiation, and weight status reporting. To ensure visibility, North American Rockwell was instituting a program that would use system design personnel in weight prediction and reporting. Preliminary design personnel in the Design Requirements Group were designated to integrate the effort.

Ltrs., George M. Low, MSC, to Dale D. Myers, North American Rockwell Corp., Aug. 1, 1967; Low to Myers, Aug. 17, 1967; Myers to Low, Oct. 5, 1967.

MSC established an Apollo Spacecraft Incident Investigation and Reporting Panel, with Scott H. Simpkinson as chairman. Panel members would be selected from ASPO, the Flight Safety Office, and the Engineering and Development Directorate. In addition, members would be assigned from the RASPO offices at Downey, Bethpage, and KSC when incidents occurred at their locations. All incidents suspected of directly affecting the safety of the spacecraft or its ground support equipment and all incidents that represented a hazard to personnel working in the area were to be investigated and reported. Incidents having a cost impact of over \$5000 or a schedule impact of 24 hours would also be reported to the panel chairman and considered for investigation. Panel membership was announced October 16. The following day, a letter from Simpkinson to panel members established procedures for investigating and reporting incidents.

1967
October
5-15

MSC Announcement No. 67-136, "Apollo Spacecraft Incident Investigation and Reporting Panel," Oct. 5, 1967; list of members and alternates of Apollo Spacecraft Incident Investigating and Reporting Panel, Oct. 16, 1967; ltr., Scott H. Simpkinson to Apollo Spacecraft Incident Investigation and Reporting Panel, "Implementation of an Apollo Spacecraft Incident Investigation and Reporting Panel," Oct. 16, 1967.

Because of wind conditions, an abort of the Apollo spacecraft from a Saturn V in the near-pad region would result in land impact. To ensure the maximum potential safe recovery of the crew during a near-pad abort, certain forms of preparation within the abort area were being considered. Tests were being prepared at MSC and KSC to determine the most favorable soil condition for spacecraft landing. The capability of the spacecraft to sustain a land impact was also being investigated by MSC.

8

Memo, G. M. Low, MSC, to R. O. Middleton, KSC, "Improvement of landing areas for Apollo near pad aborts," Oct. 8, 1967.

A series of meetings discussed the oxygen purge system (OPS) program status and design configuration. The following conclusions were reached:

10

- The OPS theoretical reliability for completion of a 30-minute operation time was extremely high and would not be appreciably improved by the addition of redundant systems or components.
- Capability for preoperational checkout in the LM was desirable and was incorporated into the OPS design.
- Manual actuation was preferable to automatic actuation and was reflected in the design.

Memo, Maxime A. Faget, MSC, to ASPO Manager, "Oxygen purge system (OPS) review," Oct. 10, 1967.

Key MSC and NASA Headquarters management changes were announced at a press conference at MSC. George S. Trimble, Jr., was transferred from NASA OMSF to serve as Deputy Director of MSC. Eberhard F. M. Rees of MSFC would be temporarily assigned as a Special Assistant on Manufacturing Problems to George M. Low, ASPO Manager. Edgar M. Cortright was named as Deputy to George E. Mueller at OMSF. Participating in the press

12

1967
October

conference were NASA Administrator James E. Webb, Mueller, MSC Director Robert R. Gilruth, Trimble, and MSC Public Affairs Officer Paul P. Haney.

Press Conference Transcript, Tape A, Oct. 12, 1967, pp. 1, 2.

12

ASPO Manager George Low submitted a memorandum for the record on the September 29 decision not to check out the spacecraft 101 entry monitor system (EMS). He said: ". . . it has come to my attention that this decision had been based on incomplete information. Because the EMS incorporates both the Delta V counter and the .05 g indication on Block II spacecraft, this system is required for all missions, including 101. . . . "I verbally directed North American on October 10, 1967, that this system will be checked out on Spacecraft 101."

Memo for Record, Low, "Checkout of entry monitor system," Oct. 12, 1967.

13

In an effort to keep a tight rein on changes made in spacecraft, the Apollo Spacecraft Configuration Control Board (CCB) established the following ground rules:

- All changes on CSMs 101 and 103 and LM-3, no matter how small, would now be considered by the Senior Board only and not by any of the panels.
- Only mandatory changes would be considered for CSMs 101 and 103 and LM-3.
- Final implementation of all changes must be concluded within 30 days after a contract change authorization was written, and no change in implementation would be allowed without a new review by the MSC CCB.
- No changes would be made on LM-6 and subsequent LMs and CSM 107 and subsequent CSMs unless they were also on LM-5 and CSM 106 or unless the Senior CCB made a special exception to this rule. The purpose was to make certain that the configurations of the mission simulators and the Mission Control Center could be stabilized.
- Board members would generally be chairmen of subsidiary Configuration Control Panels and would not delegate this chairmanship. Thus Donald K. Slayton would chair the Simulator Panel, Maxime A. Faget would chair the panel that passed on government furnished equipment items (see October 18), and probably Christopher C. Kraft, Jr., would chair the Software Control Panel (the last position had not yet been decided).

An additional step to gain a better understanding of the configuration baseline was taken by appointing Jesse F. Goree responsible for configuration management.

Ltr., George M. Low, MSC, to Samuel C. Phillips, NASA Hq., Oct. 14, 1967.

13

A proposal to use a Ballute system rather than drogue parachutes to deploy the main chutes on the Apollo spacecraft was rejected. It was conceded that the Ballute system would slightly reduce dynamic pressure and command

module oscillations at main parachute deployment. However, these advantages would be offset by the development risks of incorporating a new and untried system into the Apollo spacecraft at such a late date.

1967

October

Ltr., George M. Low, MSC, to Robert T. Madden, Goodyear Aerospace Corp., Oct. 13, 1967.

NASA Hq. informed MSC that NASA Deputy Administrator Robert C. Seamans, Jr., had approved the project approval document authorizing four additional CSMs beyond No. 115A. MSC was requested to proceed with all necessary procurement actions required to maintain production capability in support of projected schedules for these items.

17

TWX, George E. Mueller, NASA Hq., to Director Robert R. Gilruth, MSC, Oct. 17, 1967.

A conference at NASA Hq. discussed Headquarters and MSC operational problems in the lunar sample program, including the Lunar Receiving Laboratory (LRL). Associate Administrator for Space Science and Applications John E. Naugle chaired the meeting. Lunar Receiving Operations Director John E. Pickering of NASA OMSF discussed plans—approved by the Department of Agriculture; Department of Health, Education, and Welfare; and Department of Interior—for quarantine of the returned astronauts and lunar materials, and noted that the NASA Administrator or his designee would approve release of astronauts and lunar samples from quarantine on the advice and recommendations of the Interagency Committee on Back Contamination. Pickering also noted that “many of the problems concerning quarantine operations at the LRL were due to (1) lack of clearly defined responsibilities for the Medical Research and Operations and Science and Applications Directorates, (2) the lack of proven competence and maturity of the LRL staff, and (3) an integrated operational plan.” MSC Director of Science and Applications Wilmot N. Hess indicated that item (1) was resolved by a memorandum of understanding between MSC Director of Medical Research and Operations Charles A. Berry and himself but that MSC Director Robert R. Gilruth had not approved it. Hess also pointed out that an operational plan was being developed, but that LRL was primarily a scientific laboratory, not just a quarantine facility. This statement was disputed in view of the fact that the LRL was justified to Congress on the basis of a need for a quarantine facility.

18

Memo, V. R. Wilmarth, NASA Hq., to distr., “Conference on Lunar Sample Program,” Oct. 26, 1967.

MSC's Director of Engineering and Development Maxime A. Faget, at the request of the ASPO Manager, established a Configuration Control Panel (CCP) for government furnished equipment (GFE). The panel would integrate control of changes in the GFE items supplied for the Apollo spacecraft. “Authority to bring change recommendations to the GFE Panel will be invested in Division Chiefs. Changes rejected by the Division Chiefs need not be reviewed by the GFE CCP,” the memorandum establishing the panel said. Membership on the panel was as follows: Chairman, Maxime A.

18

1967
October Faget; Alternate Chairman, James A. Chamberlin; Members, Richard S. Johnston, Robert A. Gardiner, R. W. Sawyer (sic), and William C. Bradford. Secretary would be John B. See. (See also October 13.)

Memo, Faget to distr., "E&D/Apollo GFE Configuration Control Panel," Oct. 18, 1967.

20 In an effort to meet a mid-April 1968 delivery date for LM-3, Grumman made a number of organizational changes. Top level direction was strengthened by adding experienced managers in strategic positions and by reinforcing the Grumman LM organization with more management talent and additional test personnel. A spacecraft director for each vehicle was brought into the program for LM-2, -3, -4, and -5, with responsibility for overall Grumman support of individual vehicles from cradle to grave.

Ltr., L. J. Evans, Grumman Aircraft Engineering Corp., to G. M. Low, MSC, Oct. 20, 1967.

20 The SM reaction control system (RCS) for spacecraft 101 was criticized by C&SM RCS Subsystem Manager Ralph J. Taeuber. The results of the 101 RCS checkout, he said, "illustrate what we believe to be a lack of adequate workmanship and quality control during the manufacture and checkout of the RCS system. A total of 352 squawks have been written against the S/C 101 SM RCS and quad A has only been partially tested. This high number of discrepancies, most of which cannot be directly related to design deficiencies, is mute testimony to our contention. Test units of the RCS have been built at MSC from scratch with no significant problems either during manufacturing, checkout, or test firing. Thus we have demonstrated that the system can be built successfully even without the specialized equipment and facilities at NAA. Furthermore, NAA has fabricated a number of units with a minimum of discrepancies. . . ."

CSM Manager Kenneth S. Kleinknecht enclosed Taeuber's memorandum and a summary engine failure report written by McDonnell Douglas Corp. after completion of the Gemini program in an October 26 letter to North American Rockwell's Apollo CSM Program Manager Dale D. Myers. Kleinknecht pointed out: "Their conclusion that system contamination was the most likely source of failure in flight, coupled with the fact that the Mercury Program was also plagued with a similar problem, and added to the facts presented in the report by Mr. Ralph Taeuber leads me to believe that positive action must be taken to tighten up the quality control, both at North American Rockwell Corporation and at all subcontractors and vendors that supply the parts for the Apollo RCS. . . . Something must be done to consistently bring the contamination of this system down to an acceptable level. The numerous problems with corrosion and foreign matter are occurring so frequently that it is possible we have other quality or procedural failure modes that are hidden by the constant and over-riding failure modes associated with contamination."

Kleinknecht added that he expected to receive within two weeks a written notice from North American that it was implementing a plan for corrective

action and that the plan must include corrective action at the subcontractor and vendor levels.

1967

October

Myers advised Kleinknecht December 4 that, to determine the cause of the recent valve failures from internal contamination, North American Quality & Reliability Assurance had begun an accelerated investigation October 22. All RCS valve suppliers were investigated, and one supplier was found to have introduced an improper cleaning sequence on an assembled helium-isolation valve, resulting in trapped deionized water in the valve. Valves suspected of moisture contamination were removed from the RCS and, after the supplier corrected the irregularities in his cleaning operation, the valves were returned for rework under North American source inspection surveillance. At the plant of the sub-tier supplier responsible for cleaning the valves that failed on spacecraft 101, a North American source inspector was now required to review the supplier's shop planning and indicate product acceptance by witnessing and verifying newly inserted inspection points on the supplier's in-process paper work.

Myers said that, as pointed out in Kleinknecht's letter, "systems and component contamination were a serious quality and technical problem faced by all major space programs. To rationalize these problems as workmanship and inspection errors introduced the risk of creating misdirected effort that attacks the result instead of the cause.

"The investigation and remedial action taken on the helium valves was a logical and aggressive response to apparent quality problems and is directed toward correcting both the unsatisfactory condition and eliminating the factors that cause the condition to develop. Suspected hardware was immediately removed from the production cycle, inspection surveillance was increased at critical points in the process to insure against continuation of the problem, and a longer range program was implemented to provide extra assurance that similar problems do not exist or develop at other suppliers.

"The process control investigation that revealed the cause of trouble with the helium valve was being expanded to include a re-evaluation of all suppliers involved with cleaning valves, regulators, etc., used in the Apollo CSM. In addition to a fresh look at the suppliers fabrication and cleaning activities, the process evaluation is a comprehensive review of North American and supplier specifications for compatibility between the requirements for one assembly and the next, and a re-survey of the suppliers facilities to assure he has the technical capability and equipment to meet the stringent Apollo CSM quality requirements. The plan of action for this process study is being developed, and action to the plan will commence within a week."

Memo, Taeuber to S. H. Simpkinson, MSC, "S/C 101 SM RCS Checkout," Oct. 20, 1967; ltrs., Kleinknecht to Myers, Oct. 26, 1967; Myers to Kleinknecht, Dec. 4, 1967.

1967
October
28

The following ground rules were established for extravehicular activity planning. The EVA transfer would be demonstrated and thermal-degradation samples retrieved during the AS-503/103/LM-3 (Apollo 8) mission. No other pre-lunar-landing mission would include planned EVA exercises. The first lunar landing mission would be planned with two EVA excursions.

Memo, George M. Low to distr., "Mainline Apollo EVA Policy," Oct. 28, 1967.

28

Plans were to use 100-percent oxygen in the CSM cabin during prelaunch operations for manned flights but, since flammability tests of the CSM were not finished, the possibility existed that air might be used instead of pure oxygen. Therefore, contingency plans would be developed to use air in the cabin during the prelaunch operations so that a change would not delay the program.

Memo, G. M. Low, MSC, to R. O. Middleton, KSC, "Possible use of air in the CSM cabin during prelaunch operations," Oct. 28, 1967.

30

Confirming an October 27 telephone conversation, ASPO Manager George M. Low recommended to Apollo Program Director Samuel C. Phillips that the following LM delivery schedule be incorporated into official documentation: LM-2, February 5, 1968; LM-3, April 6, 1968; LM-4, June 6, 1968. Subsequent vehicles would be delivered on two-month centers. The dates had been provided by Grumman during the last Program Management Review.

Ltr., Low to Phillips, Oct. 30, 1967.

30

Actions on television cameras were reported by ASPO Manager George M. Low to Apollo Program Director Samuel C. Phillips:

- During the Apollo spacecraft redefinition effort, a decision was made to fly the Block I TV camera in the CSM and the Block II TV camera in the LM. It was also decided that the CSM onboard TV camera could not be used for monitoring hazardous tests.

- In recent weight-saving exercises, those decisions were reexamined and a conclusion was reached that no TV camera would be carried in the CSM. This would not only save four kilograms directly but would also reduce the required stowage space and reduce the overall weight by minimizing the number of required containers.

- A decision was made to stow the Block II TV camera in the descent stage during the lunar mission. There would still be a requirement for checking out the lunar TV camera in earth orbit to ensure that it would work on the lunar surface. For that reason, it was planned to carry the camera in the ascent stage on the LM-3 mission, and in the descent stage on subsequent vehicles.

Low said, "Our present plans for TV in Apollo spacecraft call for the use of facility cameras to monitor hazardous testing on the ground. There will not be any television equipment in the Command Module on any flight."

1967
October

Ltr., Low to Phillips, Oct. 30, 1967.

A parachute test (Apollo Drop Test 84-1) failed at El Centro, Calif. The parachute test vehicle (PTV) was dropped from a C-133A aircraft at an altitude of 9144 meters to test a new 5-meter drogue chute and to investigate late deployment of one of the three main chutes. Launch and drogue chute deployment occurred as planned, but about 1.5 seconds later both drogue chutes prematurely disconnected from the PTV. A backup emergency drogue chute installed in the test vehicle and designed to be deployed by ground command in the event of drogue chute failure also failed to operate. The PTV fell for about 43 seconds before the main chutes were deployed. Dynamic pressure at the time of chute deployment was estimated at about 1.2 newtons per square centimeter (1.7 pounds per square inch). All parachutes failed at or shortly after main parachute line stretch. The PTV struck the ground in the drop zone and was buried about 1.5 meters. An accident investigation board was formed at El Centro to survey mechanical components and structures, fabric components, and electrical and sequential systems. R. B. West, Earth Landing System Subsystem Manager, represented NASA in the investigation. It was determined that two primary failures had occurred: (1) failure of both drogue parachute-reefing systems immediately after deployment; and (2) failure of the ground-radio-commanded emergency-programmer parachute system to function.

30

On November 3, a preliminary analysis of the drop test failure was made at Downey Calif., with representatives of NASA, North American Rockwell, and Northrop participating. The failure of the drogue, being tested for the first time, was determined to be a result of the failure of the reefing ring attachment to the canopy skirt. The reason the ring attachment failed seemed to be lack of a good preflight load analysis and an error in the assumption used to determine the load capacity of the attachment. The failure of the deployment of the emergency system was still being investigated.

TWX, George M. Low to Director, Apollo Program Office, NASA Hq., Oct. 31, 1967; memos, Milton A Silveira to Kenneth S. Kleinknecht, "Failure which occurred on Apollo Drop Test 84-1," Oct. 31, 1967; "Further information on Apollo Drop Test 84-1 failure," Nov. 1, 1967; and "Results of Preliminary Analysis of Apollo Drop Test 84-1 Failure," Nov. 6, 1967.

Maxime A. Faget, MSC Director of Engineering and Development, told the ASPO Manager that he had reviewed the LM insulation status and concluded that "the present design is susceptible to degradation from cabin leakage during pressurized conditions. The present insulation design is unacceptable for the lunar landing mission." He agreed with the contractor that design changes were required and specified that the insulation design

November

2

1967
November

change should be effective on LM-4 and the changes should be installed for the LTA-8 tests in support of LM-5.

Memo, Faget to Manager, ASPO, "LM Insulation," Nov. 2, 1967.

3

A cooling design to keep heating effects of the radioisotope thermoelectric generator (RTG) below 450 kelvins (350°F) was being sought for the Apollo Lunar Surface Experiments Package. Studies had shown that the RTG could be a fire hazard when the ALSEP was carried in the lunar module, heating temperatures up to 590 kelvins (600°F) unless cooling was provided. Temperatures from 460 to 465 kelvins (370°F to 380°F) were hazardous with the fuels in the LM. (See also July 21, 1967, entry.)

Memo, George C. White, Jr., NASA Hq., to William M. Bland, Jr., MSC, "Failure Effects Analysis—LM/ALSEP Interface," Nov. 3, 1967.

3

A series of lunar surface operations planning meetings was scheduled to establish and coordinate operational requirements and constraints, review analysis and simulation data for lunar surface operations, review hardware status and requirements, review test and simulation planning, identify and resolve operational problems, obtain agreement on mission guidelines and recommended flight activities, and collect comments on the surface operations plans.

Memo, Donald K. Slayton, MSC, to distr., "Lunar Surface Operations Planning Meetings," Nov. 3, 1967.

November 3–
December 19

In an exchange of correspondence, KSC Director Kurt H. Debus and MSC Director Robert R. Gilruth agreed that close coordination was required between the two Centers regarding launch site recovery and rescue in the event of malfunction leading to an unsuccessful abort before or just after ignition during a launch phase. Coordinated recovery and rescue plans were being formulated for such an emergency. Plans would also include the Department of Defense Eastern Test Range and required coordination with DOD. On December 19 Debus was informed by NASA Hq. that his proposal for a slide wire emergency system had been reviewed and approved.

Ltrs., Debus to Gilruth, Nov. 3, 1967; Gilruth to Debus, Nov. 20, 1967; Gilruth to Samuel C. Phillips, NASA Hq., Nov. 16, 1967; Phillips to Debus, Dec. 19, 1967.

4

NASA announced an Apollo mission schedule calling for six flights in 1968 and five in 1969. NASA Associate Administrator for Manned Space Flight George E. Mueller said the schedule and alternative plans provided a schedule under which a limited number of Apollo command and service modules and lunar landing modules, configured for lunar landing might be launched on test flights toward the moon by the end of the decade. Apollo/uprated Saturn I flights were identified with a 200 series number; Saturn V flights were identified with a 500 series number. The 1968 schedule was:

- Apollo/Saturn 204—first unmanned test of the LM in earth orbit
- Apollo/Saturn 502—second unmanned flight test of the Saturn V and Apollo CSM
- Apollo/Saturn 503—third unmanned test of the Saturn V and Apollo CSM
- Apollo/Saturn 206—second unmanned flight test of LM in earth orbit
- Apollo/Saturn 205—first Apollo manned flight, a 10-day mission to qualify the CSM for further manned missions
- Apollo/Saturn 504—first manned Apollo flight on Saturn V. This mission would provide first manned operation in space with both the CSM and LM, including crew transfer from CSM to LM and rendezvous and docking.

1967
November

These flights would be flown in the above order and as rapidly as all necessary preparations could be completed.

The 1969 flight schedule called for five manned Apollo/Saturn V flights, AS-505 through AS-509. Four of these—505, 506, 507, and 508—were programmed as lunar mission development flights or lunar mission simulations. It was considered possible that the lunar landing could be made on Apollo/Saturn 509, but it was also possible this might be delayed until one of the remaining six Saturn V flights.

TWX, Ralph E. Gibson, Deputy News Chief, NASA Hq., to all NASA Centers and Stations, NASA News Release 67-282, "Apollo/Saturn Schedule," Nov. 4, 1967.

MSC Director Robert R. Gilruth, wrote Warren B. Hayes, President of Fansteel Metallurgical Corp., that planned schedules for the lunar landing training vehicle (LLTV) could not be maintained because of the need for refabrication of the hydrogen peroxide tanks. The tanks had been manufactured by Airtek Division of Fansteel under contract to Bell Aerosystems Co. Airtek's estimates were that the first of the new tanks would not be available until January 1968, two months later than required to meet the LLTV program schedule. Gilruth said: "The LLTV is a major and very necessary part of the crew training program for the lunar landing maneuver. It is my hope that Airtek will take every action to assure that the manufacturing cycle time for these tanks is held to an absolute minimum." In preparing background information for Gilruth, Flight Crew Operations Director Donald K. Slayton had pointed out that the first set of tanks (total of eight) had been scrapped because of below-minimum wall thickness. Qualification testing of a tank from the second set revealed out-of-tolerance mismatch of welded tank fittings, and this set was also scrapped.

7

Ltr., Gilruth to Hayes, Nov. 7, 1967; memo, Slayton to MSC Director, "Proposed letter to President, Fansteel Metallurgical Corporation," Nov. 3, 1967.

The MSC Director of Engineering and Development pointed out that a full-scale CSM would soon be tested to evaluate the hazard of fire propagation

8

1967
November

both in orbit (cabin atmosphere of oxygen at pressure of 3.8 newtons per square centimeter—5.5 pounds per square inch absolute) and on the pad (oxygen at 11.4 newtons per sq cm—16.5 psia). There was a reasonable probability that the CSM might qualify in the first but not the second case. In such event, it was proposed that the prelaunch cabin atmosphere be changed from 100-percent oxygen to a mixture of 60-percent oxygen and 40-percent helium or to a mixture of 60-percent oxygen and 40-percent nitrogen. This proposal was made on the assumption that those mixtures at 11.4 newtons per sq cm would not offer more of a fire hazard than 100-percent oxygen at 3.8 newtons. It was also assumed that these mixtures would be physiologically suitable after being bled down to orbital pressure without subsequent purging or being enriched with additional oxygen. Structures and Mechanics Division (SMD) was requested to make flammability tests to determine the relative merit of the two mixtures and to outline a minimum test program to provide confidence that the mixed gas atmosphere might be considered equivalent to oxygen at 3.8 newtons.

Memo, Maxime A. Faget to Chief, Structures and Mechanics Div., MSC, "Prelaunch atmosphere for Command Module," Nov. 8, 1967.

9

Apollo 4 (AS-501) was launched in the first all-up test of the Saturn V launch vehicle and also in a test of the CM heatshield. The Saturn V, used for the first time, carried a lunar module test article (LTA-10R) and a Block I command and service module (CSM 017) into orbit from KSC Launch Complex 39, Pad A, lifting off at 7:00:01 a.m. EST—one second later than planned. The launch was also the first use of Complex 39. The spacecraft landed 8 hours 37 minutes later in the primary recovery area in the Pacific Ocean, near Hawaii, about 14 kilometers from the planned point. CM, apex heatshield, and one main parachute were recovered by the carrier U.S.S. *Bennington*.

Main objectives of the mission were to demonstrate the structural and thermal integrity of the space vehicle and to verify adequacy of the Block II heatshield design for entry at lunar return conditions. These objectives were accomplished.

The S-IC stage cutoff occurred 2 minutes 30 seconds into the flight at an altitude of about 63 kilometers. The S-II stage ignition occurred at 2 minutes 32 seconds and the burn lasted 6 minutes 7 seconds, followed by the S-IVB stage ignition and burn of 2 minutes 25 seconds. This series of launch vehicle operations placed the S-IVB and spacecraft combination in an earth parking orbit with an apogee of about 187 kilometers and a perigee of 182 kilometers. After two orbits, which required about three hours, the S-IVB stage was reignited to place the spacecraft in a simulated lunar trajectory. This burn lasted five minutes. Some 10 minutes after completion of the S-IVB burn, the spacecraft and S-IVB stage were separated, and less than 2 minutes later the service propulsion subsystem was fired to raise the apogee. The spacecraft was placed in an attitude with the thickest side of the CM



A Navy helicopter hovers over spacecraft 017 awaiting the recovery ship after the *Apollo 4* (AS-501) mission—the first Saturn V flight—on November 9, 1967. Frogmen attached the flotation collar to the command module after splashdown. On arrival of the U.S.S. *Bennington*, CM 017 is hoisted aboard.

heatshield away from the solar vector. During this four-and-one-half-hour cold-soak period, the spacecraft coasted to its highest apogee—18 256.3 kilometers. A 70 mm still camera photographed the earth's surface every 10.6 seconds, taking 715 good-quality, high-resolution pictures.

About 8 hours 11 minutes after liftoff the service propulsion system was again ignited to increase the spacecraft inertial velocity and to simulate entry from a translunar mission. This burn lasted four and one half minutes. The planned entry velocity was 10.61 kilometers per second, while the actual velocity achieved was 10.70.

Recovery time of 2 hours 28 minutes was longer than anticipated, with the cause listed as sea conditions—2.4-meter swells.

MSC, "Apollo 4 Mission Report," Jan. 7, 1968; TWXs, W. C. Schneider, NASA Hq., to addressees, "Apollo 4 24-Hour Report," Nov. 10, 1967; R. O. Middleton, KSC, to addressees, "Apollo 4 Quick-Look Assessment Report," Nov. 13, 1967; Arthur Rudolph, MSFC, to addressees, "AS-501 Flight Results (10 day report)," Nov. 21, 1967; Saturn AS-501 Evaluation Bulletins No. 1 and No. 2, Nov. 14 and Nov. 22, 1967; NASA, "Apollo Program Weekly Status Report," Nov. 10, 1967.

Tests of sample constant-wear garments (underwear) fabricated from Beta fabric were reported as showing the garments were a source of excessive lint and irritated the skin. Efforts were being made to fabricate a knitted garment that would overcome these problems. Other flame resistant materials and flame retardant treatments were also being investigated. However, since delivery schedules of training and initial flight items required an immediate

1967
November

11

1967
November

decision concerning material selection, it was decided to use the original cotton undergarment configuration.

Memo, George M. Low, MSC, to Samuel C. Phillips, NASA Hq., "Constant wear garment," Nov. 11, 1967.

- 13** ASPO Manager George Low, in a memorandum to CSM Manager Kenneth Kleinknecht, remarked that he had "just read Dale Myers' letter to you . . . on the subject of Northrop Ventura performance. In addition I have . . . read a letter from Dick Horner to me in response to my letter . . . of September 29, 1967. Both of these letters have the same general tone: they indicate that problems did exist in the past, but that all problems have now been resolved. . . . I am still . . . uneasy about the Northrop Ventura situation. I would, therefore, recommend that you might personally want to visit the Northrop Ventura facilities so that you can, at first hand, inspect their plant, review their program and talk to their people. You might want to ask Eberhard Rees, Scott Simpkinson and Sam Beddingfield to join you on such a visit. I would hope . . . you would see fit to make this visit in the very near future so that any corrective actions that you might identify can be taken before the Spacecraft 101 parachutes are packed."

Memo, Low to Kleinknecht, "Parachutes," Nov. 13, 1967.

- 14** A full-time lunar landing training vehicle (LLTV) operating capability was essential to lunar landing training. Optimum proficiency for the critical lunar landing maneuver would be required at launch. Crew participation in the three months or more of concentrated checkout and training at KSC before each lunar mission, coupled with routine launch delays, would make KSC the preferred location for LLTV operating capability.

Ltrs., George E. Mueller, NASA Hq., to Robert R. Gilruth, MSC, Nov. 14, 1967 and Dec. 16, 1967; TWX, Maynard E. White, NASA Hq., to MSC and KSC, "Lunar Landing Training Vehicle," Nov. 20, 1967.

- 14** In a letter to North American Rockwell and Grumman management, ASPO Manager George Low pointed out that he had taken a number of steps to strengthen the Configuration Control Board (CCB) activities and said he felt it was "very desirable to have senior management from NAR and GAEC present for our Board meetings." The meetings were held each Friday. North American Apollo CSM Manager Dale D. Myers replied on November 17 that he, Charles Feltz, or George Jeffs would attend the meetings on an alternate schedule. Myers informed Low that North American was implementing new requirements designed to strengthen its own CCB. MSC's Kenneth S. Kleinknecht had been invited to attend North American's weekly Tuesday meetings when possible and RASPO Manager Wilbur Gray was invited to attend routinely.

Ltrs., Low to Myers, Nov. 14, 1967; Myers to Low, Nov. 17, 1967.

MSC informed MSFC that it would provide the following payload flight hardware for the AS-503/BP-30 flight test: boilerplate 30 (BP-30, already at MSFC); spacecraft-LM adapter 101 and launch escape system (SLA-101/LES) jettisonable mass simulation; and lunar module test article B (LTA-B, already at MSFC). MSC had no mission requirements but recommended that any restart test requirements for the Saturn SIV-B stage be carried out on this mission to simplify requirements for the first manned Saturn V mission.

1967

November

15

Ltr., George M. Low to Arthur Rudolph, MSFC, "AS-503/BP-30 flight test," Nov. 15, 1967.

Spacecraft 017 (recovered after flight on the *Apollo 4* mission) arrived in Downey, Calif., and was inspected by Robert R. Gilruth, George M. Low and others from MSC. Its condition was much better than anticipated, considering the severe heating it had been subjected to. Maximum erosion was between 2.5 and 7.6 millimeters.

15

"MSC Weekly Activity Report for Mr. Webb," week ending Nov. 17, 1967.

MSC Flight Operations Directorate issued mission rules concerning beach impact for the *Apollo 7* mission. The Directorate referred to minutes of the Near-Pad Abort Meeting, dated September 26, which said the possibility of injury to the crew should it impact on land near Complex 34 necessitated mission rules prohibiting spacecraft launch in wind conditions that would cause a land impact after an abort. A satisfactory means of escape "must be provided to the crew while in the spacecraft during pad tests when wind conditions prohibit pad aborts due to possible beach impact." Mission rules developed were: (1) An integrated launch abort trajectory would be conducted at MSC before the launch, using the actual measured launch-day wind profile for computing impact points. (2) Spacecraft launch would not be attempted if beach impacts were predicted before 15 seconds ground elapsed time (GET). (3) Launch would be permitted for predicted beach impacts occurring after 15 seconds GET provided the total time that the impact point was on land was no greater than 5 seconds. (4) If the wind conditions became marginal during countdown before the flight crew entered the spacecraft and if weather predictions indicated that the beach impact constraints would be violated at planned liftoff time, crew entry would be delayed until wind measurements indicated a trend that would allow a safe launch. And (5) if at any time after flight crew entry the measured wind conditions indicated a beach impact for a pad abort, the access arm would not be retracted until after the winds were determined to be safe as confirmed by a balloon release.

16

Memo, Christopher C. Kraft, Jr., to Manager, ASPO, "Mission Rules concerning predicted beach impact for the Spacecraft 101 launch," Nov. 16, 1967; telecon with Charles Harlan, MSC Flight Control Div., by Ivan Ertel, Aug. 31, 1970.

Robert R. Gilruth, George M. Low, and Maxime A. Faget, with other MSC personnel and North American Rockwell management officials visited AiResearch to review the status of the *Apollo* environmental control unit

16

1967
November

electronic components. There had been serious concern about AiResearch capabilities in this area. The review indicated that AiResearch circuit designs were satisfactory; that the electronic parts used were not satisfactory, but that substitutions of high-reliability parts could be made; and that AiResearch's capability in the manufacture of electronic components was substandard insofar as the aerospace industry was concerned. AiResearch was directed to obtain a subcontractor to build the most critical electronic controller in accordance with AiResearch designs and parts lists. All other electronic components were still under review and additional ones might be added to the backup contractor at a later date.

"MSC Weekly Activity Report for Mr. Webb," week ending Nov. 17, 1967.

- 17 An MSC meeting discussed environmental acceptance testing of Apollo spacecraft at the vehicle level. The meeting was attended by representatives of OMSF, MSC, and General Electric. Lad Warzecha presented results of a GE analysis of ground- and flight-test failures in a number of spacecraft programs. GE had concluded that a significant number of failures could be eliminated through complete vehicle environmental (vibration and thermal vacuum) acceptance testing and recommended such testing be included in the CSM and LM programs. James A. Chamberlin, MSC, presented a critique of the GE recommendations and found fault with the statistical approach to the GE analysis, indicating that each flight failure would have to be considered individually to reach valid conclusions. After considerable discussion ASPO Manager George M. Low said that he had reached the following conclusions: (1) Adequate environmental screening at the piece part and component level was essential. Significant steps in this direction had been taken by requiring a wider use of high-reliability parts and by imposing higher vibration levels in black box acceptance testing. (2) Vehicle-level environmental acceptance testing was not applicable to the CSM or LM spacecraft. This conclusion was reached because it was not possible to vibrate, or otherwise excite, any of the Apollo spacecraft in a way to give meaningful vibration levels at most internal spacecraft locations.

Memo for the Record, Low, Manager, ASPO, "Apollo complete vehicle environmental acceptance testing," Nov. 18, 1967.

- 17 Eberhard F. M. Rees of MSFC sent MSC ASPO Manager George M. Low the results of a brief survey he had made at North American Rockwell. This was a preliminary step to plans agreed on by NASA Administrator James E. Webb, Associate Administrator for Manned Space Flight George E. Mueller, MSFC Director Wernher von Braun, MSC Director Robert R. Gilruth, and Low. Rees was to head a special task group, to be stationed at Downey and concerned largely with planning control and feedback; engineering, development, and design; manufacturing and assembly, manufacturing methods, and process control; quality assurance and reliability; and procedures, configuration control, etc.

1967
November

Rees recalled that his assignment, as spelled out by Webb, was mainly to support MSC on manufacturing problems. Accompanying Rees on the survey trip from October 24 to November 3 were Jerald R. Kubat of the Apollo Program Office, NASA Hq., and two MSFC associates of Rees, Jack Trott and E. D. Mohlere. Rees met with RASPO Manager Wilbur H. Gray and ASPO CSM Manager Kenneth S. Kleinknecht and with top North American officials. Discussions were held with RASPO personnel on configuration control, quality assurance, manufacturing problems, and the environmental control system in preparation for a trip to AiResearch. "Finally we reviewed the so-called Problem Assessment Room of NAR."

Before offering some recommendations for consideration, Rees pointed up a need for a considerably intensified program of subcontractor penetration and quality review, to include in-process inspections in critical processes or in assembly of critical components. He recommended that (1) he lead the task team, reporting to Kleinknecht since he felt the team should support and not only advise and consult; (2) all actions be executed with the contractor by RASPO; (3) the size of the group be 20 to 25 persons and the task length about six months; and (4) the team not involve itself in any design activities or new "inventions," but see to it that all problems be made visible and resolved according to the time schedule with follow-up actions and feedback.

Rees also listed a number of areas of possible improvement, among which were:

"Intensified exploration looking toward modularization in order to reduce impact of restricted work conditions in the capsule, although, according to my opinion, NAR has already taken steps in the proper direction and made improvement."

"Development of highly responsive communications system that will permit immediate revelation to management of manufacturing anomalies discovered on the shop floor."

"NAR quality control was, in my opinion, somewhat erratic. In some cases, jobs were over-covered, in others, coverage was missing."

"Returning to the matter of the communication link between shop and responsive levels of management, two examples will serve to illustrate the point. The S/C 101-RCS [reaction control system] quarter panel fastener hole mismatch was initially reported on January 9 within a shop loop. It did not get management attention until late October. Impact on other S/C requires attention. Again, the S/C 020 heat shield required grinding to remove interference with the umbilical. This, too apparently applied to other spacecraft. . . ."

Speaking of the field of controls and prompt display of problems, Rees said: "I feel that the so-called 'Problem Assessment Room' is a good beginning but that it requires much refinement. For example, it currently does not inform management of repetitive non-conformances or developing trends. Also, I learned that the previously mentioned improperly fitting RCS panel

1967
November did not show on the board. The reason given was that it was not displayed because no solution to the problem had yet been developed. It would appear to me that such a condition would eminently qualify a problem for display."

Memo, Rees to Low, "Brief Survey of CSM at NAR, Downey," Nov. 17, 1967.

20 Bell Aerosystems Co. informed MSC and NASA Hq. that the company had reached a point in the LM ascent engine program where it was confident that it would meet all commitments and requirements for the Apollo missions.

Ltrs., William G. Gisel, Bell Aerosystems Co., to Robert R. Gilruth and George M. Low, MSC, and Samuel C. Phillips, NASA Hq., Nov. 20, 1967.

20 MSC asked MSFC assistance in identifying and understanding any propellant sloshing effects that might create problems in the flight test program. The greatest uncertainty was associated with the techniques for passive thermal control in nonpowered flight.

Ltr., Robert R. Gilruth, MSC, to Wernher von Braun, MSFC, Nov. 20, 1967.

Week Ending
December
1

A meeting on LM testing was held at Grumman Aircraft Engineering Corp., with Robert R. Gilruth and George M. Low, MSC; George Hage, OMSF; Hilliard Paige, General Electric Co.; and George Stoner, Boeing Co., in addition to Grumman personnel. After NASA reviewed the LM vibration environment and previous acceptance test decisions, Grumman recommended that complete vehicle vibration testing with externally mounted acoustic horns should be continued beyond LM-2; that wider use of thermovacuum testing at the component level be considered; and that the LM designated for the lunar landing mission be subjected to complete thermovacuum tests either at MSC or KSC.

MSC concluded that (1) for schedule purposes it would plan to continue complete vehicle acoustic testing after LM-2; however, implementation of this decision would depend on the results of the LM-2 testing; (2) MSC would reexamine the application of more widespread thermal testing at the component level; and (3) the Grumman proposal to subject the LM designated for the lunar mission to more testing than earlier manned flights was unacceptable. Past experience had shown that earlier vehicles should always have more testing than later ones.

MSC, "Weekly Activity Report for Mr. Webb," week ending Dec. 1, 1967.

December
1

NASA Hq. requested MSC to forward by December 5 the Center's plan for providing qualified LM ascent engines with dynamically stable injectors for manned LM flights. The plan was expected to be based on ground rules established in July when a NASA team went to Bell Aerosystems Co. that the current BAC engine would be the prime effort with the Rocketdyne Division (North American Rockwell) injector development as backup. Headquarters

asked that the plan contain the following elements: (1) effectivity of Bell-improved design in LM; (2) earliest phaseout of Rocketdyne program, assuming satisfactory completion of BAC program; and (3) effectivity of backup Rocketdyne design in LM if the BAC effort was not successful.

1967
December

TWX, Samuel C. Phillips, OMSF, to MSC, Dec. 1, 1967.

NASA Hq. announced that, as concurred in by the Center Apollo Program Managers, the following decisions, based on the results of the *Apollo 4* mission, were firmly established:

1

- CSM 020 would be flown on the Apollo 6 mission.
- Boilerplate 30 was assigned to the AS-503 unmanned mission.
- If Apollo 6 was successful, AS-503 would be flown as the first Saturn V manned mission.

TWX, NASA Hq. to MSC, MSFC, and KSC, "Apollo 6 and AS-503 Unmanned CSM Assignments," Dec. 1, 1967.

NASA Administrator James E. Webb approved the designation "Saturn IB" as the standard way of referring to that launch vehicle in public statements, congressional testimony, and similar materials, rather than "Uprated Saturn I."

2

Memo, Associate Deputy Administrator Willis H. Shapley to distr., "Saturn IB Nomenclature," Dec. 2, 1967.

Walter J. Kapryan of the MSC Resident ASPO at KSC told the KSC Apollo Program Manager that one of the primary test objectives of the SM-102 static-fire test was to determine system deterioration caused by the static-fire sequence and exposure to residual hypergolics trapped in the system during subsequent prelaunch operations. He said it was imperative that the objective be met before the planned static-firing test of the SM-101. MSC requested that every effort be made to make the SM-102 test as soon as possible to ensure a representative time for subsequent storage and that a contractor tear-down inspection could be made to assess the advisability of static-firing the flight spacecraft. A firing date of January 15, 1968, would accomplish those objectives.

5

Memo, Kapryan to Apollo Program Manager, KSC, "SM-102 Static Fire Schedule," Dec. 5, 1967.

Astronaut Charles (Pete) Conrad's concern about an anticipated attitude control problem in the LM was reported. Conrad had said, "The LM is too sporty when in a light weight configuration." Minimum impulse was expected to produce about 0.3 degree per second rate, which was estimated to be about four times too fast. A memo on the problem possibility was written by Howard W. Tindall, Jr., Deputy Chief of MSC's Mission Planning and

7

1967
December

Analysis Division, to stimulate thinking. On December 9, ASPO Manager George M. Low asked Donald K. Slayton and Warren J. North if there was any chance of setting up a simulation to see whether this was a real concern.

Memo, Tindall to distr., "Light weight LM attitude control is too sporty," Dec. 7, 1967.

- 8 An Apollo drop test failed at El Centro, Calif. The two-drogue verification test had been planned to provide confidence in the drogue chute design (using a weighted bomb) before repeating the parachute test vehicle (PTV) test. Preliminary information indicated that in the test one drogue entangled with the other during deployment and that only one drogue inflated. The failure appeared to be related to a test deployment method rather than to drogue design. The test vehicle was successfully recovered by a USAF recovery parachute—intact and reusable.

TWX, George M. Low, MSC, to Director, Apollo Program Office, NASA Hq., Dec. 8, 1967.

- 9 MSC ASPO Manager George M. Low reminded NASA Apollo Program Director Samuel C. Phillips that at a meeting three weeks previous MSC had presented a Bell Aerospace Corp. qualification completion date for the LM ascent engine of March 28, and a Rocketdyne Division, North American Rockwell, completion by May 1, 1968. MSC at that time had expressed confidence that the Rocketdyne program could be accelerated to be completed in mid-March and be competitive to the BAC date, permitting a selection to install the best engine on LM-3.

During the interim, program reviews had been conducted at both Bell and Rocketdyne. The Bell program had been accelerated to complete qualification by February 9, 1968, by conducting qualification and design verification testing in parallel. While a greater risk would be incurred, both Grumman and NASA agreed to the procedure to expedite the Bell program. The Rocketdyne program could not be accelerated to complete qualification by February because of an uncertainty as to the performance of its engine, but qualification testing was expected to be completed by March. Anticipating that the only change would be a pattern modification, Rocketdyne was already manufacturing injectors to support an accelerated program.

Ltr., Low to Phillips, "Ascent engine program plan," Dec. 9, 1967.

- 11 NASA Hq. asked further MSFC studies of one of the most critical phases during an Apollo mission, the period between holddown arm release and launch umbilical tower clearance. Failures or incompatibilities that could cause a vehicle collision with ground equipment or a pad fallback were major elements of potential danger. Problems during that phase would be difficult to cope with from a crew safety or an abort point of view and also posed the double jeopardy possibility of losing both the space vehicle and mobile launcher.

1967
December

A number of studies had been made at MSFC of certain aspects of the problem, particularly postliftoff flight dynamics, the effects of winds, etc. Those studies had brought out the catastrophic potential of near-pad engine-out and actuator-hardover failures. NASA Hq. now asked MSFC to investigate further, with assistance of other Centers as required, the inadvertent system operation and component failures that could affect (1) a first-stage cutoff between holddown arm release and time of separation of the last physical connection between the vehicle and ground complex; (2) inadvertent critical operation or inhibition of such space vehicle systems as the emergency detection subsystem, guidance and control, electrical, and range safety during the same critical period; and (3) a premature or out-of-sequence liftoff.

The MSFC task leaders were asked to report findings to a panel made up of the MSFC, MSC, and KSC Apollo Program Managers and NASA Apollo Program Director Samuel C. Phillips before the flight readiness reviews for Apollo 5 and 6, scheduled for January 3 and mid-January 1968.

Ltr., Phillips to MSFC, "Apollo Lift-off Hazards," Dec. 11, 1967.

The phase I customer acceptance readiness review (CARR) of CM 101 was held at North American Rockwell in Downey, Calif. MSC's CSM Manager Kenneth S. Kleinknecht chaired the meeting, and SC 101 Manager John Healey represented North American. The review was the first of a three-phase CARR system initiated by North American. A total of 44 customer acceptance review item dispositions (CARIDs) were presented to the board and 13 were closed. The spacecraft was accepted for turnover to Apollo Test Operations pending submission of data to close the remainder. The majority of open CARIDs were for completing documentation for engineering orders, operation checkout procedures, and photography, with both North American and MSC having action item for closing out CARIDs. Five CARIDs made reference to flammability of material. The most significant item was the installation of 27.4 meters of coaxial cable in the spacecraft that did not meet flammability guidelines.

12

Memo, W. C. Brubaker, Bellcomm, Inc., to distr., "Trip Report—Phase I Customer Acceptance Readiness Review of SCM 101—Case 320," Dec. 29, 1967.

Apollo Program Director Samuel C. Phillips wrote to the three manned space flight Centers:

12

"I am sure that you are keenly aware of the importance of the forthcoming series of Apollo manned flights and the requirement that all responsible actions are taken to assure the success of each mission. To this end the Design Certification Review, established for manned flights, serves an important role. Shortly our program of progressive Design Certification Reviews leading to certification for the manned lunar landing will commence. A significant part of the effort requires a comprehensive supporting analysis of critical hardware to assure that all single failure

1967
December

points have been identified and accepted by all levels of Apollo Program management.

"I believe it necessary, therefore, that the Design Certification Review program formally record a listing of single failure points existing in flight and launch critical ground equipment which would cause crew or mission loss, together with a statement of rationale for accepting the risk of each of these single failure points. Establishing such a listing requires particular attention to commonality of ground rules and categorization such that the overall mission single failure point listing is an effective Design Certification Review input. While recognizing the present efforts existing at contractors and Centers in identifying single failure points, some additional work is required to obtain a consistent mission single failure point listing.

"It is requested that you initiate action to prepare for each Design Certification Review a single failure point listing which includes all considerations supporting the acceptance of each single failure point. This listing shall be prepared in accordance with ground rules established and coordinated by the Apollo Program Reliability and Quality Assurance Office, be approved by the Center, and shall be required 60 days in advance of the final Design Certification Review Board signoff."

Ltrs., Phillips to MSC, MSFC, and KSC, "Apollo Program Single Failure Points," Dec. 12, 1967.

14

Apollo Program Director Samuel C. Phillips wrote the manned space flight Centers of Apollo schedule decisions. In a September 20 meeting at MSC to review the Apollo test flight program, MSC had proposed a primary test flight plan including (1) the addition of a second unmanned LM flight, (2) addition of a third unmanned Saturn V flight, and (3) addition of a new primary mission, a lunar orbital mission. Phillips now wrote that decisions had been made to accommodate MSC's first two proposals into the mainline Apollo flight mission assignment. In addition, the proposal for the lunar orbital mission would be included in the Apollo flight mission assignments as an alternate to a landing mission.

Ltr., Phillips to Directors, MSC, MSFC, and KSC, "Apollo Spacecraft Flight Test Program Review/Apollo Mission Assignments," Dec. 14, 1967.

15

The Apollo Site Selection Board met at MSC and discussed landing ellipse topography, landing approach path topography, and operational considerations, among other topics. The board heard recommendations on landing sites for the first and second missions, and approved them subsequent to the meeting, and Apollo Program Director Samuel C. Phillips emphasized that three launch opportunities should be provided for all months of the year. Board members, in addition to Phillips, were James H. Turnock, John D. Stevenson, Charles W. Mathews, and Oran W. Nicks, all of NASA Hq.;

Owen E. Maynard and Wilmot N. Hess of MSC; Ernst Stuhlinger, MSFC; and R. O. Middleton, KSC.

1967

December

Memo, Apollo Program Director to distr., "Minutes of the Apollo Site Selection Board Meeting of December 15, 1967," Jan. 29, 1968.

Robert O. Piland, Technical Assistant to the MSC Director, reminded ASPO Manager George M. Low that some time previously Wilmot Hess, MSC, had requested incorporation of a camera on AS-502 to take photos of the earth from orbital altitudes. The camera would be the same kind as used on AS-501 but pictures would be taken from a height of 80 to 160 kilometers rather than from 16 000. Piland said he understood the mission would allow a strip of photography 160 kilometers wide across the southern part of the United States and Africa and would make a significant contribution to the initiation of an earth resources survey program. Low replied on December 20, "Our plans are to do this, assuming we can without schedule impact."

15

Memo, Piland to Low, "Photography on Mission 502," Dec. 15, 1967; note, Low to Piland, Dec. 20, 1967.

Top NASA and North American Rockwell management personnel discussed flammability problems associated with coax cables installed in CMs. It was determined that approximately 23 meters of flammable coax cable was in CM 101 and, when ignited with a nichrome wire, the cable would burn in oxygen at both 4.3 and 11.4 newtons per square centimeter (6.2 and 16.5 pounds per square inch). Burning rates varied from 30 to 305 centimeters per minute, depending upon the oxygen pressure and the direction of the flame front propagation. The cable was behind master display panels, along the top of the right-hand side of the cabin, vertically in the rear right-hand corner of the cabin, in the cabin feed-through area, and in the lower equipment bay. The group reviewed the detailed location of the cable, viewed movies of flammability tests, examined movies of the results of testing with fire breaks, discussed possible alternatives, and inspected cable installations in CMs 101 and 104.

16

The following alternatives were considered:

1. Replace all coax cable.
2. Wrap all coax cable with aluminum tape.
3. Partially wrap the cable to provide fire breaks. Tests at North American indicated that a 102-millimeter segment of wrapped cable with four layers of aluminum foil would provide a fire break. MSC tests indicated such a fire break was not adequate for multiple cables.
4. Leave the installation as it was.

The following factors were considered in reaching a decision for spacecraft 101:

1. The wiring in that spacecraft had been completed for several months. All subsystems had been installed and protective covers had been

1967
December

installed. Complete replacement or complete wrapping of all coax cables would be time consuming; it might take as long as three months, when taking retest into consideration. Additionally, in spite of extreme care, complete replacement or wrapping might do considerable damage to the installed wiring, and even partial wrapping might cause damage in many areas.

2. The coax cable could not self-ignite under any conditions.

3. In most installations, the coax cable was a separate bundle and not part of other wire bundles. An exception was the feed-through area in the lower right-hand corner of the cabin, where the coax cable was intertwined with other wires. Although power cables existed in this area, these were not high-current-carrying cables.

4. A minimum number of possible ignition sources existed in the vicinity of the coax cables, and a complex series of events would be required to ignite the cable.

In view of these factors, decisions for spacecraft 101 were:

1. The cable would be flown essentially as installed. The only exception was that the vertical cable bundle in the right-hand corner of the spacecraft would be wrapped with layers of aluminum tape. Each cable in this bundle would be individually wrapped.

2. An analysis by North American would document all other wiring near the coax cable, including the wire size, functions, maximum currents carried, and degree of circuit-breaker protection.

3. All possible ignition sources near the coax cable would be documented.

4. Tests would be made in boilerplate (BP) 1250 to determine the effects of fire breaks inherent in the installation.

In making these decisions, NASA and North American recognized that they were contrary to existing criteria and guidelines. Those present agreed that the decisions were an exception and in no way should be construed as a change or relaxation of the criteria and guidelines. The basic reason for the exception was summarized as follows: "As a result of the clean installation of the coax cables, the lack of external ignition sources, and the complete job done in cleaning up the spacecraft from the flammability viewpoint, the risk of igniting the coax cables is exceedingly small. This risk is believed to be less than would likely be incurred through possible damage to existing installations had a decision been made to replace or wrap the cables."

The installation in spacecraft 2TV-1 would not be changed. This decision was made fully recognizing that more flammable material remained in 2TV-1 than in 101. However, the burning rate of coax cable had been demonstrated as very slow, and it was reasoned that the crew would have sufficient time to make an emergency exit in the vacuum chamber from 2TV-1 long before any dangerous situations would be encountered.

Officials also agreed that coax cable in boilerplate 1224 would not be ignited until after the results of the BP 1250 tests had been reviewed.

1967
December

Memo for the Record, Manager, ASPO, "Command Module coax cable flammability considerations," Dec. 19, 1967.

A LM test failed in the Grumman ascent stage manufacturing plant December 17. A window in LM-5 shattered during its initial cabin pressurization test, designed to pressurize the cabin to 3.9 newtons per square centimeter (5.65 pounds per square inch). Both inner and outer windows and the plexiglass cover of the right-hand window shattered when the pressure reached 3.5 newtons per sq cm (5.1 psi). An MSC LM engineer and Corning Glass Co. engineers were investigating the damage and cause of failure.

17

TWX, ASPO Manager, MSC, to NASA Hq., Attn: Apollo Program Director, Dec. 19, 1967; "Activity Report—Quality Assurance," Bethpage, N.Y., Dec. 13-19, 1967.

NASA Associate Administrator for Manned Space Flight George E. Mueller informed MSC Director Robert R. Gilruth that he intended to establish a Guidance Software Task Force to determine whether any additional actions could be taken to improve the software development and verification process. He requested that MSC make a thorough presentation to the task force at its first meeting, to include flight software problem areas and also such matters as crew training, crew procedures development, mission planning activities, and the abort guidance system software. Mueller himself would chair the task force and other members would be: Richard H. Battin, Massachusetts Institute of Technology Instrumentation Laboratory; Leon R. Bush, Aerospace Corp.; Donald R. Hagner, Bellcomm, Inc.; Dick Hanrahan, IBM; James S. Martin, Jr., LaRC; John P. Mayer, MSC; Clarence Pitman, TRW; and Ludie G. Richard, MSFC.

18

Ltr., Mueller to Gilruth, Dec. 18, 1967.

NASA Administrator James E. Webb approved a reorganization of NASA Headquarters, making changes in OMSF. On January 26, 1968, Associate Administrator for Manned Space Flight George E. Mueller spelled out OMSF changes: (1) The Deputy Associate Administrator for Manned Space Flight would continue with "across the board" responsibility and act for Mueller when he was absent or not available; (2) the Deputy Associate Administrator for Manned Space Flight (Management) would be responsible for the supervision of all administrative aspects of management within the manned space flight organization; and (3) the Deputy Associate Administrator for Manned Space Flight (Technical) would be responsible as the technical director and chief engineer of the manned space flight programs.

18

Memo, Mueller to OMSF Employees, Jan. 26, 1968.

1967
December
19

NASA Hq. announced establishment of the Lunar Exploration Office within the Office of Manned Space Flight's Apollo Program Office. The new office, headed by Lee R. Scherer, merged program units directing Apollo lunar exploration and planning exploration beyond the first manned lunar landing. OMSF would staff the Systems Development element; the Lunar Science group would be staffed by the Office of Space Science and Applications, which would approve operating plans and scientific objectives, payloads, and principal investigators for specific missions.

NASA Special Announcement, "Establishment of an Apollo Lunar Exploration Organization within OMSF," Dec. 19, 1967; NASA News Release 68-5, Jan. 4, 1968.

20

As a part of the managers' technical status review, Dale Myers of North American Rockwell presented his analysis of fixes for the coax cable in spacecraft 103 and subsequent spacecraft. The North American recommendation was: (1) For spacecraft 103, 104, and 106—remove all coax and wrap with aluminum tape using a 75- to 90-percent overlap. Re-install wrapped coax with additional teflon overwrap in areas where chafing might occur. This wrapping would increase spacecraft weight by 0.9 kilograms. Schedule impact was estimated at five days for spacecraft 103 and 104 and one day for spacecraft 106. (2) For spacecraft 107 and subsequent spacecraft—install new coax cable that would meet nonmetallic-materials guidelines. There would be no schedule impact.

According to MSC's CSM Manager Kenneth S. Kleinknecht, the North American recommendation was justified for the following reasons:

1. All coax would be installed before the inspection process.
2. Spacecraft 106 was ready for electrical harness closeout; fabrication of new cables, with guideline material, would delay closeout by about three weeks.
3. The new cable to be used in spacecraft 107 was already used on the spacecraft upper deck, but had not been subjected to corrosive contaminants, oxygen, and humidity qualification. This qualification would be completed in line and before cable installation.
4. Although connectors used with coax on the upper deck were compatible with black boxes in the spacecraft and were supposedly available, there were not enough in stock to support the fabrication of new cables for spacecraft 103, 104, and 106.
5. Testing at North American and MSC supported the conclusion that wrapping with aluminum tape would preclude propagation of burning if ignition of the coax should occur.

Kleinknecht decided, with concurrence of Maxime A. Faget and Jerry W. Craig, to accept the proposal and Myers was authorized to proceed, subject to concurrence by Program Director Samuel C. Phillips and Program Manager George M. Low. Kleinknecht received oral concurrence from Low and Phillips on December 20; then, in confirming the decision with Myers,

he requested that North American develop a schedule recovery plan to negate the impact of the coax fix on spacecraft 103, 104, and 106.

1967

December

Memo, Kleinknecht to Low, "Command module coax cable decisions relative to spacecraft 103 and subsequent," Jan. 9, 1968.

ASPO Manager George M. Low pointed out to E. Z. Gray of Grumman that in October 1964 NASA had sent a letter to Grumman voicing concern over possible stress corrosion problems. The Grumman reply on October 30 of that year was unsatisfactory when considered in the light of stress corrosion cracks recently found in the LM aluminum structural members. Low asked what Grumman planned to do to make sure that no other potential stress corrosion problems existed in the LM and asked for a reply by January 1968 on how the problem would be attacked.

20

On December 21, Low wrote a similar letter to Dale D. Myers of North American Rockwell, reminding him of a letter sent by MSC in September 1964. He said that recent stress corrosion problems had been encountered in the LM and asked that North American make a detailed analysis to ensure that not a single stress corrosion problem existed in the CSM or associated equipment. Again, Low asked for a reply by January 15, 1968.

Ltrs., MSC to Grumman, "Contract NAS 9-1100, Stress Corrosion," Oct. 12, 1964; Grumman to MSC, "Stress Corrosion," Oct. 30, 1964; Low to Gray, Dec. 20, 1967; MSC to North American Aviation, "Contract NAS 9-150, Stress Corrosion," Sept. 17, 1964; Low to Myers, Dec. 21, 1967; TWX, North American Rockwell to MSC, "NAS 9-150, Stress Corrosion," Oct. 13, 1967.

A Lunar Mission Planning Board meeting was held at MSC with Julian M. West as acting chairman. Also present were Wilmot N. Hess, Christopher C. Kraft, Jr., Paul E. Purser, and Andre J. Meyer, Jr. (secretary); and invited participants Gus R. Babb, John M. Eggleston, and James J. Taylor. The meeting agenda involved two main subjects: (1) review of major meetings recently held involving lunar exploration and planning; and (2) review of the remote sensors for use in lunar orbit and payload available on the CSM during a manned landing mission for carrying remote sensing instrumentation. Hess, MSC Director of Science and Applications, reviewed the Group for Lunar Exploration Planning (GLEP) meeting in Washington December 8 and 9, which had examined potential sites for lunar exploration beyond Apollo based on scientific objectives and not operational considerations. He pointed out that during the GLEP group study at Santa Cruz, Calif., in the summer, scientists had strongly recommended a manned orbital mission be flown before manned landings, to gain additional photographic information for more effective mission planning and to make remote-sensing measurements to detect anomalies on the lunar surface. Hess said this position had changed to some extent.

21

Hess pointed out that lunar exploration was the responsibility of the new Lunar Exploration Office at NASA Hq. (see December 19). The office had further been subdivided into the Lunar Science Office, responsible for science and experiment planning, and the Flight Systems Office,

1967
December

responsible for modifications in the Apollo spacecraft to increase capability for developing advanced support systems such as mobility units and for developing the advanced ALSEP packages. Hess felt that dual launches, if conducted at all, would be carried out in the far distant future and therefore directed his group to select sites for nine single-launch missions, three of which should be planned without the aid of mobility and be limited to one-and-a-half kilometers; and the other six sites limited to five-kilometer maximum mobility radius.

Ground rules used in reduction of the proposed 39 lunar exploration sites were: (1) landing accuracy would be improved so the LM would land within a one-kilometer radius circle around the target point; (2) Lunar Orbiter high-resolution photography must cover any site considered; (3) science payload including mobility devices would be limited to 340 kilograms and (4) the lunar staytime would be limited to three days to include four extravehicular (EVA) periods totaling 24 hours. Hess mentioned new criteria which would affect mobility on the lunar surface. He said that MSC's Director for Flight Crew Operations Donald K. Slayton stated he would permit a single roving vehicle to go beyond walk-back distance if the vehicle had two seats so that both astronauts could simultaneously and if the unit carried two spare back-packs. Hess said, "This new criteria, however, would result in a roving vehicle weight of well over 227 kg when the back-packs were induced and thus could not be carried on a single launch mission."

MSC, "Minutes of the Lunar Mission Planning Board," Dec. 21, 1967.

- 21** Apollo Program Director Samuel C. Phillips told ASPO Manager George M. Low that a review had begun on the "Apollo Spacecraft Weight and Mission Performance Definition" report dated December 12 and that his letter indicated approval of certain changes either requested or implied by the report. Phillips added that his letter identified a second group of pending changes for which insufficient information was available. He stressed his serious concern over the problem of spacecraft weight growth and said weight must be limited to the basic 45 359-kilogram launch vehicle capability. "According to the progression established in your report, CM's 116 through 119 could exceed the parachute hand-weight capability. I would like to establish a single set of controlled basic weights for the production vehicles. For product improvement changes a good rule is a pound deleted for every pound added. For approved changes to the basic configuration, it is the responsibility of NASA to understand the weight and performance implication of the change and to establish appropriate new control values. . . ."

Ltr., Phillips to Low, Dec. 21, 1967.

- 22** The first fire-in-the-hole test was successfully completed at the White Sands Test Facility (WSTF). The vehicle test configuration was that of LM-2 and the test cell pressure immediately before the test was equivalent to a 68 850-

meter altitude. All test objectives were satisfied and video tapes of TV monitors were acquired. Test firing duration was 650 milliseconds with zero stage separation.

TWX, WSTF to MSC, Dec. 22, 1967.

1967
December

Bethpage RASPO Business Manager Frank X. Battersby met with Grumman Treasurer Pat Cherry on missing items of government property. The Government Accounting Office (GAO) had complained of inefficiency in Grumman property accountability records and had submitted a list of some 550 items of government property to Grumman. After nine weeks of searching, the company had found about 200 items. The auditors contended the missing items amounted to \$8 million-\$9 million. Cherry said he believed that all the material could be located within one week. Battersby agreed to the one-week period but emphasized that the real problem was not in locating the material but rather in establishing accurate records, since GAO felt that too often the contractor would be tempted to go out and buy replacement parts rather than look for the missing ones.

Week Ending
December
22

"Weekly Activity Report, Business Manager, RASPO Bethpage," week ending Dec. 22, 1967, to Chief, Apollo Procurement Br., Procurement and Contracts Div., MSC, Dec. 27, 1967.

CSM Manager Kenneth S. Kleinknecht asked the Manager of the Resident Apollo Spacecraft Program Office (RASPO) at Downey to inform North American Rockwell that MSC had found the suggestion that aluminum replace teflon for solder joint inserts and outer armor sleeves in Apollo spacecraft plumbing unacceptable because (1) the teflon insert was designed to give an interference fit to prevent the passage of solder balls into the plumbing; (2) an aluminum insert could not be designed with an interference fit for obvious reasons; (3) the aluminum insert was tested at the beginning of the program and found to be inferior to the teflon insert; and (4) the aluminum armor seal could not be used as a replacement for the outer armor sleeves because it did not eliminate the creep problem of solder.

27

Memo, Kleinknecht to Manager, RASPO, Downey, Calif., "NR solder joint suggestion," Dec. 27, 1967.

The LM ascent engine program plan submitted to NASA Hq. on December 9 had been approved, Apollo Program Director Samuel C. Phillips told ASPO Manager George M. Low. Phillips was concerned, however, about the impact of recent unstable injector tests at Bell Aerosystems Co. on this plan. He said, "Resolution of these failures must be expedited in order to maintain present schedules. Also of concern, is the possible underestimation of the contractual and integration problems that will exist if the Rocketdyne [Division] injector should be chosen." Phillips asked that those areas receive special attention and that he be kept informed on the progress of both injector programs.

28

TWX, Phillips to Low, Dec. 28, 1967.

- 1967**
December
28
- Confirming a discussion between George Low and Samuel Phillips on October 27, a decision was made to replace the glass windows in LM-1 with aluminum windows, as a precaution against a failure in flight similar to the one that occurred on LM-5 in testing.
- TWX, J. Vincze, LM-1 Vehicle Management Office, MSC, to NASA Hq., Attn: S. C. Phillips, "Replacement of windows on LM-1," Dec. 28, 1967.
- 1968**
January
2
- MSC called to the attention of North American Rockwell the number of discrepancies found at KSC that could have been found at Downey before hardware shipment. In an effort to reduce the discrepancies North American was requested to obtain and use the KSC receiving inspection criteria as a guide for shipping inspections. It was also suggested that the possibility of sending a few key inspectors to KSC for periods of three to six months to gain additional experience might be investigated.
- Ltr., Kenneth S. Kleinknecht, MSC, to Dale D. Myers, North American Rockwell, Jan. 2, 1968.
- 5**
- ASPO Manager George M. Low discussed with Rocco Petrone of KSC the problem of high humidity levels within the spacecraft-lunar module adapter. Petrone advised that several changes had been made to alleviate the problem: air conditioning in the SLA and the instrument unit would remain on during propellant loading; and the rate of air flow into the SLA was increased. Also, technicians at the Cape had designed a tygon tube to be installed to bring dry air into the LM descent engine bell, should this added precaution prove necessary. With these changes, Low felt confident that the humidity problem had been resolved.
- Memo for the Record, Low, "SLA humidity," Jan. 8, 1968.
- 5**
- Bellcomm engineers presented to NASA a proposed plan for lunar exploration during the period from the first lunar landing through the mid-1970s. The proposed program—based upon what the company termed "reasonable" assumptions concerning hardware capabilities, scientific objectives, launch rates, and relationships to other programs—was divided into four distinct phases: (1) an Apollo phase using existing vehicles, (2) a lunar exploration phase employing an extended LM with increased payload and longer staytime, (3) a lunar orbital survey and exploration phase using remote sensors and photographic equipment on a polar orbit flight, and (4) a lunar surface rendezvous and exploration phase using an unmanned LM to deposit the increased scientific equipment and expendables necessary to extend Apollo's manned lunar capability to two-week duration.
- N. W. Hinners et al., Bellcomm Technical Memo 68-1012-1, "A Lunar Exploration Program," Jan. 5, 1968.
- 5**
- Apollo Special Task Team (ASTT) Director Eberhard F. M. Rees, Martin L. Raines, and Ralph Taeuber of MSC, and J. McNamara, North American Rockwell, visited Rocketdyne Division to review the status of the LM ascent engine backup program. The presentation was made by Steve Domokos.

1968
January

The group was favorably impressed and felt that there was every indication that the Rocketdyne injectors would meet the LM requirements. ASTT recommended that MSC establish a board, chaired by the Chief of the Propulsion and Power Division and including one MSFC propulsion engineer, one MSFC manufacturing specialist, and other MSC personnel as required to provide a recommendation to ASPO of the ascent engine for LM-3.

Memo, Raines to Manager, ASPO, "Trip Report—Rocketdyne—January 5, 1968," Jan 8, 1968.

NASA Associate Administrator for Manned Space Flight George E. Mueller directed MSC Director Robert R. Gilruth to establish a task team to investigate why, in light of extreme precautions taken early in the program, the problem of stress corrosion in the LM was being encountered at such a late stage in Apollo. The problem, Mueller stressed, had been discovered at a most critical point in the program—the launch of the first LM was imminent and two subsequent vehicles were already well along in factory checkout. Any resultant slips in the LM program would seriously impact overall Apollo schedules. Gilruth replied he believed that such a team was not required. He affirmed that the reviews undertaken with the contractors in 1964 to guard against just these problems had proved inadequate when judged against present program demands. "The answer simply is that the job was not handled properly on the last go-round."

8

Ltrs., Mueller to Gilruth, Jan. 8, 1968; Gilruth to Mueller, Jan. 18, 1968.

George E. Mueller, NASA OMSF, in a letter to MSC Director Robert R. Gilruth, summarized a number of key Apollo program decisions required in order to emphasize the urgency of priority action in preparations necessary to certify the Apollo system design for manned flight. Mueller listed five items:

9

1. Assuming a successful flight of Apollo 5, the LM design must be certified ready for manned flight on AS-503.
2. A successful test firing of SM 102 at Cape Kennedy in January, in addition to the success of Apollo 4, would permit certification of the SM propulsion system for manned flight on AS-205.
3. A successful launch vehicle test of AS-502 (Apollo 6) would require that the Saturn V design be certified ready for manned flight by early April 1968.
4. A decision to certify the Block II CM design for manned flight should be essentially complete by early May 1968.
5. Launch Complex 34 design should be certified for manned flight no later than early June 1968.

Ltr., Mueller to Gilruth, Jan. 9, 1968.

Apollo Data Coordination Chief Howard W. Tindall, Jr., summarized mission planning for the first two hours on the lunar surface. That period,

11

1968
January

he said, would be devoted to checking out spacecraft systems and preparing for launch (in effect simulating the final two hours before liftoff). This procedure embodied several important benefits. As a pre-ascent simulation, it would afford an early indication of any problems in the checkout routine. More importantly, the initial checkout procedure would prepare the LM for takeoff at the end of the CSM's first revolution should some emergency situation require such an immediate flight abort.

Memo, Tindall to distr., "First 2 hours on the moon is a countdown to launch—simulated or real thing," Jan. 11, 1968.

- 11 A Parachute Test Vehicle (PTV) test failed at El Centro, Calif. The PTV was released from a B-52 aircraft at 15 240 meters and the drogue chute programmer was actuated by a static line connected to the aircraft. One drogue chute appeared to fail upon deployment, followed by failure of the second drogue seven seconds later. Disreefing of these drogues normally occurred at 8 seconds after deployment with disconnect at deployment at plus 18 seconds. The main chute programmer deployed and was effective for only 14 out of the expected 40 seconds' duration. This action was followed by normal deployment of one main parachute, which failed, followed by the second main parachute as programmed after four-tenths of a second, which also failed. The main chute failure was observed from the ground and the emergency parachute system deployment was commanded but also failed because of high dynamic pressure, allowing the PTV to impact and be destroyed. Investigation was under way and MSC personnel were en route to El Centro and Northrop-Ventura to determine the cause and to effect a solution.

TWX, George M. Low, MSC, to NASA Hq., Attn: Apollo Program Director, Jan. 11, 1968.

- 11 CSM Manager Kenneth S. Kleinknecht wrote his counterpart at North American Rockwell, Dale D. Myers, to express concern about NR's seeming inability to implement configuration control of flight hardware and ground support equipment. Some progress had been made recently, Kleinknecht observed, but many steps still had to be taken to achieve effective configuration management on the CSM. The MSC chief pointed especially to North American's inability to ensure that final hardware matched that set forth in engineering documents, a weakness inherent in the separate functions of manufacturing: planning, fabrication, assembly and rework. MSC recommended a check procedure of comparing part numbers of installed equipment to the "as designed" parts list. "In short," Kleinknecht concluded, "I think that we should tolerate no further delay in establishing a simple 'as built' versus 'as designed' checking function, beginning with and including the first manned spacecraft."

North American began a more nearly complete engineering order accountability system, which provided an acceptable method of verifying the "as designed" to the "as built" configuration of each spacecraft. This

system was planned to be applicable by the Flight Readiness Review on spacecraft 104 and on subsequent spacecraft at earlier points.

1968
January

Ltrs., Kleinknecht to Myers, Jan. 11, 1968; Myers to Kleinknecht, Feb. 13, 1968.

The Senior Flammability Review Board met at MSC with Chairman Robert R. Gilruth, George M. Low, Maxime A. Faget, Aleck C. Bond, Charles A. Berry, Donald K. Slayton, Christopher C. Kraft, Jr., Kenneth S. Kleinknecht, all of MSC, and George Jeffs of North American Rockwell participating. The meeting summary reported that a 60-percent-oxygen and 40-percent-nitrogen atmosphere was acceptable from a crew physiological standpoint. The requirement for crew prebreathing before launch was not dependent upon launching with the atmosphere. Operationally, the crew could remove their helmets and gloves following orbital insertion and verification of the integrity of the cabin and its environmental control system; oxygen leakage would be allowed to enrich the crew compartment atmosphere.

13

On January 25, Berry, MSC Director of Medical Research and Operations, wrote Gilruth: "We do not concur in the stated finding of the Board that a 60 per cent oxygen, 40 per cent nitrogen atmosphere is acceptable from a crew physiological standpoint. While it is true that a 60% oxygen, 40% nitrogen atmosphere at 5.6 psi [3.9 newtons per sq cm] should result in a cabin atmosphere physiologically equivalent to sea level conditions, this will not be the case in a spacecraft launched with a 60% oxygen, 40% nitrogen atmosphere to which no oxygen is added except by normal operation of the cabin regulator. Oxygen will be metabolized by the crew at a much greater rate than nitrogen will be leaking from the spacecraft. Assuming a case in which cabin relief valve seats at 6 psi [4.1 newtons per sq cm] and the cabin regulator does not begin adding oxygen until 4.8 psi [3.3 newtons per sq cm], the cabin atmosphere would then consist of approximately 49% oxygen. This is physiologically equivalent to a 12,000-foot [3700-meter] altitude in air. It would then take approximately 50 hours at the nominal cabin leak rate for the cabin regulator to enrich the mixture to a sea level equivalent."

"Senior Flammability Review Board Meeting," MSC, Jan. 13, 1968; memo, Berry to Gilruth, "Senior Flammability Review Board Meeting, January 13, 1968," Jan. 25, 1968.

ASPO Manager George M. Low outlined for the NASA Apollo Program Director MSC plans to static-fire the service propulsion system (SPS) as a complete unit. Houston officials maintained that at least one firing of such a complete system was necessary to prove the adequacy of all SPS manufacturing, assembly, and testing. However, because of several potential adverse effects that might accrue to testing the first such available system (that for the 101 SM), MSC proposed to test-fire the 102 unit and

13

1968
January

interpret those results—including any possible damage to the SM structure itself—before making a final decision on whether to proceed with a ground firing of the actual flight hardware before flight.

Memo, Low to NASA Hq., Attn: Samuel C. Phillips, "Requirements for static firing of Apollo service propulsion subsystem," Jan. 13, 1968.

- 15 George E. Mueller, NASA Associate Administrator for Manned Space Flight, summarized for Administrator James E. Webb recent program progress in Apollo. Preparations were under way toward the revised January 22 launch date for Apollo 5. Delays had resulted primarily from difficulties with hypergolic loading and contamination problems, but propellant loading had been completed several days earlier. Target for the countdown demonstration test was January 19. At Buffalo, N.Y., the NASA stability team assisted Bell Aerospace Co. in tackling the LM ascent engine instability problem. Post-test analysis of the qualification engine had revealed gouging of the chamber wall near the injector face. Bell engineers were assessing the amount of requalification testing that would be required and continued their testing on reworked engines, seeking to find the cause of previous engine instabilities. Meanwhile, the backup injector program at Rocketdyne Division was proceeding extremely well. Tests employing fuel film cooling had produced increased engine performance within acceptable chamber erosion limits. Altitude tests were scheduled to follow within a few weeks.

Memo, Mueller to Administrator and Deputy Administrator, "Manned Space Flight Report—January 15, 1968."

- 17 Eberhard Rees, Director of the Apollo Special Task Team at North American Rockwell's Downey plant, wrote ASPO Manager George Low outlining what he termed "serious quality and reliability resources deficiencies" and proposed several steps to bolster NASA's manpower in these areas. Specifically, Rees cited the immediate need for additional manpower (primarily through General Electric) to make vendor surveys, test failure assessments, and specification review and analysis and establish minimum inspection points. In addition, Rees said, many areas were almost totally lacking in coverage by the government, such as monitoring qualification tests, receiving inspections, pre-installation test, and many manufacturing operations. He urged Low to reassess his requirements in Houston to determine how many persons MSC might contribute (along with those from MSFC and GE) to plug these vital areas.

Ltr., Rees to Low, Jan. 17, 1968.

- 17 Eberhard Rees, Apollo Special Task Team chief at North American Rockwell, participated in a failure review at Northrop-Ventura of the recent parachute test failure (see January 11) and in development of a revised test plan. Others at the review included Dale Myers and Norman Ryker from North American and W. Gasich and W. Steyer, General Manager and Apollo Program Manager at Northrop-Ventura. Those at the review put

1968
January

together a revised drop test program that resulted in only a two-week schedule delay because of the failure. Repair of the parachute test vehicle was under way. Meantime, tests would continue, employing bomb and boilerplate devices. Also, Rees decided to establish a Flight Readiness Review Board (headed by Joseph Kotanchik of MSC) to approve each drop test, and Northrop officials had established an internal review board to review test engineering and planning and were tightening their inspection and quality control areas.

Memo, Rees to Manager, ASPO, "Trip Report to Northrop-Ventura on January 17, 1968," Jan. 19, 1968; ltr., Kenneth S. Kleinknecht, MSC, to Myers, Jan. 19, 1968.

A meeting was held at MSC to determine necessary action concerning recent contamination of CM 103's potable water, oxygen, and water-glycol lines. North American Rockwell proposed that all 103 aluminum lines in the potable water and oxygen systems (approximately 72 segments) be replaced; and proposed to follow a chemical flushing procedure for the water-glycol lines to remove the aluminum oxide and copper contamination. North American estimated that these actions would cause a 15-17 day serial impact. Removal and replacement of all lines would result in an estimated impact of 45 days. A decision was made to concur with the North American recommendation and on January 19 Kenneth S. Kleinknecht, MSC, informed Dale D. Myers, North American, of the concurrence and authorized him to proceed immediately. In addition, Kleinknecht appointed a Special Task Team for Spacecraft 103 Contamination Control to ensure timely review of all contractor activities associated with removal of the contamination from the spacecraft environmental control system coolant system. Members of the team were: Wilbur H. Gray, Chairman; A. M. Worden, W. R. Downs, Jack Cohen, A. W. Joslyn, R. E. Smylie, R. P. Burt, and W. H. Taylor.

18

On February 20 Myers notified Kleinknecht of initiation of the potable water line changes and setting up of a monitor water-glycol system that would duplicate CSM 103 operations during the balance of checkout and would be examined for corrosion damage just before Flight Readiness Review.

Memo, Manager, CSM, ASPO, to Manager, ASPO, "Meeting held to determine course of action regarding contamination of CM 103 plumbing," Jan. 19, 1968; ltr., Kleinknecht to Myers, Jan. 19, 1968; memo, Manager, CSM, ASPO, to distr., "Spacecraft Plumbing Contamination Control Board," Jan. 19, 1968; ltr., Myers to Kleinknecht, Feb. 20, 1968.

Rolf Lanzkron and Owen Morris, Chiefs of MSC's CSM and LM Project Engineering Divisions, led a review of the 2TV-1 and LTA-8 (thermal vacuum test article and lunar module test article) thermal vacuum test programs at MSC. Chief concerns expressed during the review centered on the heavy concentration of testing during the summer of 1968, the need for simultaneous operation of test chambers A and B, and the lack of adequately trained chamber operations support personnel for dual testing. The review disclosed that maintenance of testing schedules for LTA-8 was most

18-19

1968
January

unlikely, even with a seven-day-a-week work schedule. (The central problem was the large number of open items that had to be cleared before start of the tests.)

Note, C. C. Gay, Jr., to LeRoy Day, Jan. 19, 1968.

19

Apollo Program Director Samuel C. Phillips wrote ASPO Manager George M. Low requesting that he establish and maintain a detailed comparison of configuration differences between the CSM and LM. This comparison, Phillips said, should include major interface differences, subsystems and components, weight, performance, and crew safety. Phillips ordered this comparison chiefly because the Apollo spacecraft was entering an extremely important phase to certify the vehicles for manned flight.

Ltr., Phillips to Low, Jan. 19, 1968.

22

NASA launched *Apollo 5*—the first, unmanned LM flight—on a Saturn IB from KSC Launch Complex 37B at 5:48:08 p.m. EST. Mission objectives included verifying operation of the LM structure itself and its two primary propulsion systems, to evaluate LM staging, and to evaluate orbital performances of the S-IVB stage and instrument unit. Flight of the AS-204 launch vehicle went as planned, with nosecone (replacing the CSM) jettisoned and LM separating. Flight of LM-1 also went as planned up to the first descent propulsion engine firing. Because velocity increase did not build up as quickly as predicted, the LM guidance system shut the engine down after only four seconds of operation. Mission control personnel in Houston and supporting groups quickly analyzed the problem. They determined that the difficulty was one of guidance software only (and not a fault in hardware design) and pursued an alternate mission plan that ensured meeting the minimum requirements necessary to achieve the primary objectives of the mission. After mission completion at 2:45 a.m. EST January 23, LM stages were left in orbit to reenter the atmosphere later and disintegrate. Apollo program directors attributed success of the mission to careful preplanning of alternate ways to accomplish flight objectives in the face of unforeseen events.

Memo, Samuel C. Phillips to NASA Administrator, "Apollo 5 Mission (SA-204/LM-1) Post Launch Report #1," Feb. 12, 1968 (MOR M-932-68-05).

22

Joseph G. Gavin, Jr., LM Program Director at Grumman, advised ASPO Manager George M. Low of steps under way to attack the problem of stress corrosion in the LM. (Low had expressed MSC's concern over this potential danger on December 20, 1967.) While stating that he shared Low's concern, Gavin believed that stress corrosion would not prove to be of significance to the LM mission. However, his organization was prepared to reevaluate the LM's design and fabrication to determine to what extent the problem could be ameliorated. (Gavin denied that such metal corrosion could be absolutely eliminated using present materials as dictated by weight constraints on the LM design.) Gavin stated that he had created a special team of experienced

designers and stress analysts to review engineering design of every LM part sensitive to stress corrosion, to review processes employed in fabrication of the LM structure, and to review the adequacy of the company's quality control procedures to ensure corrosion-free parts and assemblies.

Ltr., Gavin to Low, Jan. 22, 1968.

Eberhard F. M. Rees, head of the Apollo Special Task Team at North American Rockwell, met with Kenneth S. Kleinknecht, MSC, and Martin L. Raines, Manager of the White Sands Test Facility, to review the team's recent operations and the responses of North American and its numerous subcontractors to the team's recommendations. Kleinknecht listed what he thought were the chief problems facing the CSM program: the S-band high-gain antenna (which he said should be turned over entirely to the task team for resolution); the parachute program; the environmental control system; and contamination inside the spacecraft. He urged that the team take the lead in developing solutions to these problems.

Memo for Record, Raines, "Review of Apollo Special Task Team Operations," Jan. 26, 1968.

The Apollo Mission Simulator, an astronaut training facility, in Building 5 at Manned Spacecraft Center. A similar facility was at Kennedy Space Center. Apollo crews spent hundreds of hours in the simulators, practicing all phases of the missions from liftoff through lunar landing, lunar exploration, and return. Simulators were updated for each mission. The men at the consoles at left, and others, worked with the astronauts and inserted unexpected problems into the training to assess astronaut response.

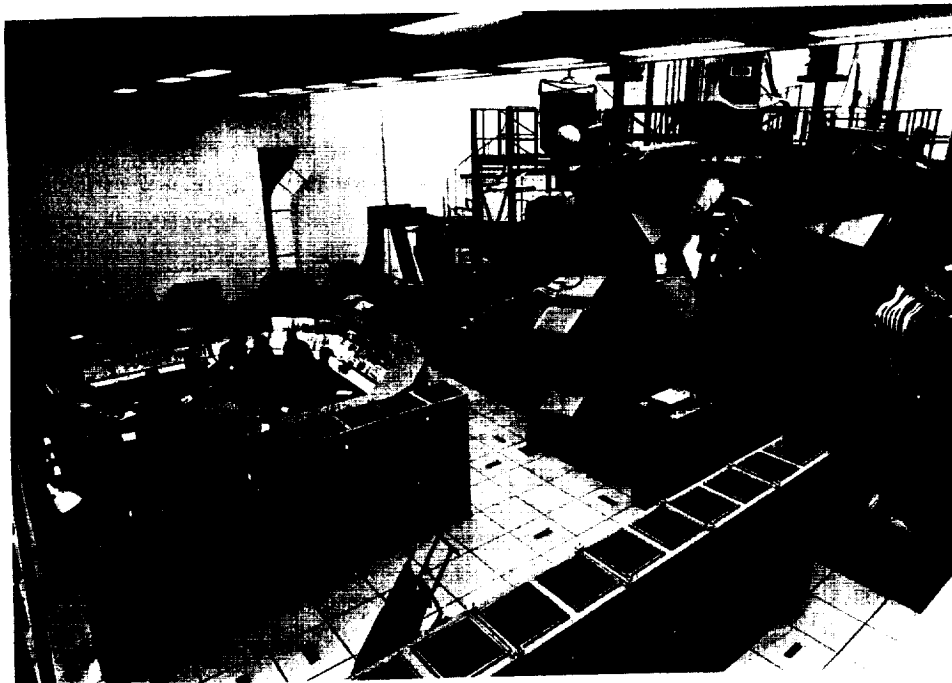

1968
January
25

In a letter to officials of the three manned space flight Centers, NASA Apollo Program Director Samuel C. Phillips called attention to the fact that as the time for the first manned Apollo flight was approaching constant concern for crew safety was becoming more pronounced. Phillips pointed out that the Crew Safety Panel, Flight Mechanics Panel, Launch Operations Panel, Hazardous Emergency Egress Working Group, and other Intercenter Coordination Panels had each dealt with specific aspects of Apollo crew safety. Individual Centers and contractors had exercised their crew safety responsibilities through system design, quality control, and test channels. Single-point failure analyses, dealing with specific hardware areas, had been made.

He said that these efforts had resulted in current provisions for rapid crew egress on the pad, for spacecraft abort during early phases of the launch, and for contingency flight modes. Phillips added, “. . . to insure that all of the many parts of the problem are properly integrated we should at this time step back and take another look at the overall crew safety picture from ingress to mission completion. The questions to be addressed are: (1) Have we systematically analyzed all likely failure modes or anomalies which could jeopardize the crew from ingress to mission completion? (2) In each of these cases do we have proper and timely cues coupled with a safe egress, abort, or contingency capability? (3) Do we have a plan for the timely solution of the known crew safety related problems? . . . I would like to have this essential area worked under leadership of MSC—focused at a high management level—with assistance as required from MSFC and KSC. . . .” In a reply to Phillips, on February 28, MSC’s George Low indicated that John Hodge had agreed to undertake the task and had already held discussions on the subject with George Hage of Phillips’ office.

Ltrs., Phillips to MSC, MSFC, and KSC, “Apollo Crew Safety Review,” Jan. 25, 1968; Low to Phillips, Feb. 28, 1968.

26

The Special Task Team for CSM 103, appointed January 18, submitted a progress report of activities during daily sessions held January 22 through 25. North American Rockwell and NASA had reached agreements on:

1. Cleaning and flushing of water management and oxygen systems. Since all aluminum lines except for three were replaced on CM 103 with new lines the resolution for cleaning and flushing these systems was quickly accomplished.
2. Cleaning and flushing of water glycol system.
 - a. Pressure integrity of the water glycol system would be confirmed by a hydrostatic check to 248 newtons per square centimeter (360 pounds per square inch). Leak integrity would be confirmed by subsequent checks with helium at 41 newtons per sq cm (60 psi).
 - b. A resolution was obtained on the chemistry of the various cleaning and flushing fluids to be used on CM 103.
 - c. Agreement was reached on verification of cleaning and flushing all flow paths.

The events leading to the situation on CSM 103 were reviewed in sufficient detail to make visible the errors in the discipline governing the flushing carts. RASPO Manager Wilbur H. Gray stated that it was the RASPO responsibility to ensure the upgrading and control of all such equipment which interfaced with the spacecraft. The team would convene again January 30 to review reports and continue with other activities required to ensure adequacy of the CSM 103 plumbing system.

1968
January

Memo, Gray to distr., "Summary of progress on the Special Task Team for CSM 103 Contamination Control," Jan. 26, 1968.

A LM-2 flight and requirement meeting was held at MSC, attended by key MSC and NASA Hq. officials. The group reached three conclusions: (1) The LM-1 performance on the January 22 *Apollo 5* mission had been excellent for all conditions of the flight, as executed, with the exception of minor anomalies. (2) The LM-2 flight objectives that were partially accomplished could be better accomplished by further ground testing or on subsequent manned missions. Further unmanned flight testing was not required for man-rating purposes. (3) A LM-2 flight was not required to man-rate the ascent engine injector. It was also agreed that a decision should be made not to fly the LM-2 mission, with this decision reversible if further evaluation of data from the LM-1 flight indicated any problems. This decision would be reviewed at the February 6 Manned Space Flight Management Council Meeting and on March 6 at the LM-3 Design Certification Review. The final decision would not be made until March 6.

26

Minutes of the LM-2 Flight Requirements Meeting, Jan. 26, 1968.

In response to a letter from ASPO Manager George M. Low in late December 1967, seeking assurances that no potential stress corrosion problems existed in the CSM, Dale D. Myers, CSM Program Manager at North American Rockwell, reviewed the three instances where problems had been encountered during the CSM project and iterated the extensive efforts to ensure against such potential problems. Echoing much the same words as his counterpart at Grumman, Myers stated that "it is not possible to guarantee that no single instance of stress corrosion will ever occur" and that circumstances "could create a problem not anticipated." He concluded that his company's efforts in this direction had been "entirely adequate and beyond the requirements of the contract and good practice in this industry," and he stated his belief that additional efforts in this area would not produce measurable results.

26

Ltr., Myers to Low, Jan. 26, 1968.

MSC CSM Manager Kenneth S. Kleinknecht, in a letter to North American Rockwell's Dale D. Myers, protested lack of North American response to written MSC direction concerning parachute test vehicles. Kleinknecht pointed out that MSC had "considerably modified our usual requirements in supporting the boilerplate 19 task being performed for you by Western

30

1968

January

Ways, Inc. These efforts seem to be completely negated by delayed go-ahead to Northrop Ventura for their portion of the task. I understand that neither Western Ways nor Northrop Ventura was given a go-ahead until January 19, 1968. The original written direction to NR [North American] was on November 9, 1967, to provide another parachute test vehicle (PTV) and give us an estimate of cost and schedule for another boilerplate PTV." If the effort on the PTV had started at that time, "we would now be able to use that vehicle rather than the bomb-type vehicles after losing PTV No. 2. The cost and schedule for boilerplate 19 was not submitted to MSC until later, on December 22, asking for a reply by January 2, 1968. Because of the holiday period, this written reply was furnished on January 5, after an investigation of the cost and schedule. The Engineering Change Proposal [ECP] stated a completion date of May 5; however, after a request by my people to see what could be done to improve this date, the improvement moved the Northrop Ventura schedule from June 14 to May 24 [a Friday]. This date is three weeks later than the date cited in the ECP and is completely unacceptable. . . ." On February 29, Myers assured Kleinknecht that North American had proceeded with the BP-19A task in advance of NASA full coverage. Initial partial coverage was issued to North American on January 5, 1968. On March 14, in a letter of commendation, Kleinknecht thanked Myers for the attention given the BP-19A effort that made a March 15 completion by Western Ways possible. On May 27, W. H. Gray, RASPO Manager, wrote another letter of commendation thanking North American for completing BP-19A in time for a drop test in May 1968.

Ltrs., Kleinknecht to Myers, Jan. 30, 1968; Myers to Kleinknecht, Feb. 29, 1968; Kleinknecht to Myers, Mar. 14, 1968; Gray to Drucker, May 27, 1968.

February

2

Eberhard F. M. Rees, Apollo Special Task Team Director at North American Rockwell, reported to ASPO Manager George M. Low on the need for audits of equipment supplied from vendors to the spacecraft contractor. Significant hardware failures and nonconformances had been discovered after delivery of equipment from the vendors to Downey, Rees stated, and NASA must take strong steps to upgrade the quality of workmanship at the vendors' locations.

Ltr., Rees to Low, Feb. 2, 1968.

3

ASPO Manager George M. Low advised Apollo Program Director Samuel C. Phillips that, in accordance with an action item resulting from the spacecraft environmental testing review at MSFC on January 10, he was reexamining the design, fabrication, and inspection of all interconnecting systems of the spacecraft to determine what further steps might be taken to ensure the integrity of those systems. Low had requested William Mrazek of MSFC to direct this effort, using a small task team to review the design of all spacecraft wiring and plumbing systems, their fabrication, and quality assurance and inspection techniques.

Ltr., Low to Phillips, Feb. 3, 1968.

A Senior Flammability Review Board meeting at MSC reached a number of decisions on the CSM. Attending were Robert R. Gilruth, chairman; George M. Low, Kenneth S. Kleinknecht, Aleck C. Bond, Maxime A. Faget, Donald K. Slayton, Charles A. Berry, and Rodney G. Rose, all of MSC; Samuel C. Phillips, NASA Hq.; William B. Bergen and Dale D. Myers, North American Rockwell; and George Stoner, Boeing (nonvoting observer).

Several previous action assignments were reviewed: (1) Component level Flammability Test Program—North American reviewed the results of its material identification and test program, the component test program, and the boilerplate 1250 tests. These tests had provided the basis for design decisions on selection and application of CM nonmetallic materials. (2) Boilerplate 1224 configuration comparison to CSMs 2TV-1 and 101—North American presented the comparison and the Board decided that the boilerplate configuration was representative of the "worst case" configuration, considering both 2TV-1 and 101. (3) Internal ignition rationale—Ignition rationale for the boilerplate 1224 tests was presented to the Board. Nichrome wire ignitors were used with the ignitor wire embedded in potting. In some locations a Ladicote cover was applied over the potting and ignitor. The Board pointed out that the ignition techniques were not really representative of actual operating conditions and were indeed overly severe. (4) Crew communications umbilical—North American was evaluating a fluorel crew communications umbilical as well as fluorel oxygen umbilicals. A Beta sleeve over the oxygen and crew communications umbilicals would also be evaluated for its operational acceptability by the crew.

The Board presented a review of test results. In the tests at pressure of 4.3 newtons per square centimeter (6.2 pounds per square inch) in a 95-percent-oxygen atmosphere, there were 38 ignitions in boilerplate 1224. Of these, 5 produced fires large enough to require further consideration. In tests at 11.2 newtons per sq cm (16.2 psia) in a 60-percent-oxygen and 40-percent-nitrogen atmosphere, there were 31 ignitions. Of these, 4 produced fires large enough to require further consideration.

The Board concluded that the material changes made in the CM had resulted in a safe configuration in both the tested atmospheres. The Board agreed "that there will always be a degree of risk associated with manned space flight," but the risk of fire "was now substantially less than the basic risks inherent in manned space flight."

Among decisions reached were: (1) the CSM 2TV-1 and 101 coaxial cable configuration would be tested in the 60-percent-oxygen and 40-percent-nitrogen atmosphere; (2) material improvements and testing would be continued and changes would be phased in, pending the availability of proved materials; and (3) action would be taken to be prepared to use a 60-percent-oxygen and 40-percent-nitrogen prelaunch atmosphere in CSM

1968
February

101. A final decision would be made at the Design Certification Review on March 7.

Minutes of the "Senior Flammability Review Board Meeting, Building 2—Room 966, February 5, 1968," sgd. Robert R. Gilruth, Feb. 23, 1968.

- 5 Homer E. Newell, NASA Associate Administrator, told MSC Director Robert R. Gilruth that at the last meeting of the Lunar and Planetary Missions Board the subject of astronaut activity on the lunar surface had been taken into consideration. The following motion had been generally endorsed by all members of the Board but tabled for formal action with the request that comments of the Flight Crew Operations Directorate be made on the motion and returned to the Board for further consideration: "It is proposed that during lunar EVA it be regarded as general practice and a requirement on the astronauts to utilize fully the voice channel from them to each other and to earth. What is intended is almost incessant talking, describing all actions and thoughts as they occur, but without devoting much additional concentration or interrupting any actions for that purpose. Such talk will have the advantage of increasing the information available should any hazardous situation arise, and therefore increase crew safety; secondly, it will be a major source of information of scientific importance, and the record of such talk will be most helpful to the astronauts themselves as well as others to re-enact the activities later and so better understand the record and the observations obtained."

The MSC Director of Flight Operations prepared an information staff paper for Gilruth that said the proposal had been evaluated by the Directorate, and the "marginal utility to be gained by such a practice is questionable" because "constant talking would involve a real time process of separating significant data from trivia." The Flight Operations Directorate "does not believe that crew safety will be enhanced by constant talking. . . . In summary . . . our present astronaut talking requirements are sufficient to satisfy the scientific world and provide sound operational support. . . ."

Ltr., Newell to Gilruth, Feb. 5, 1968; Information Staff Paper No. 99 to Director, MSC, from Director of Flight Operations, "Lunar EVA Procedures," Apr. 16, 1968.

- 8 Grumman President L. J. Evans wrote ASPO Manager George M. Low stating his agreement with NASA's decision to forego a second unmanned LM flight using LM-2. (Grumman's new position—the company had earlier strongly urged such a second flight—was reached after discussions with Low and LM Manager C. H. Bolender at the end of January and after flight data was presented at the February 6 meeting of the OMSF Management Council.) Although the decision was not irreversible, being subject to further investigations by both contractor and customer, both sides now were geared for a manned flight on the next LM mission. However, Evans cited several spacecraft functions not covered during the LM-1 flight that would have to be demonstrated before attempting a lunar mission, notably control by the primary navigation and guidance system of the

descent propulsion system burn as well as control of stage separation and firing of the ascent propulsion system. To demonstrate these functions fully, he said, some modifications in mission plans for the next two manned flights might be necessary.

Ltr., Evans to Low, Feb. 8, 1968.

1968
February

James P. Nolan, Jr., Chief of Plans, NASA OMSF, wrote Mission Operations Director John D. Stevenson describing a potential post-reentry fire hazard in the command module. A hazard might result from incomplete mixing of pure oxygen in the cockpit with normal air after landing, which could produce pockets of almost pure oxygen in closed cabinets, equipment bays, wire bundles, and interstices of the spacecraft. (Two test chamber explosions and fires had occurred at Douglas Aircraft Co. under similar conditions during the early 1950s, he advised.) Nolan suggested that the potential fire hazard be critically reviewed, including possible additional chamber flammability testing. Several weeks later, Stevenson informed Apollo Program Director Samuel C. Phillips that he had discussed Nolan's ideas with MSC Director Robert R. Gilruth, ensuring attention by the Flammability Review Board. He reported that MSC was planning an additional series of chamber tests to determine whether such a fire hazard actually existed.

14

Memos, Nolan to Director, Mission Operations, NASA, "Post Reentry Fire Hazard in the Command Module," Feb. 14, 1968; Stevenson to Apollo Program Director, same subject, Feb. 26, 1968.

In discussing the results of a manned test with MSC Director Robert R. Gilruth, George M. Low mentioned that a single 45-degree motion of the abort handle was required to initiate a launch abort in Apollo. Gilruth voiced concern that an abort could be caused by a single motion. Low asked Donald K. Slayton for comments on the subject. Slayton replied March 1 that "this item had also been a concern of the flight crews during the early design of the system." But he said: "The handle forces to actuate the abort sequence have been subjectively evaluated and are considered high enough to prevent inadvertent actuation. Additionally, the outboard rotation (counter clockwise) was chosen over an inboard rotation (clockwise) as being the more unnatural of the two motions. . . . Crew training for launch aborts in the Dynamic Crew Procedures Simulator has not shown this design to be a problem."

14

Memos, Low to Slayton, "Apollo Command Module abort handle," Feb. 14, 1968; Slayton to Manager, ASPO, "Apollo Command Module abort handle," Mar. 1, 1968.

NASA Hq. asked MSC's support for the effort under way by the Software Review Board (created at Apollo Program Director Samuel C. Phillips' request several weeks earlier) to reexamine software requirements for the lunar mission. A specific concern of the Board (which included representatives from the major support contractors, IBM, TRW, and Bellcomm) was

14

1968
February

the level of sophistication and complexity inherent in the present MIT computer programs. To understand better the possibilities of carrying out the lunar mission using the present computer system but with much simpler programming, Mueller asked the Board to examine the feasibility, cost, and schedule implications of carrying out the mission using about half the fixed and erasable memory of the computer and otherwise trading off program simplicity for minor increases in propellant requirements.

Ltr., George E. Mueller, NASA OMSF, to Robert R. Gilruth, MSC, Feb. 14, 1968.

15

Apollo Program Director Samuel C. Phillips wrote ASPO Manager George M. Low setting forth a strategy for announcing selection of a prelaunch atmosphere for the spacecraft. Because the decision undoubtedly would draw much public attention, Phillips said, it was important that the decision be based on comprehensive study and be fully documented to explain the rationale for the decision both to NASA's management and to the general public. Foremost, he said, that rationale must include a clear statement of physiological requirements for the mission and for aborts. Secondly, it must also cover flammability factors in cabin atmosphere selection. Finally, the decision rationale must explain engineering factors related to hardware capability and crew procedures, as well as operational factors and how they affected the choice of atmosphere during prelaunch and launch phases of the mission.

Ltr., Phillips to Low, "Pre-launch Atmosphere," Feb. 15, 1968.

19

Meetings of the Software Task Force had brought out the lack of a formal requirement that the Change Control Board (CCB) consider how hardware and software changes might affect each other, NASA Associate Administrator for Manned Flight Mueller told Apollo Director Phillips. Mueller asked Phillips if he would consider a program directive requiring such assessments before changes could be approved. On March 2, ASPO Manager George Low wrote a note to Flight Operations Director Chris Kraft concerning the same problem. Low believed "our CCB Manual required that any changes requiring or affecting more than one panel (e.g., your software panel and Kleinknecht's CSM panel) should come to the Apollo spacecraft CCB." Kraft replied April 12 that he concurred. Kraft said that "various MSC organizations are represented on my Software Control Board [SCB]. These representatives identify related impacts on other functional elements of the program during the discussion of change actions in the . . . meeting. Also, we have taken action to assure integrated assessment of software and spacecraft changes prior to presentation to the SCB. . . . T. F. Gibson, Jr., Flight Operations Directorate, and J. F. Goree, Jr., ASPO, have resolved working arrangements to assure . . . the disciplines called for by the Configuration Management Manual are carried out. I understand that the Change Integration Group in ASPO will critique proposed change actions to either software or spacecraft hardware and identify associated impacts. . . . Changes involving interfaces between the software and

spacecraft hardware, or other functional elements of the program, would then be brought to your CCB for disposition of the . . . change as prescribed by the Configuration Control Manual. . . . I feel . . . this formal change integration function is appropriate as a check and balance. . . .”

Memo, George E. Mueller to Samuel C. Phillips, “Software Task Force Meetings,” Feb. 19, 1968; informal note, Low to Kraft, Mar. 2, 1968; memo, Kraft to Low, “Software and spacecraft change integration,” Apr. 12, 1968.

1968
February

MSC Deputy Director George S. Trimble, Jr., recommended to Apollo Program Director Phillips that OMSF issue a definition for the end of the Apollo program. Trimble pointed out that parts of MSC planning would be clearer if there were a specified set of conditions which, when satisfied, would mark the termination of the Apollo program and the start of the lunar exploration program. He said: “It is recommended that the accomplishment of the first lunar landing and safe return of the crew be defined as the end of the Apollo Program. This will give a crisp ending that everyone can understand and will be the minimum cost program. The Lunar Exploration Program, or whatever name is selected, will have a definable whole and can be planned and defended as a unit. . . . The successful termination of the Apollo Program should not be dependent on the successful deployment of ALSEP, EVA on the lunar surface, photos, soil samples or other experiments. Such objectives should not be mandatory for the first landing mission.” Trimble added that he had discussed these points with NASA’s Associate Administrator for Manned Space Flight George E. Mueller and it was his understanding that Mueller not only agreed but also planned to include similar material in his congressional testimony in defense of the budget.

19

Ltr., Trimble to Phillips, Feb. 19, 1968.

ASPO Manager George Low appointed Douglas R. Broome to head a special task team to resolve the problem of water requirements aboard the Apollo spacecraft. For some six months, Low noted, numerous discussions had surrounded the question of water purity requirements and loading procedures. Several meetings and reviews, including one at MSC on January 16 and another at KSC on February 13, had failed to resolve the problem, and Low thus instructed Broome’s team to reach a “final and definite agreement” on acceptable water specifications and loading procedures. Much unnecessary time and effort had been expended on this problem, Low said, and he expected the team “to put this problem to rest once and for all.”

19

Memo, Low to distr., “Apollo water requirements,” Feb. 19, 1968.

Reflecting the climate of scientific thinking at his Center, MSC Director Robert R. Gilruth responded to inquiries from Homer E. Newell, NASA Associate Administrator, concerning vocal communications during exploration of the lunar surface. While he termed continuous talking undesirable, Gilruth stated an astronaut’s running comment would in effect

20

1968
February

form a set of field notes that a geologist might ordinarily keep during a field exercise. This normal vocal narrative, he told Newell, would keep ground control informed of mission progress and would ensure a maximum scientific return from the flight.

Ltr., Gilruth to Newell, Feb. 20, 1968; memo, Wilmot N. Hess, MSC Director of Science and Applications, to Special Assistant to the Director, "Astronaut activity on lunar surface," Feb. 19, 1968.

20

MSC informed NASA Hq. that a reaction control system (RCS) engine ruptured at Marquardt Corp. the previous night during a heater integration test within a normal duty cycle run. This was a development test; the cause of the rupture was unknown at the time of the report. A second RCS failure occurred at Marquardt March 6 during a rerun of the LM heater integration tests. The rerun series started March 2. No facility damage or personnel injuries were reported from either incident. Investigation was under way at Marquardt by both NASA and Marquardt engineers to determine the cause of the failures and the effect on the program.

TWXs, George M. Low, MSC, to NASA Hq., Attn: Director, Apollo Program Office, Feb. 20, 1968, and Mar. 6, 1968.

26

The LM Descent Engine Program Review was held at TRW Systems, Redondo Beach, Calif., reviewing the overall program status, technical and manufacturing problems, and program costs. Program status reports showed that 28 engines had been delivered in the LM descent engine program to date, including all White Sands Test Facility engines and engine rebuilds and all qualification test and flight engines; 9 WSTF engines and 12 flight engines remained to be delivered. Grumman indicated all engine delivery dates coincided with the vehicle need dates.

Ltr., C. H. Bolender, MSC, to NASA Hq., Attn: Edgar M. Cortright, "LM Descent Engine Program Review at TRW Systems on February 26, 1968," Mar. 11, 1968.

26

Stress corrosion and window problems in the LM had been resolved, NASA Associate Administrator for Manned Space Flight George E. Mueller advised the Administrator in his weekly progress report. By a thorough analysis of the entire structure of the spacecraft, a team of engineers at Grumman had determined that widespread stress corrosion on the vehicle was highly unlikely. Also, inspection of more than 1400 individual parts on exposed surfaces of lunar module test article LTA-3 and LMs 3 through 8 had failed to discover a single instance of stress corrosion cracking, and thus no major changes would be made to the structure of the spacecraft.

Regarding the window problem (a window had blown out during a routine pressure test of LM-5 on December 17, 1967), Mueller stated that the windows on the LM were made from the strongest glass ever used on manned spacecraft. The most important factor, he said, was to avoid scratches on the window surface. Accordingly, Grumman and MSC had instituted a new acceptance test procedure to be conducted at Bethpage

1968
February

immediately before installation, after which the windows would remain fully protected. The LM-5 window failure had been caused by a defect in the body of the glass. Grumman subsequently planned to pressure-test all LM windows at 17.2 newtons per square centimeter (25 pounds per square inch). Normal operating pressure was 4.0 newtons per sq cm (5.8 psia).

Memo, Mueller to NASA Administrator and Deputy Administrator, "Manned Space Flight Report—February 26, 1968."

The Flight Readiness Review Board for CSM 020, lunar module test article 2R (LTA-2R), and spacecraft-LM adapter 9 (SLA-9) met at KSC. Concern was expressed over the loss of parts and materials in the CSM. North American Rockwell reported that a search had been made for 38 man-hours and was terminated when it was felt that damage might result. A data-storage equipment item had failed at the vendor and was later installed on spacecraft 020. The "belt was off its associated pulley" and because of this and other open failures the equipment was replaced. The chairman noted that there was no reason why a device with belts could not be made without belt failure.

27

"Minutes of Meeting, The Flight Readiness Review Board, CSM 020/LTA-2R/SLA-9, February 27, 1968," submitted by H. L. Brendle, Secretary, approved by Robert R. Gilruth, MSC Director.

MSC Director of Flight Crew Operations Donald K. Slayton wrote Wilmot N. Hess, Director of Science and Applications, regarding priorities between scientific objectives and mission operations in Apollo mission planning, specifically for activities on the lunar surface. Slayton acknowledged that scientific priorities had to be included within an overall mission plan. However, those priorities must inevitably be adjusted by operational factors such as difficulty and duration of activities to maximize success of the mission. Flight planning for surface operations on the first Apollo landing mission, Slayton said, had followed guidelines laid down by ASPO Manager George M. Low on September 18, 1967 (reflecting an MSC Directors' consensus as voiced at a September 15 briefing on lunar surface activities):

28

- The first extravehicular activity excursion was to consist of a number of simple, mutually independent activities.
- A small lunar sample would be collected on the first excursion.
- The Apollo Lunar Surface Experiments Package (ALSEP) would not be deployed on the first excursion.
- For planning purposes, a second excursion was also included, with ALSEP deployment as the primary scientific objective.

Deployment of the ALSEP during the first EVA operation, he continued, appeared precluded by safety considerations (no objective ranked higher than the astronauts' initial familiarization with $\frac{1}{6}$ gravity). Should $\frac{1}{6}$ -gravity operations turn out to be simpler and less time-consuming than

1968
February

anticipated, ALSEP unloading might be possible; but Slayton stated that EVA experience during the Gemini program dictated a much more conservative plan.

Memo, Slayton to Hess, "Apollo lunar surface operations planning," Feb. 28, 1968.

29

In response to action required by the CSM 2TV-2 and CSM 101 Wire Board in October 1967, Dale D. Myers, CSM Program Manager at North American Rockwell, submitted to MSC results of a wire improvement study for the umbilical feedthrough area for the lower equipment bay. Myers stated that substantial improvements in wiring appearance in the lower equipment bay had been made even before the Wire Board's ordered study and that further improvements of any significant nature could not be made without major structural changes (which would be intolerable from the standpoint of mission schedules). Thus, Myers recommended against further changes in wiring in the lower equipment bay. Further, as installation procedures and wire protective measures had improved, the occurrence of wiring damage had been progressively reduced. This same rationale, Myers affirmed, applied to other harness areas inside the spacecraft. (This study by North American completed action items generated at the Wire Board meeting.)

Ltr., Myers to MSC CSM Manager Kenneth S. Kleinknecht, Feb. 29, 1968, with encl., "Summary Report on Block II Command Module Wiring Improvement Study."

March

1

MSC had decided not to static-fire the service modules of Block II spacecraft before flight (specifically, spacecraft 101), ASPO advised NASA Hq. The decision was based on successful completion of the spacecraft 102 static firing, evaluation of the test history on the service propulsion system, and a review by a joint MSC-MSFC team that came out flatly against any such static firings at KSC and acceded to such tests at White Sands only under Houston's strict authority. During subsequent discussions in Houston (notably a February 19 meeting with the MSFC contingent), program planners rejected such firings at White Sands because the additional transportation and handling might degrade reliability of the hardware—exactly the opposite of what was being sought.

Ltr., ASPO Manager George M. Low to Apollo Program Director Samuel C. Phillips, March 1, 1968.

1

John D. Stevenson, Director of Mission Operations, NASA OMSF, requested that MSC Flight Operations Director Christopher C. Kraft, Jr., prepare an analysis of the potential terrestrial threat posed by an uncontrolled reentry of the Apollo 6 spacecraft. (Surviving debris presented a possible danger should a service propulsion system failure or other malfunction preclude a controlled reentry.) Stevenson asked Kraft to include the debris hazard in MSC's Abort and Alternate Mission Study for Apollo 6 then under preparation.

Ltr., Stevenson to MSC, Attn: Kraft, "Terrestrial Threat from Apollo 6 CSM Control Failure," March 1, 1968.

The MSC Flammability Review Board met to assess results of the CSM flammability tests conducted on boilerplate 1224. The Board unanimously recommended using a 60-percent-oxygen and 40-percent-nitrogen atmosphere in the spacecraft cabin during launch, but continued use of a pure oxygen atmosphere at pressure of 4.1 newtons per square centimeter (6 pounds per square inch) during flight. Members concluded that this mixed-gas environment offered the best protection for the crew on the pad and during launch operations, while still meeting physiological and operational requirements. During the final stages of the flammability test program, tests had indicated that combustion characteristics for the 11-newtons-per-sq-cm (16-psi), 60-40 atmosphere and for the 4.1-newton pure oxygen atmosphere were remarkably similar. Also, full-scale trials had demonstrated that in an emergency the crew could get out of the spacecraft quickly and safely.

1968

March

4

Memo, George E. Mueller to Administrator, "Manned Space Flight Weekly Report—March 11, 1968."

Design Certification Reviews of CSM 101 and LM-3 were held at MSC. Significant program-level agreements reached included validation of a 60-percent-oxygen and 40-percent-nitrogen cabin atmosphere during launch (see March 4); reaffirmation of the February 6 Management Council decision that a second unmanned LM flight was not required; and the conclusion that, in light of successful static firing of the 102 service propulsion system and subsequent analysis, a static-firing of the 101 system was not required.

6-7

Ibid.

Apollo Special Task Team Director Eberhard F. M. Rees wrote Dale D. Myers, Apollo CSM Program Manager at North American Rockwell, to convey the concern of ASPO Manager George M. Low and others over the status of the S-band high-gain-antenna system. (Of all the subsystems in the spacecraft, that antenna seemed to face perhaps the toughest technical and schedule problems.) On December 14, 1967, Rees had visited the subcontractor's plant (Dalmo Victor) at Belmont, Calif., and had heard optimistic status reports on the entire system, including quality control and delivery schedules. Shortly thereafter, when Dalmo Victor began quality testing, the company encountered serious technical difficulties and the delivery schedule, as Rees put it, "collapsed completely." He then recounted several efforts by analytical teams to pinpoint the technical problems and to put the program back into shape (including reviews in mid-February and again on March 1, when very little progress could be seen). This record of inability to remedy technical problems, said Rees, indicated a serious weakness among Apollo contractors regarding visibility of their programs as well as their analytical engineering capability.

8

Ltr., Rees to Myers, March 8, 1968.

- 1968**
March
8 NASA technicians at KSC completed the flight readiness test for Apollo 6. The two-day event was delayed several days because of difficulties in modifying the service propulsion system tank skirt. With that significant launch-preparation event completed, program officials were reassessing the launch date in light of work remaining on the vehicle.
- Memo, George E. Mueller to Administrator, "Manned Space Flight Weekly Report—March 11, 1968."
- 11** North American Rockwell technicians at Downey completed integrated system testing on 2TV-1, the CSM thermal vacuum test vehicle. Shipment of the test article to MSC was scheduled for the end of March.
- Memo, George E. Mueller to Administrator, "Manned Space Flight Weekly Report—March 15, 1968," March 18, 1968.
- 12** Edgar M. Cortright, NASA Deputy Associate Administrator for Manned Space Flight, reported on the results of a thorough review of Apollo subcontractors made during January and February at the request of George E. Mueller. Cortright's review, coordinated with Apollo Program Directors in Washington and Houston, included detailed analysis of subsystem programs and on-site assessment of technical problems, schedule patterns, and testing programs. While favorably impressed with what he had found in general, he cited a number of what he termed "disturbing" conditions: most subsystems were facing hardware delivery schedule problems; many open failures existed; most qualification tests obviously would run beyond flight hardware delivery dates, requiring change-outs at KSC; several of the major subcontractors' difficulties had been compounded by lack of visibility of the overall spacecraft program (those "subs," he said, could have benefited from more attention by the "primes" and from allowing them a role in decision-making affecting their subsystems). Also, Cortright concluded that NASA itself could make more efficient use of subsystem managers and get them more deeply involved in the life of their respective programs. As a remedy to improve the total subsystem picture, Cortright recommended additional subsystem testing (and closer scrutiny by NASA of those tests); a reexamination of the entire Apollo system to determine any procedural errors in operating the subsystems that could result in failure of a subsystem; more contractor involvement in decision-making by both NASA and the primes; and greater emphasis on the manned space flight awareness program.
- Memo for record, Cortright, "Apollo subcontractor review," March 12, 1968.
- 14** NASA announced to the public that program officials had decided to use a 60-percent-oxygen and 40-percent-nitrogen atmosphere in the Apollo spacecraft cabin while on the launch pad (and to retain the pure-oxygen environment in space). This technical decision—because of the earlier tragedy with Apollo 204 over a year earlier—was subjected to closer public scrutiny than perhaps any comparable decision in the history of the U.S. space program. The change affected only ground operations and support

equipment and did not necessitate any major changes in the spacecraft itself. Exhaustive testing of the redesigned interior of the vehicle since October 1967 had demonstrated that the risk of fire inside the spacecraft had been drastically reduced. Hardware changes inside the cabin, spokesmen said, had minimized possible sources of ignition and materials changes had vastly reduced the danger of fire propagation.

1968

March

NASA News Release 68-47, "Apollo Spacecraft Cabin Atmosphere," March 14, 1968.

The MSC Structures and Mechanics Division reported to ASPO Manager George M. Low that additional verification of the spacecraft 020 reaction control system (RCS) pressure vessels would not be required. Using pressure vessel histories received March 14 and the previous propellant temperature restriction of 297 kelvins (75°F) maximum, fracture mechanics analyses showed: (1) all RCS helium tanks were satisfactory to maximum design operating pressure (MDOP); (2) all CM RCS propellant tanks were satisfactory to MDOP; (3) all SM RCS tanks were satisfactory to MDOP; and (4) the differences between measured MDOPs on RCS SM oxidizer tanks and the pressures assured safe by fracture mechanics were considered to be insignificant differences.

18

Memo, Joseph N. Kotanchik to ASPO Manager, "Fracture Mechanics Review of Spacecraft 020 Reaction Control System (RCS) Pressure Vessels," March 18, 1968.

Samuel C. Phillips, NASA Apollo Program Director, expressed concern to ASPO Manager George Low that relaxed review procedures on LM-4 and LM-5 might tend to delay identification and resolution of problems. Phillips had understood that the LM-4 Phase II Customer Acceptance Readiness Review (CARR) had been rescheduled and that the LM-5 Phase I and Phase II CARRs might be combined. He requested that every possible effort be made to get a good Phase II review on LM-4 and separate Phase I and Phase II reviews on LM-5.

18

Ltr., Phillips to Low, March 18, 1968.

ASPO Manager George Low emphatically rejected North American Rockwell's suggestion of added spacecraft delivery delays. Responding to a February letter from North American CSM Program Manager Dale D. Myers—suggesting further slips in delivery of 2TV-1 and spacecraft 101, 103, and 104—Low reminded Myers that at the close of the Configuration Control Board meeting on February 23 he had cited a mid-April target for delivery of CSM 101. Since that time, Low said, KSC had been actively preparing for an early summer launch based on that mid-April delivery, and circumstances therefore made that date most important. Moreover, North American must deliver CSM 103 by the end of June 1968 in order to ensure meeting Apollo's end-of-the-decade goal. He reminded Myers that he had pursued this point on several occasions with him and with William Bergen. They both had told Low that they had found ways to deliver 103 within that time frame, and Low now suggested that this target date be made a firm

19

1968

March

commitment in the official Apollo schedules. At the earliest possible date, Low concluded, MSC and North American must establish firm contractual baselines for delivery schedules. Until then present delivery dates remained valid. He admitted that some schedule slips had resulted from NASA-dictated changes and that the schedules should be adjusted accordingly. The remaining delays, however, Low attributed directly to the company's inability to meet projected commitments. The contract was changed to call for an April 1968 delivery for CSM 101 and a June 1968 delivery for CSM 103.

Ltr., Low to Myers, March 19, 1968; Part IV Contract NAS9-150.

21

The lunar landing research vehicle was operating and training was being conducted, MSC Director Robert R. Gilruth wrote Langley Research Center's Acting Director Charles J. Donlan. MSC intended to conduct a second class for LLRV pilots and one of the first requirements for checkout was a familiarization program on Langley's Lunar Landing Research Facility. He requested that a program be conducted for not less than four nor more than six MSC pilots between April 15 and May 15.

Ltr., Gilruth to Donlan, March 21, 1968.

21

MSC asked Grumman to make a thorough review of the amount of nominal, off-nominal, and extended-life subsystem testing of LM production hardware and recommend any additional testing that should be done. The review of performance data was needed, Neal said, to ensure that program officials had sufficient test data to support flight planners and flight controllers during the manned missions.

Ltr., James L. Neal, LM Contracting Officer, MSC, to Joseph G. Gavin, LM Program Manager, Grumman Aircraft Engineering Corp., "Contract NAS 9-1100, Proposal for additional subsystem testing," March 21, 1968.

21

In an effort to resolve the continuing technical and schedule problems with the high-gain antenna system at Dalmo Victor, Apollo CSM Program Manager Dale D. Myers named a Resident Subsystem Project Manager at the vendor's plant. This change provided a single management interface with Dalmo Victor. The representative had been given authority to call on whatever North American Rockwell resources he might need to accomplish program objectives.

Ltr., Myers to Kenneth S. Kleinknecht, MSC, March 21, 1968.

22

Eberhard F. M. Rees, Director of the Apollo Special Task Team at North American Rockwell, wrote to the company's CSM Program Manager Dale D. Myers to express his concern over persistent problems with leaks in the ball valves for the service propulsion system. Rees doubted that any real progress was being made, stating that the problem persisted despite relaxations in leakage criteria and that qualification failures continued to occur. Rees described a review of the program on March 18 at Aerojet-General Corp. as lacking in factual depth. Also, the company did not appear

to be pursuing developmental testing of configurational changes with any degree of vigor. Rees suggested to Myers that his people were on the right track and with management attention the vendor's efforts could be channeled to get some genuine results.

1968

March

Ltr., Rees to Myers, March 22, 1968, with encl., "Minutes of AGC Ball Valve Presentation," March 18, 1968.

Apollo drogue chute test 99-5 failed at the El Centro, Calif., parachute facility. The drop was conducted to demonstrate the slight change made in the reefed area and the 10-second reefing cutter at ultimate load conditions. The 5897-kilogram vehicle was launched from a B-52 aircraft at 10 668 meters and programmer chute operation and timing appeared normal. At drogue deployment following mortar activation, one drogue appeared to separate from the vehicle. This chute was not recovered but ground observers indicated the failure seemed to occur in the riser or vehicle attachment. The second drogue remained on the vehicle but seemed to slip in the reefed state. This chute was recovered and inspection confirmed the canopy failure. The Air Force parachute system which was to recover the vehicle also failed in the reefed state.

23

TWX, George M. Low, MSC, to NASA Hq., Attn: Director, Apollo Program Office, March 23, 1968.

ASPO documented its reasons for using nitrogen rather than helium (as the Air Force had done) as the diluent in the Apollo spacecraft's cabin atmosphere, in response to a suggestion from Julian M. West of NASA Hq. Aaron Cohen, Assistant Chief of the MSC Systems Engineering Division, recounted that the Atmosphere Selection Task Team had addressed the question of nitrogen versus helium (regardless of percentage) and had rejected helium because of uncertainty of the compatibility of spacecraft equipment with helium. Further, helium presented the same physiological problems as did nitrogen, and whatever flammabilities advantages helium possessed were extremely small. For all these reasons, Cohen explained, the team had early elected to concentrate on nitrogen-mixed atmospheres.

27

Memo, George M. Low, MSC, to West, "Selection of nitrogen as a diluent for the Apollo launch atmosphere," March 27, 1968, with encl., memo, Cohen to Low, "Nitrogen selection as a diluent," March 25, 1968.

A LM prelaunch atmosphere selection and repressurization meeting was held at MSC, attended by representatives of MSC, MSFC, KSC, North American Rockwell, and Grumman. The rationale for MSC selection of 100 percent oxygen as the LM cabin launch atmosphere was based on three factors: use of other than 100 percent oxygen in the LM cabin would entail additional crew procedural workloads at transposition and docking; excessive risk to crew due to depletion of the CM emergency oxygen consumables would be added; and it would require use of 2.7 kilograms of onboard CM oxygen. Two problems were identified with use of 100 percent oxygen in the LM cabin at launch: LM cabin flammability on the pad and

27-28

1968

March

LM venting oxygen into the SLA during boost. If air were used in the LM cabin at launch and the LM vent valve opened during boost, the full CM stored-oxygen capacity would be required to pressurize the LM and LM tunnel for umbilical mating. For a lunar mission, this situation would be similar to that before lunar orbital insertion, but would subject the crew to a condition of no stored oxygen for an emergency. For an earth-orbital mission this situation would be objectionable because CM stored oxygen would be lacking for an emergency entry into the atmosphere. (See also April 22 entry.)

Ltr., Low to addressees, April 17, 1968, with encl., memo, Assistant Chief, Systems Engineering Div. to addressees, "Minutes of LM Repressurization Meeting," April 8, 1968.

29

Scott H. Simpkinson, Acting Chief of ASPO Test Division, authorized assignment of Boeing-TIE personnel to Downey, Calif., and Bethpage, N.Y., to support test evaluation areas—because of fixed limitations on the number of resident NASA personnel at the prime contractors' locations.

Memos, Simpkinson to Chief, Program Control, "Boeing-TIE support," March 29, 1968.

29

Samuel C. Phillips, NASA Apollo Program Director, wrote ASPO Manager George M. Low to express concern about two particular technical problems in the Apollo Lunar Surface Experiments Package: (1) a system for on-the-pad coding of the SNAP-27 radioactive fuel cask and (2) the overall weight status of the ALSEP (especially the recent decision to charge the weight penalty of the remote deployment mechanism to the ALSEP weight budget itself). Because ALSEP was the key to success of the Apollo science program, Phillips asked that Low take the lead in reviewing these and any other pertinent technical problems to effect early resolution and ensure success of the program.

Ltr., Phillips to Low, March 29, 1968.

29

NASA Hq. asked that MSC consider a variety of lunar photographic operations from orbit during manned landing missions. Cancellation from Apollo of the lunar mapping and survey system had eliminated any specially designed lunar photographic capability; but photography was still desired for scientific, operational, and contingency purposes. Presence of the CSM in orbit during manned landing missions, Headquarters OMSF said, would be a valuable opportunity, however limited, for photographic operations. MSC was asked to evaluate these operations to define whatever hardware and operational changes in Apollo might be required to capitalize upon this opportunity.

Ltr., Samuel C. Phillips, Apollo Program Director, NASA Hq., to Director Robert R. Gilruth, MSC, "Lunar Photography from the CSM," March 29, 1968.

April

2

NASA Hq. confirmed oral instructions to MSC and KSC to use 60 percent oxygen and 40 percent nitrogen to pressurize the Apollo CM cabin in prelaunch checkout operations and during manned chamber testing, as rec-

ommended by the Design Certification Review Board on March 7 and confirmed by the NASA Administrator on March 12. This instruction was applicable to flight and test articles at all locations.

1968

April

TWX, Samuel C. Phillips to MSC, Attn: G. M. Low and KSC, Attn: R. O. Middleton, April 2, 1968.

Eberhard F. M. Rees, Director of the Special Task Team at North American Rockwell, spearheaded a design review of the CM water sterilization system at Downey, Calif. (The review had resulted as an action item from the March 21 Configuration Control Board meeting in Downey.) Rees and a team of North American engineers reviewed the design of the system and test results and problems to date. Chief among performance concerns seemed to be compatibility of the chlorine solution with several materials in the system, maximum allowable concentration of chlorine in the water supply from the medical aspect, and contamination of the system during storage, handling, and filling. Assuming North American's successful completion of qualification testing and attention to the foregoing action items, said Rees, the system design was judged satisfactory.

2

Ltr., Dale D. Myers to George M. Low, April 8, 1968, with encl., "CSM Water Sterilization System CDR, April 2, 1968."

Apollo 6 (AS-502) was launched from Complex 39A at Kennedy Space Center. The space vehicle consisted of a Saturn V launch vehicle with an unmanned, modified Block I command and service module (CSM 020) and a lunar module test article (LTA-2R).

4

Liftoff at 7:00 a.m. EST was normal but, during the first-stage (S-IC) boost phase, oscillations and abrupt measurement changes were observed. During the second-stage (S-II) boost phase, two of the J-2 engines shut down early and the remaining three were extended approximately one minute to compensate. The third-stage (S-IVB) firing was also longer than planned and at termination of thrust the orbit was 177.7 x 362.9 kilometers rather than the 160.9-kilometer near-circular orbit planned. The attempt to reignite the S-IVB engine for the translunar injection was unsuccessful. Reentry speed was 10 kilometers per second rather than the planned 11.1, and the spacecraft landed 90.7 kilometers uprange of the targeted landing point.

The most significant spacecraft anomaly occurred at about 2 minutes 13 seconds after liftoff, when abrupt changes were indicated by strain, vibration, and acceleration measurements in the S-IVB, instrument unit, adapter, lunar module test article, and CSM. Apparently oscillations induced by the launch vehicle exceeded the spacecraft design criteria.

The second-stage (S-II) burn was normal until about 4 minutes 38 seconds after liftoff; then difficulties were recorded. Engine 2 cutoff was recorded

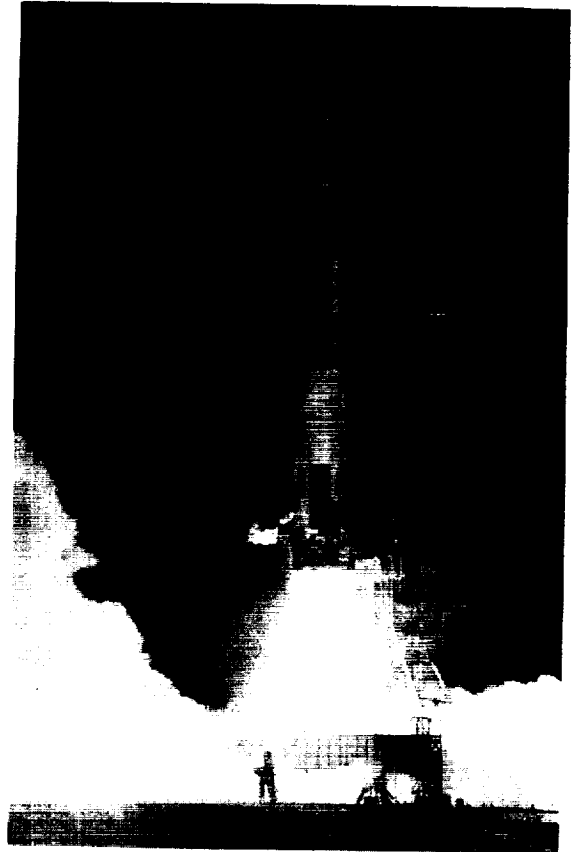

Saturn V launches *Apollo 6* on April 4, 1968, carrying a LM test article and an unmanned Apollo Block I CM, modified to include the unified hatch flown for the first time as a complete unit.

1968

April

about 6 minutes 53 seconds into the flight and engine 3 cutoff less than 3 seconds later. The remaining second-stage engines shut down at 9 minutes 36 seconds—58 seconds later than planned.

The S-IVB engine during its first burn, which was normal, operated 29 seconds longer than programmed. After two revolutions in a parking orbit, during which the systems were checked, operational tests performed, and several attitude maneuvers made, preparations were completed for the S-IVB engine restart. The firing was scheduled to occur on the Cape Kennedy pass at the end of the second revolution, but could not be accomplished. A ground command was sent to the CSM to carry out a planned alternate mission, and the CSM separated from the S-IVB stage.

A service propulsion system (SPS) engine firing sequence resulted in a 442-second burn and an accompanying free-return orbit of 22 259.1 x 33.3 kilometers. Since the SPS was used to attain the desired high apogee, there was insufficient propellant left to gain the high-velocity increase desired for the entry. For this reason, a complete firing sequence was performed except that the thrust was inhibited.

Parachute deployment was normal and the spacecraft landed about 9 hours 50 minutes after liftoff, in the mid-Pacific, 90.7 kilometers uprange from the predicted landing area. A normal retrieval was made by the U.S.S. *Okinawa*, with waves of 2.1 to 2.4 meters.

1968

April

The spacecraft was in good condition, including the unified crew hatch, flown for the first time. Charring of the thermal protection was about the same as that experienced on the *Apollo 4* spacecraft (CM 017).

Of the five primary objectives, three—demonstrating separation of launch vehicle stages, performance of the emergency detection system (EDS) in a close-loop mode, and mission support facilities and operations—were achieved. Only partially achieved were the objectives of confirming structure and thermal integrity, compatibility of launch vehicle and spacecraft, and launch loads and dynamic characteristics; and of verifying operation of launch vehicle propulsion, guidance and control, and electrical systems. *Apollo 6*, therefore, was officially judged in December as “not a success in accordance with . . . NASA mission objectives.”

Memos, Chief, Landing and Recovery Div. to Director of Flight Operations, MSC, “Apollo 6 preliminary recovery information,” April 5, 1968; Apollo Program Director Samuel C. Phillips to Administrator, NASA, “Apollo 6 Mission (AS-502) Post Launch Report #1,” April 18, 1968, with attachment, “Post Launch Mission Operation Report No. M-932-68-06”; Phillips to Acting Administrator, “Apollo 6 Mission (AS-502) Post Launch Report #2,” Dec 27, 1968; “Apollo 6 Mission Report,” prepared by Apollo 6 Mission Evaluation Team, approved by George M. Low, June 1968.

Howard W. Tindall, Jr., Chief of Apollo Data Priority Coordination, reported that several meetings devoted to the question of the LM’s status immediately after touching down on the lunar surface, had reached agreement on several operational techniques for a “go/no go” decision. Basically, the period immediately after landing constituted a system evaluation phase (in which both crew and ground controllers assessed the spacecraft’s status)—a period of about two minutes, during which immediate abort and ascent was possible. Given a decision at that point not to abort, the crew would then remove the guidance system from the descent mode and proceed with the normal ascent-powered flight program (and an immediate abort was no longer possible). Assuming permission to stay beyond this initial “make ready” phase, the crew would then carry out most of the normal procedures required to launch when the CM next passed over the landing site (some two hours later).

Memo, Tindall to distr., “Mission techniques for the LM lunar stay go/no go,” April 4, 1968.

Astronauts James A. Lovell, Jr., Stuart A. Roosa, and Charles M. Duke, Jr., participated in a recovery test of spacecraft 007, conducted by the MSC Landing and Recovery Division in the Gulf of Mexico. The test crew reported that while they did not “recommend the Apollo spacecraft for any extended sea voyages they encountered no serious habitability problems during the 48-hour test. If a comparison can be made, the interior configurations and seaworthiness make the Apollo spacecraft a much better vessel than the Gemini spacecraft.” The following conclusions were reached: (1) The Apollo spacecraft, as represented by spacecraft 007 and under ambient conditions tested, was suitable for a 48-hour delayed recovery. (2) The interference between the survival radio beacon and VHF

1968

April

communications was unsatisfactory. Spacecraft to aircraft communication ranges seemed unusually low. (3) There was no requirement for the sea-water hand pump.

Memo, Donald K. Slayton to Director of Flight Operations, "Crew report on 48-hour recovery test of spacecraft 007 on April 5-7, 1968," April 12, 1968

10

The Apollo spacecraft Configuration Control Board (CCB) had endorsed changes in lunar orbit insertion and LM extraction on the lunar mission flight profile, the MSC Director notified the Apollo Program Director. ASPO had reviewed the changes with William Schneider of NASA OMSF the same day and Schneider was to present the changes to George E. Mueller and Samuel C. Phillips for approval.

The two-burn lunar orbit insertion (LOI) was an operational procedure to desensitize the maneuver to system uncertainties and would allow for optimization of a lunar orbit trim burn. The procedure would be used for lunar orbit and lunar landing missions. The spacecraft lunar-adapter spring-ejection system was required to ensure adequate clearance during separation of the LM/CSM from the S-IVB/instrument unit and would be used on the first manned CSM/LM mission.

Ltr., Robert R. Gilruth to Phillips, "Proposed changes to Lunar Orbit Insertion and LM extraction on the Lunar Mission Flight Profile," April 10, 1968.

10

A TV camera would be carried in CM 101 on the first manned Apollo flight, Apollo Program Director Samuel C. Phillips, wrote the ASPO Manager (confirming their discussions). Incorporation and use of the camera in CM 101 would conform to the following ground rules: (1) The TV camera and associated hardware would be installed at KSC with no impact on launch schedule; (2) the camera would be stowed during the launch phase; (3) a mounting bracket for the camera would be provided in the CM to permit simultaneous viewing of all three couch assemblies, for use in monitoring prelaunch hazardous tests and in flight; (4) the camera could be hand-held for viewing outside the CM during flight; and (5) use of the camera would not be specified on the astronaut's flight planning timeline of essential activities but would be incorporated in the mission as time and opportunity would permit.

Ltr., Director, Apollo Program, NASA OMSF, to Manager ASPO, "Apollo On-Board TV," April 10, 1968.

12

A number of decisions were made at the completion of a parachute review at Northrop-Ventura: (1) The spacecraft 101 parachute system would be flown without further changes. (2) A higher drogue-mortar-muzzle velocity would be planned, with a possible effectivity for spacecraft 103. North American Rockwell would determine what ground tests were required, when flight hardware would be ready, and what additional qualification tests were needed. (3) Proposed Northrop-Ventura changes in drogue riser size and riser length would be considered only for design and ground testing

activities. (4) North American would propose to NASA an augmented confidence-level test program. (5) For follow-on work, NASA would contract directly with Northrop-Ventura only for analytical work (all test effort would be contracted through North American). (6) Northrop-Ventura would examine the swagged fittings to determine whether a possible stress corrosion problem might exist. (7) Northrop-Ventura would obtain sufficient documentary photography during parachute packing for manned flight vehicles to provide subsequent quality examination. (8) Northrop-Ventura would prepare a package depicting the flight and design envelope of the parachutes, together with tests already achieved and tests planned. (9) Firm direction to Northrop-Ventura in all applicable areas would be provided by North American.

1968

April

Memo, George M. Low to Kenneth S. Kleinknecht, "Action items from the Northrop Ventura meeting," April 15, 1968.

Apollo Special Task Team Director Eberhard Rees wrote Dale D. Myers at North American Rockwell: "As you are well aware, many manhours have been spent investigating and discussing the radially cracked insulation on wire supplied by Haveg Industries. On March 27, 1968, NR [North American Rockwell] made a presentation on this problem and reported the action taken to correct the problem and to prevent defective wire from being used. . . . It was disturbing to me to learn that with all the additional actions . . . cracked insulation again was found, this time during the manufacture of harnesses for C/M 110, 111, 112 and S/M 111. This raises the question as to whether the total problem has really been identified and whether or not sufficient corrective action has been taken. . . ." Rees then requested a reply to 10 questions he submitted as to reasons for the problem and possible actions that might be taken.

12

Ltr., Rees to Myers, April 12, 1968.

A meeting at MSC with Irving Pinkel of Lewis Research Center and Robert Van Dolah of the Bureau of Mines reviewed results of boilerplate 1224 tests at 11.4 newtons per square centimeter (16.5 pounds per square inch) in a 60-percent-oxygen and 40-percent-nitrogen atmosphere. (Both Pinkel and Van Dolah had been members of the Apollo 204 Review Board. Others attending were Jerry Craig, Richard Johnston, and George Abbey, all of MSC; and George Gill and Fred Yeamans, both of GE.) The total boilerplate 1224 test program was reviewed as well as test results at 11 newtons per sq cm (16 psi) in 60 percent oxygen and 40 percent nitrogen and also in 95 percent oxygen. Both Pinkel and Van Dolah agreed with the MSC position that the tests proved the spacecraft was qualified for testing and flight in the 60-40 environment. They expressed the opinion that the 60-40 atmosphere seemed a reasonable compromise between flammability, physiological, and operational considerations.

16

Memo, Chief, Thermodynamics and Materials Br., to Chief, Systems Engineering Div., "Review of BP 1224 test data with I. Pinkel and R. Van Dolah," April 19, 1968.

1968
April
17 MSC Engineering and Development Director Maxime Faget reported to George Low that his directorate had investigated numerous radiation detectors, ionization particle detectors, and chemical reactive detectors. The directorate had also obtained information from outside sources such as the National Bureau of Standards, Mine Safety Appliances, Parmalee Plastics, Wright-Patterson Air Force Base, and the Air Force Manned Orbiting Laboratory organization. None of the methods investigated could meet the stated requirements for a spacecraft fire detection system.

Memo, Faget to Low, "Status of development effort for fire detection system," April 17, 1968.

17 MSC Director Robert R. Gilruth recommended to NASA Associate Administrator for Manned Space Flight George E. Mueller that MSC's Sigurd A. Sjoberg be approved as the U.S. Representative to the International Committee for Aeronautics of the Fédération Aéronautique Internationale. Robert Dillaway of North American Rockwell, who had been serving as U.S. Representative, had accepted a position with the Navy and recommended Sjoberg to James F. Nields, President of the National Aeronautic Association, and to Major General Brooke F. Allen, Executive Director of the Association, and they had concurred in the recommendation. NASA Hq. approved the request May 20.

Ltrs., Gilruth to Mueller, April 17, 1968; Mueller to Gilruth, May 20, 1968.

18 Two major requirements existed for further service propulsion system (SPS) testing at the Arnold Engineering Development Center (AEDC), ASPO Manager George M. Low advised Apollo Program Director Samuel C. Phillips. First, the LM docking structure was marginal at peak SPS start transient. While evaluation of the redesigned docking mechanism was under way, final hardware design and production could not be completed until positive identification of the start transient was made through the AEDC test series. Secondly, a modified engine valve had been incorporated into the SPS for CSM 101, which thus necessitated further certification testing before flight (comprising sea-level static firings, simulated altitude firings, and component endurance tests). Low emphasized the need to complete this testing as soon as possible, to isolate any potential problems.

Ltr., Low to Phillips, April 18, 1968.

22 ASPO Manager George M. Low advised top officials in Headquarters, MSFC, and KSC that he was recommending the use of 100 percent oxygen in the cabin of the LM at launch. MSC had reached this decision, Low said, after thorough evaluation of system capabilities, requirements, safety, and crew procedures. The selection of pure oxygen was based on several important factors: reduced demand on the CSM's oxygen supply by some 2.7 kilograms; simplified crew procedures; the capability for immediate return to earth during earth-orbital missions in which docking was performed; and safe physiological characteristics. All of these factors, the ASPO Chief stated, outweighed the flammability question. Because the LM was

unmanned on the pad, there was little electrical power in the vehicle at launch and therefore few ignition sources. Further, the adapter was filled with inert nitrogen and the danger of a hazardous condition was therefore minimal. Also, temperature and pressure sensors inside the LM could be used for fire detection, and fire could be fought while the mobile service structure was in place. As a result, Low stated, use of oxygen in the LM on the pad posed no more of a hazard than did hypergolics and liquid hydrogen and oxygen.

Ltr., Low to Samuel C. Phillips, R. O. Middleton, KSC, and Arthur Rudolph, MSFC, April 22, 1968.

MSC Director Robert R. Gilruth observed that the Engineering and Development Directorate would be conducting two thermal-vacuum test programs during the next several months, following the April 9 shipment of the Block II thermal vacuum test article 2TV-1 to MSC from Downey. (The second test article was the LM counterpart, LTA-8.) Both programs were of major importance, Gilruth told his organization. However, because the 2TV-1 test program directly supported—and constrained—the first manned Apollo mission, he said that, in the event of any conflict between the two test programs, 2TV-1 had clear priority.

Memo, Gilruth to distr., "Program Priority," April 22, 1968.

1968

April

22

CSM 2TV-1 (thermal vacuum test vehicle No. 1) in integrated checkout testing at Manned Spacecraft Center in 1968. The vehicle was manufactured and ready for test later than planned, placing a constraint on the Apollo program.

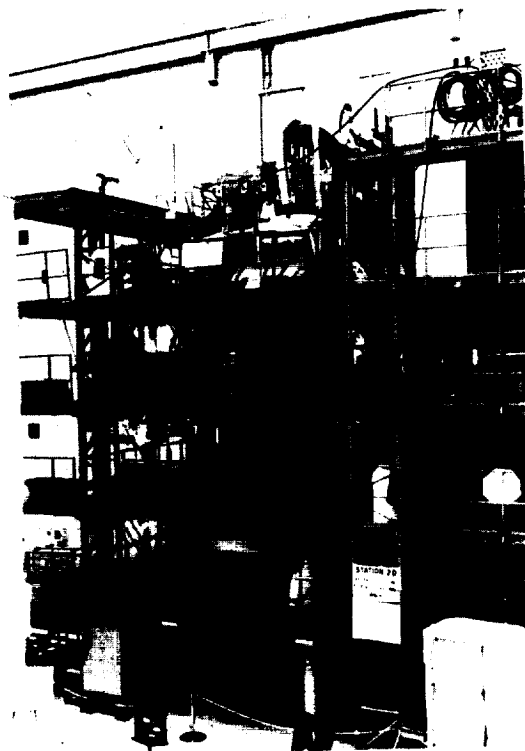

1968
April
23

ASPO Manager George M. Low requested Joseph N. Kotanchik to establish a task team to pull together all participants in the dynamic analysis of the Saturn V and boost environment. He suggested that Donald C. Wade should lead the effort and that he should work with George Jeffs of North American Rockwell, Tom Kelly of Grumman and Wayne Klopfenstein of Boeing, and that Lee James of MSFC could be contacted for any desired support or coordination. The team would define the allowable oscillations at the interface of the spacecraft-LM adapter with the instrument unit for the existing Block II configuration, possible changes in the hardware to detune the CSM and the LM, and the combined effects of pogo and the S-IC single-engine-out case. Low also said he was establishing a task team under Richard Colonna to define a test program related to the same problem area and felt that Wade and Colonna would want to work together.

Memo, Low to J. N. Kotanchik through M. A. Faget, "CSM/LM/SLA dynamic analysis," April 23, 1968.

27

NASA Administrator James E. Webb approved plans to proceed with preparation of the third Saturn V space vehicle for a manned mission in the fourth quarter of 1968. The planned mission was to follow the unmanned November 9, 1967, *Apollo 4* and April 4, 1968, *Apollo 6* flights, launched on the first two Saturn V vehicles. NASA kept the option of flying another unmanned mission if further analysis and testing indicated that was the best course. Engineers had been working around the clock to determine causes of and solutions to problems met on the *Apollo 6* flight.

NASA News Release 68-81, "Manned Apollo Flight," April 29, 1968.

27

ASPO Manager George M. Low explained to the Apollo Program Director the underlying causes of slips in CSM and LM delivery dates since establishment of contract dates during the fall of 1967. The general excuse, Low said, was that slips were the result of NASA-directed hardware changes. "This excuse is not valid." He recounted how NASA-imposed changes had been under strict control and only essential changes had been approved by the MSC Level II Configuration Control Board (CCB). For early spacecraft (CSM 101 and 103 and LM-3), the CCB had agreed some six months earlier that only flight safety changes would be approved. To achieve firm understandings with the two prime spacecraft contractors regarding the responsibilities for schedule slips, Low had asked MSC procurement expert Dave W. Lang to negotiate new contract delivery dates based on changes since the last round of negotiations. These negotiations with North American Rockwell were now completed. (Talks at Grumman had not yet started.) Despite a leniency in the negotiations on early spacecraft, Low said, results clearly indicated that most schedule delays were attributable to North American and not to NASA. On 2TV-1, for example, delivered two months late, analysis proved that less than three weeks of this delay derived from customer-dictated changes. The situation for CSM 101, though not yet delivered, was comparable. Moreover, a similar situation existed within the

LM program: LM-3 would be delivered some five weeks behind the contract date, with only two of those weeks caused by NASA changes. Despite this attempt to set the record straight regarding schedule slippages, Low stressed that he did not wish to be over critical of the contractors' performance. Because schedules over the past year had been based on three-shift, seven-day-per-week operation, little or no time existed for troubleshooting and "make work" changes that inevitably cropped up during checkout activities.

1968

April

Ltr., Low to Samuel C. Phillips, NASA Hq., April 27, 1968.

ASPO was implementing actions recommended by Edgar M. Cortright following his review of Apollo subsystem programs and visits to Apollo subcontractors (see March 12), ASPO Manager George Low advised Apollo Program Director Sam Phillips. These additional steps included further testing of hardware (including "augmented" testing to define nominal and off-nominal operating conditions better); better NASA overseeing of certification test requirements and results; a reexamination by the Crew Safety Review Board of system operating procedures, with emphasis on crew operations; closer subcontractor participation in program decisionmaking, chiefly through the proposed augmented tests and product improvement program; and greater emphasis at the subcontractor plants on the manned flight awareness program.

30

Ltr., Low to Phillips, "Apollo Subcontractor Review," April 30, 1968.

ASPO Manager George M. Low ordered LM Manager C. H. Bolender to establish a firm baseline configuration for the LM ascent engine to use during the entire series of qualification tests (including any penalty runs that might be required). Low's memo followed a telephone conversation the previous day with Apollo Program Director Samuel C. Phillips. Low cited to Bolender the need for a rigid design control on the engine. During a recent technical review, he explained, NASA officials learned that most qualification tests had been performed on one model (the E2CA injector), while all of the bomb stability tests had used another (the E2C injector). Ostensibly, the only difference between the two injectors was in the welding techniques. However, the first E2CA injector that was bomb-tested showed a combustion instability. Low emphasized that he was not charging that the different welding technique had caused the instability. Nevertheless, "this supposedly minor change [has] again served to emphasize the importance of making no changes, no matter how small, in the configuration of this engine." Once Bolender had set up the requested baseline configuration, Low stated, no change either in design or process should be made without approval by the Configuration Control Board.

May

1

Phillips followed up his conversation with Low a week later to express a deep concern regarding the ascent engine program, particularly small improvements in the engine, which could very likely delay the entire Apollo program beyond the present goal. The sensitivity of the engine to even

1968

May

minor design, fabrication, and testing changes dictated absolute control over all such changes. The ascent engine, Phillips told Low, was one of a very few Apollo hardware items in which even the most insignificant change must be elevated to top-level management review before implementation.

Memo, Low to Bolender, "Design freeze of ascent engine," May 1, 1968; ltr., Phillips to Low, May 6, 1968.

6

Lunar landing research vehicle (LLRV) No. 1 crashed at Ellington Air Force Base, Tex. The pilot, astronaut Neil A. Armstrong, ejected after losing control of the vehicle, landing by parachute with minor injury. Estimated altitude of the LLRV at the time of ejection was 60 meters. LLRV No. 1, which had been on a standard training mission, was a total loss—estimated at \$1.5 million. LLRV No. 2 would not begin flight status until the accident investigation had been completed and the cause determined. (The LLTV's had not completed their ground test phase and were not included in this category.) MSC Director Robert R. Gilruth appointed a Board of Investigation, composed of: Joseph S. Algranti, Chief, Aircraft Operations Office, MSC; William A. Anders, Astronaut Office, qualified pilot; Charles Conrad, qualified pilot (temporary member, to be replaced by Donald L. Mallick); Donald L. Mallick, Chief, Research Pilots Branch, Flight Research Center; George L. Bosworth, Aircraft Maintenance—Quality Assurance Branch, Maintenance Officer; and C. H. Roberts, Aircraft Operations Office, Acting Flying Safety Officer. (See also May 16 and October 17.)

TWX, Richard H. Holzapfel, MSC, to NASA, Attn: B. P. Helgeson, May 7, 1968.

13

During an Apollo flight test program review at MSC, the question was left unresolved whether or not to perform a "fire-in-the-hole" test of the LM ascent engine (i.e., start the engine at the same instant the two stages of the spacecraft were disjoined—as the engine would have to be fired upon takeoff from the lunar surface) on either the D or E mission. At the review, several participants had suggested that the test be performed on the D mission because that would be the last Apollo flight containing development flight instrumentation (DFI). Later that day, ASPO Manager George M. Low met with several of the Center's Associate Directors (Christopher C. Kraft, Jr., Donald K. Slayton, and Maxime A. Faget) to pursue the issue further. At that time, Faget stated that, although desirable, DFI was not essential for the test objective. Most important, he said, was obtaining photographs of the base of the ascent engine following the burn. In view of Faget's contention—and because the fire-in-the-hole test added greatly to the complexity and risk of the D mission at the time the engine was first fired in space, Low and the others agreed not to include such an ascent engine burn in the flight. Low asked Faget to analyze ascent engine test experience and results of the LM-1 ascent engine burn before making any decision on such a test during the E mission.

Memo, Low to Faget, "Fire-in-the-Hole Test," May 13, 1968.

Robert R. Gilruth, MSC Director, announced reassignment of three officials. John D. Hodge was assigned as Director of the newly established Lunar Exploration Working Group. Aleck C. Bond, Manager of the Reliability and Quality Assurance Office and the Flight Safety Office, would be reassigned effective June 1 as Manager, Systems Test and Evaluation, Engineering and Development Directorate. Martin L. Raines, Manager, White Sands Test Facility, would become acting manager of the Reliability and Quality Assurance Office and the Flight Safety Office, in addition to his White Sands assignment.

1968

May

14

MSC News Release 68-35, May 14, 1968.

NASA Headquarters established the LLRV-1 Review Board to investigate the May 6 accidental crash of Lunar Landing Research Vehicle No. 1 at Ellington Air Force Base. The Board would consist of: Bruce T. Lundin, Lewis Research Center, chairman; John Stevenson, OMSF; Miles Ross, KSC; James Whitten, Langley Research Center; and Lt. Col. Jephtha D. Oliver (USAF), Norton Air Force Base. J. Wallace Ould, MSC Chief Counsel, would serve as counsel to the group. The board would (1) determine the probable cause or causes of the accident, (2) identify and evaluate proposed corrective actions, (3) evaluate the implications of the accident for LLRV and LM design and operations, (4) report its findings to the NASA Administrator as expeditiously as possible but no later than July 15, and (5) document its findings and submit a final report to the Administrator with a copy to the NASA Safety Director. (See October 17.)

16

Memo, Thomas O. Paine to LLRV-1 Review Board, "Investigation and Review of Crash of Lunar Landing Research Vehicle #1," May 16, 1968.

Christopher C. Kraft, Jr., MSC Director of Flight Operations, expressed concern to ASPO Manager George M. Low over the escalation of E-mission objectives; the flight now loomed as an extremely complex and ambitious mission. The probability of accomplishing all the objectives set forth for the mission, said Kraft, was very low. He did not propose changing the mission plan, however. "If we are fortunate," he said, "then certainly the quickest way to the moon will be achieved." Kraft did suggest caution in setting mission priorities and in "apply[ing] adjectives to the objectives." Specifically, he advised a realistic allowance of delta V limits at various points in the rendezvous portion of the mission, to ensure safe termination of the exercise if required. Also, he saw little value in a fire-in-the-hole burn of the ascent engine at stage separation of the LM. He believed that ground tests were adequate to provide answers on pressure and temperature rises on the ascent stage during launch from the lunar surface. The situation Kraft said was indicative of the engineer's desire to test fully all systems in flight in both normal and backup modes. However, reliance must be placed largely on the wealth of ground testing and analysis carried on to date in the Apollo program.

17

Memo, Kraft to Manager, Apollo Program, "Apollo Flight Test Program," May 17, 1968.

1968

May

21

Following up on an earlier request to examine the potential for lunar photography of the moon from the CSM during Apollo lunar missions (see March 29), Apollo Program Director Samuel C. Phillips asked MSC Director Robert R. Gilruth to expand MSC's effort to include the potential for a range of scientific investigations. Specifically, he asked that MSC study the overall potential of the CSM for lunar science and the modification needed to support increasingly complex experiment payloads. Among experiments that might be carried out from the CSM Phillips cited infrared spectrometer radiometer, ultraviolet absorption spectrometer, passive microwave, radar-laser altimetry, and subsatellites.

Ltr., Phillips to Gilruth, "Lunar Scientific Experiments from the CSM," May 21, 1968.

22

Twist-and-solder wire splices were evaluated for ASPO Manager Low by Systems Engineering Division. The evaluation stated that twist-and-solder wire splices with shrink sleeve tubing had been used for many years and when properly done were adequate. It then listed three advantages and six disadvantages of this kind of splice. In summary, it stated that the splice could be phased into the LM program but was not recommended by the division because: (1) there are too many variables; (2) the present solder splice (either heat or ZAP gun) had none of the disadvantages or variables mentioned; (3) a substantial amount of time would be required to establish and implement qualification; and (4) qualification testing had proven the present solder splices adequate. LM Program Manager C. H. Bolender had the memo hand-carried to George Low's office, since he was temporarily withholding approval of an engineering change proposal for Grumman to implement use of the ZAP gun for solder splices. Low, in turn, sent an "Urgent Action" note to his Assistant Manager for Flight Safety, Scott H. Simpkinson, asking his views on the problem and saying, in part, "Personally, I would only use the twist-and-solder splice—but I may be old fashioned." Simpkinson replied to Low with an informal note on May 23, agreeing with the recommendations of the Systems Engineering Division. Simpkinson said, ". . . The worst wire splice in the *production* world is the twist-and-solder, and cover with tubing. . . . I believe we should use the present LM splice method which has been qualified." He recommended the ZAP gun, "which controls the heat properly so that all the advantages of the present LM wire splices can be realized," recalling the phrase, 'Let's not improve ourselves into a new set of problems.'" On that same day Low instructed Bolender to proceed with the ZAP gun Grumman splices.

Memo, Owen E. Maynard, Chief, Systems Engineering Div., ASPO, to Manager, ASPO, "Evaluation of the twist-and-solder wire splice," May 22, 1968; note, Lyle D. White, Systems Engineering Div., to Low, May 22, 1968; Urgent Action note, Low to Simpkinson, undated; note, Simpkinson to Low, May 23, 1968; note, Low to Bolender, May 23, 1968.

24

Apollo Program Director Samuel C. Phillips requested from MSC Director Robert R. Gilruth a recommended program for spacesuit modifications to achieve greater astronaut maneuverability. The modifications were required for lunar landing missions, because extravehicular activities such as

sampling and instrument deployment were difficult and time consuming with the present suit configuration. Phillips asked for trade-off studies to achieve optimized life support systems, an analysis of mobility requirements and techniques to enhance mobility, and studies of crew station requirements and problem areas such as suit repair, storage, and checkout.

1968

May

Ltr., Phillips to Gilruth "Improvement of Apollo Spacesuit for Lunar Surface EVA Tasks,"
May 24, 1968.

ASPO Manager George M. Low informed Apollo Program Director Samuel C. Phillips of recent MSC work on the effects of launch vehicle-induced oscillations—i.e., "pogo" vibrations—on the spacecraft and its subsystems. MSC had made two key personnel assignments in this area: (1) Rolf W. Lanzkron managed all MSC activities in connection with the space vehicle dynamic integrity problem; and (2) astronaut Charles M. Duke coordinated all MSC's efforts with related work at MSFC. Low also cited a number of decisions in the hardware and testing areas. He had decided to use CM 002B, SM 105, and LM-2 for pogo dynamics testing. Other ground test hardware included LTA-3 for manned drop tests and for additional structural verification tests, CM 102 to verify parachute-imposed loads on the spacecraft structure, and CMs 014 and 102 for additional structural tests at North American Rockwell. In deciding upon uses for these and other spacecraft hardware items, MSC had assigned first priority to the ground test program, second to another potential unmanned Saturn V flight, and third to the dual launch capability.

25

Ltr., Low to Phillips, May 25, 1968.

NASA and Grumman officials met to resolve the issue of the injector for the LM ascent engine. Chief NASA Apollo spacecraft program officials present included Director Samuel C. Phillips and MSC's ASPO Manager George M. Low and LM Manager C. H. Bolender; Grumman LM directors and engineers included LM Program Director Joseph G. Gavin. Several alternatives seemed feasible: continue the program with the existing Bell Aerosystems Co. engine and injector; furnish Bell Aerosystems Co. engines to Rocketdyne to be mated to the Rocketdyne injector; or ship Rocketdyne injectors to Bell for installation in the engine. After what Low termed "considerable discussion," he dictated the course to be followed:

28

- The LM ascent engine would comprise Bell's engine with the Rocketdyne injector. Rocketdyne would be responsible for delivery of the complete engine, and would thus become a subcontractor to Grumman. (Bell could either remain as subcontractor to Grumman or become a subcontractor to Rocketdyne.)

- An engine with the Rocketdyne injector would be immediately installed in LM-3, as well as in LM-4 and LM-5, with minimum schedule impact.

- Grumman was to proceed forthwith on contract negotiations with Bell and Rocketdyne to cover these procurements.

1968

May

- Rocketdyne was to continue qualification on the present injector design, and engine firings at White Sands Test Facility in support of LM-3 were to use the Rocketdyne injector.

Grumman participants at this meeting, as Low almost casually phrased it, "indicated that they would interpose no objections to this set of decisions." After long months of technical effort and almost agonizing hardware and managerial debate, the issue of an ascent engine for the LM was settled.

Memo for Record, Low, "Ascent engine injector," May 31, 1968.

29

NASA's North American Management Performance Award Board sent a summary of its findings for the first interim period, from September 1967 through March 1968, to North American Rockwell's Space Division. The review board had been charged with assessing the company's performance under spacecraft contract NAS 9-150 and determining an award fee under the contract's incentive agreements. Board Chairman B. L. Dorman wrote Space Division President William B. Bergen that the Board had been impressed by the attention of North American's top management to the CSM program. Moreover, a cooperative attitude from top to bottom had afforded NASA an excellent view into problem areas, while the company's assessment of problems had helped to produce high-quality hardware. On the other hand, several activities needed improvement: cost control; tighter management control over change traffic; stronger management of subcontractors; and better planning and implementation of test and checkout functions.

Ltr., Dorman to Bergen, May 29, 1968.

During
the
Month

NASA Associate Administrator for Manned Space Flight George E. Mueller recommended to the Administrator several alternative uses for the LM-2 vehicle, since that spacecraft was no longer destined for flight. (The successful LM-1 flight during the *Apollo 5* mission in January had obviated the need for a second such unmanned flight.) Mueller suggested that LM-2 be used for nondestructive tests and for documentary photography. Additional drop tests with the craft, he said, would enhance confidence in the strength of the LM to withstand the impact of landing on the moon, with all subsystems functioning. (The LM drop test program using Lunar Test Article 3, Mueller said, would verify the LM structure itself; however, LTA-3 contained no operational subsystems, wiring, or plumbing and therefore could not verify the total flight vehicle.) Among several other possible uses for the vehicle examined but rejected, Mueller cited modifying the craft into a manned configuration for Apollo or using it for an early Apollo Applications flight. LM-2 was unsuitable for both these alternatives, he stated, because of the extensive structural modifications needed to make it a flightworthy Apollo spacecraft—and the attendant disruption of vehicle flow within the Grumman production line—and because of the many fire-proofing changes that would be required. The launch vehicle

(SA-206), LM adapter, and protective shroud were to be placed in storage for further Saturn tests if needed.

1968

May

Memo, Mueller to NASA Administrator, "Disposition and Usage of AS-206/LM-2 Hardware," n.d.

ASPO Manager George Low advised Apollo program officials at KSC that, to collect adequate data for evaluating any potential toxicological hazard inside the spacecraft, collection of gas samples of the cabin atmosphere must be made for 12 hours during the unmanned altitude chamber test with all systems operating. Low asked that this requirement be included in the spacecraft test procedures. (Purpose of a total CSM 101 and LM-3 toxicological evaluation was to verify that no toxic contaminants were given off by the nonmetallic materials used in the crew compartments.)

June

3

Ltr., Low to R. O. Middleton, KSC, "Toxicological evaluation of CSM 101 and LM-3," June 3, 1968.

Apollo Program Director Sam Phillips asked ASPO Manager George Low to investigate the value of using freon as a fire extinguishing agent inside the spacecraft. Admittedly, Phillips said, MSC had considered using a freon extinguisher system shortly after the AS-204 accident, but it had been rejected, largely because of toxicity factors and because tests had shown the agent ineffective in extinguishing combustion of polyurethane in a pure oxygen atmosphere. A number of factors now dictated a reevaluation of such an extinguisher system, however:

3

- Additional testing of late had indicated a lower toxicity problem than earlier believed.
- The addition of oxygen masks to the spacecraft now afforded some protection against a toxic atmosphere.
- Because of post-accident changes inside the cabin, the flammability problem had been reduced to a few specific materials (quite different from polyurethane foam) sited in compartmentalized locations inside the cabin.
- The oxygen-nitrogen mixed gas had been selected as the prelaunch atmosphere inside the cabin.

In view of these changes, Phillips said, a freon extinguishing system might be better than the present jelled water extinguisher (quicker activation and reduced equipment damage). He asked that Low not overlook this potential improvement in crew safety, which could be of particular value during the high-risk period of launch, when the crew was essentially immobilized by the forces of acceleration.

Ltr., Phillips to Low, "CBrF₃ (Freon 1301) as a Fire Extinguishing Agent," June 3, 1968.

George E. Mueller, Associate Administrator for Manned Space Flight, wrote MSC Director Robert R. Gilruth to express his personal interest in lunar extravehicular activity (EVA) training for the Apollo crews of the F and G missions (i.e., the initial lunar landing and subsequent flights). Because of

5

1968

June

the complexity of the EVA tasks that the astronauts must perform, Mueller said, crews for those missions should be selected as early as possible. Also, realistic training—including a realistic run-through of many of the lunar surface tasks, especially development of the S-band antenna and the Apollo Lunar Surface Experiments Package and sampling operations—must be conducted to ensure that the crews competently carried out the various scientific experiments and other tasks during their brief stays on the moon.

Ltr., Mueller to Gilruth, June 5, 1968.

7

ASPO Manager George M. Low and others from MSC met with Grumman's LM engineering staff, headed by Thomas J. Kelly, to discuss the descent stage heatshield and thermal blanket problems associated with reduced thrust decay of the descent engine at lunar touchdown. Several significant decisions were reached:

- The touchdown probe was lengthened to 1.6 meters.
- Effective on LM-5 and later vehicles, Grumman would "beef up" (both structurally and thermally) the base heatshield.
- Grumman was to conduct a series of tests on overpressure of the descent engine.
- Grumman would begin design studies of a jettisonable descent engine skirt.
- Landing stability would be reexamined with the existing thrust tailoff profile (a study to be made either by Grumman or by Boeing; Low asked Maxime A. Faget, Director of Engineering and Development at MSC, to review this proposed test plan and to recommend where it should be conducted, for best cost, schedule, and technical capabilities).

Memo, Low to C. H. Bolender, "LM descent stage base heatshield," June 8, 1968.

10

In his weekly progress report to the NASA Administrator, Deputy Administrator for Manned Space Flight George E. Mueller cited several important Apollo events during the first week of June: (1) On June 1, technicians at MSC completed thermal-vacuum testing on LTA-8 to support LM-3, including 45½ hours of manned testing. All spacecraft systems functioned normally, and preliminary results indicated that all significant test objectives had been realized. (2) Engineers and technicians at KSC completed receiving inspection of CSM 101 on June 3. That inspection revealed fewer discrepancies than had been present on any other spacecraft delivered to the Cape. Pre-mate inspection of CM 101 also was completed, as were leakage and functional tests on the electrical power and reaction control systems. SM 101 was in the altitude chamber being prepared for combined systems testing.

Memo, Mueller to NASA Administrator, "Manned Space Flight Weekly Report—June 7, 1968," June 10, 1968.

1968

June

10

ASPO Manager George M. Low met with Christopher C. Kraft, Jr., and Donald K. Slayton, Directors of MSC Flight and Flight Crew Operations, and several members of their staffs (including astronaut Walter M. Schirra, Jr.) to discuss using the flight combustion stability monitor (FCSM) on the Apollo 7 flight. (The FCSM was a safety device to shut down the service propulsion system [SPS] automatically in the event of rough combustion or instability.) At the insistence of the Propulsion and Power Division, they agreed to use the FCSM for all SPS burns on Apollo 7. On all "noncritical" burns, two attempts to start the engine would be made with the FCSM active. Should the stability monitor shut down the engine on both those attempts, a detailed review of the situation would be made before again attempting to start the engine. On "critical" burns (i.e., the abort-to-orbit and reentry burns), should the FCSM halt the burn the SPS engine would be restarted immediately with the FCSM inactive on the assumption that the shutdown was caused either by an FCSM malfunction or by an engine instability that would not reoccur on the next start.

Low, Kraft, and the others unanimously wanted to eliminate the FCSM before a lunar mission, because on this mission lunar orbit and transearth insertion burns were highly critical and inadvertent shutdowns would cause major trajectory perturbations. Representatives from the Propulsion and Power Division (PPD) contended that, because of the relatively small number of bomb tests carried out on the Block II SPS engine, flight-testing of the engine before the lunar mission would be inadequate to demonstrate engine stability under all conditions. Low therefore asked Engineering and Development Director Maxime A. Faget and PPD Chief Joseph G. Thibodaux, Jr., to plan a ground test program that would give sufficient confidence in the SPS engine to eliminate the FCSM before undertaking lunar missions.

Ltr., Low to Thibodaux, "Use of FCSM on Apollo 7," June 11, 1968.

Dale D. Myers, Apollo CSM Program Manager at North American Rockwell, advised MSC officials of his company's investigation of two pilot-chute riser failures during recent drop tests of the Block II earth-landing system. Should there be any imperfections in either hardware or assembly techniques, Myers explained, the Block II pilot chute and riser system could be a marginal-strength item. Investigations had determined that early manufacturing processes had allowed a differential length between the two plies of nylon webbing in the pilot-chute riser which caused unequal load distribution between the two plies and low total riser strength. Because of the earlier test failures, Myers said, the pilot chute riser had been redesigned. The two-ply nylon webbing had been replaced by continuous suspension lines (i.e., 12 nylon cords) and the 5.5-millimeter-diameter cable was changed to 6.3-millimeter cable. He then cited a series of recent tests that verified the redesigned pilot-chute riser's strength to meet deployment under worst-case operational conditions.

11

Ltr., Myers to K. S. Kleinknecht, MSC, June 11, 1968.

1968

June

17

Apollo Program Director Phillips wrote MSC Director Gilruth concerning the April 10 proposal for a two-burn lunar orbit insertion (LOI) maneuver and a spring ejection of the LM from the spacecraft-lunar module adapter. Phillips agreed to the two-burn LOI in place of the originally planned one burn if results of an analysis should prove the requirement. He specified that an analysis be made of the tradeoffs and that the analysis include the risk of crash, the assumed risks due to lengthening the lunar orbit time (about four hours), and risks due to an additional spacecraft propulsion system burn, as well as the effect of the lunar gravitational potential on the ability to target the LOI maneuver to achieve the desired vector at the time of LM descent. The proposal for spring ejection of the LM from the SLA was approved with the provision that a failure analysis be made in order to understand the risks in the change.

Ltr., Samuel C. Phillips, OMSF, to Robert R. Gilruth, MSC, June 17, 1968.

July

3

NASA and contractor technicians successfully conducted the final parachute drop test to qualify the Apollo CSM earth-landing system. The Block II ELS thus was considered ready for manned flight after 12 Block I, 4 Block II, and 7 increased-capability Block II Qualification Tests—that had followed 77 Block I, 6 Block II, and 25 increased-capability Block II Development Drop Tests.

Memo, George E. Mueller, NASA OMSF, to NASA Administrator and Deputy Administrator, "Manned Space Flight Weekly Report—July 5, 1968," July 8, 1968; NASA Technical Note (NASA TN D-7437), "Apollo Experience Report—Earth Landing System."

5

ASPO Manager George M. Low asked Aaron Cohen, one of his chief technical assistants, to investigate the ability of the Apollo spacecraft to withstand bending loads imposed by a failure of one or more engines on the Saturn V launch vehicle (as well as actual loads that would be imposed on the spacecraft). During the previous week, Low and the Configuration Control Board had ruled out making any significant design changes to cope with a Saturn V engine failure. Specifically, Low asked how bending loads on the spacecraft were derived; what bending loads were imposed on the spacecraft during the *Apollo 6* mission, where two J-2 engines were cut off during the flight; what was the probability—and criticality—of an S-1C engine's failing and thereby imposing high bending loads; and whether abort limits should be established for an engine failure.

Memo, Low to Cohen, "Saturn V single engine out problems," July 5, 1968.

10-11

The Apollo Design Certification Review (DCR) Board met in Houston to examine CSM 101 and the Block II CSM for proof of design and development maturity and to certify the designs for flightworthiness and manned flight safety. (Three earlier reviews directly supported this penultimate scrutiny of the vehicle's development: the CSM 101 Design Certification Review March 6-7, the Block II environmental control system and spacesuit DCR May 8, and the DCR covering the CM land and water impact test

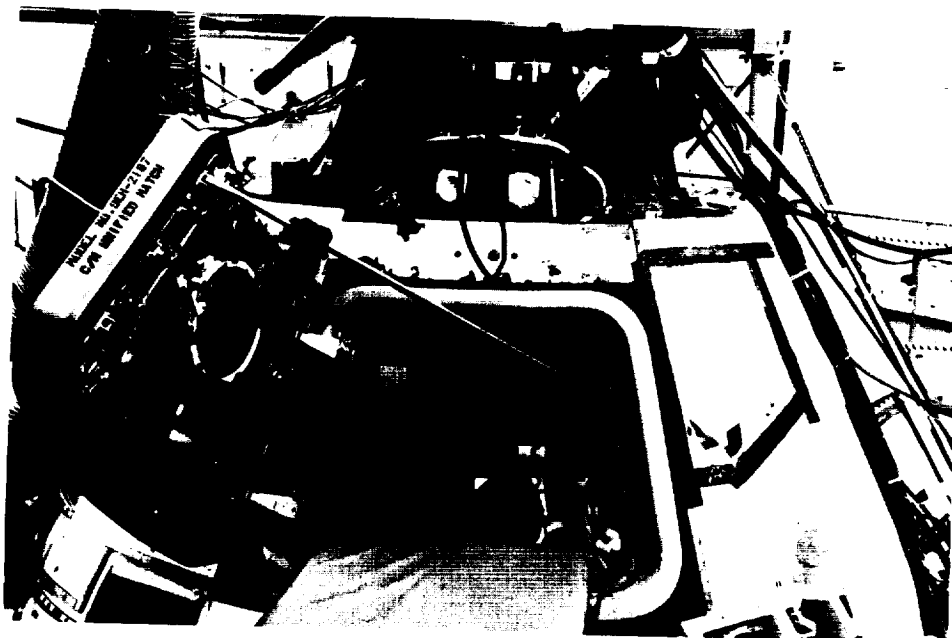

Command module 101

program June 6.) The board concluded that design certification on CSM 101 was complete. Action and open items were subsequently forwarded to the Centers for resolution, to be closed before the Apollo 7 Flight Readiness Review.

1968

July

Ltr., Samuel C. Phillips, NASA Hq., to distr., "CSM 101 and Block II CSM Delta Design Certification Review," Aug. 28, 1968.

ASPO Manager Low informed Apollo Program Director Phillips of several changes in the LM vibration testing program. Before beginning the series of tests, he told Phillips, red line values were established on critical components that were not to be exceeded. However, because of the most recent test effort on LM-2, which resulted from the pogo problem experienced during the flight of *Apollo 6*, Low was forced to authorize vibration testing beyond the red line values initially set for the spacecraft. This action, in turn, forced an inspection and possible refurbishment of LM-2 to make it available for an unmanned flight, should such a second unmanned LM test mission be required. He then cited MSC's future plans for LM-2:

11

- For the planned drop tests with the vehicle, the upper decks would be inspected and repaired or replaced where necessary.
- Should a LM-2 flight become necessary, all of the descent stage upper decks would probably be replaced.

- 1968**
July
- Phillips approved Low's action immediately. He urged Low to "continue to give priority to that work which is necessary for full and early resolution of the POGO and spacecraft structural dynamics questions."
- Ltr., George M. Low to Samuel C. Phillips, July 11, 1968, with handwritten notation by Phillips dated July 11, 1968.
- 13**
- ASPO Manager George M. Low wrote to Grumman President Llewellyn J. Evans to call his attention to the problem of continued propellant leaks in the LM. "In spite of all of our efforts, last summer" (i.e., with the extensive plumbing rework done on LM-1 after its delivery to Florida), Low said, technicians at KSC found a leak on one of the lines on LM-3, even though no leaks had been observed during checkout at Bethpage. Investigating the problem, Low had learned that Grumman had made some propellant-system design changes that had led to installation of four-bolt flanges with single teflon O-ring seals—despite the fact that during the preceding summer NASA and Grumman had jointly agreed not to use this joint on the LM vehicle. This most recent problem, said Low, again points up the importance of strictest control of all design changes in the spacecraft. Because of the need for maintaining a lunar-configured LM as a design baseline, all spacecraft design changes had to be carried through the Apollo Configuration Control Board before implementation.
- Ltr., Low to Evans, July 13, 1968.
- 15**
- NASA Apollo Program Director Samuel C. Phillips laid down Headquarters and MSC interfaces with the Atomic Energy Commission (AEC) regarding the SNAP-27 radioisotope thermoelectric generator for the Apollo Lunar Surface Experiments Package (ALSEP). The Lunar Surface Program Office at MSC was the field project office responsible for developing the ALSEP system, and the radioisotope generator—as part of the ALSEP—had been assigned to that office for system integration. Thus, the Lunar Surface Program Office served as the AEC's primary contact on the SNAP-27 both for ALSEP program matters and for data pertaining to flight safety and documentation for flight approval. Phillips stressed that all data be fully coordinated with Headquarters before being submitted to the AEC. (Approval for the flight of any nuclear device rested ultimately with the President, but formal documentation had to be concurred in by the NASA Administrator, the AEC Commissioners, the Secretary of Defense, and the National Aeronautics and Space Council.)
- Memo, Phillips to George M. Low, ASPO, MSC, "Atomic Energy Commission Interfaces," July 15, 1968.
- 17**
- NASA Associate Administrator George E. Mueller, Apollo Program Director Samuel C. Phillips, and other high-ranking manned space flight officials from Headquarters visited Bethpage for an overall review of the LM program. Greatest emphasis during their review was on schedules, technical problems, and qualification of the spacecraft's principal subsystems. Mueller and Phillips cited several areas that most concerned NASA:

- Delivery schedules from subcontractors and vendors had slipped significantly during the past year, to the point where many components were only marginally supporting spacecraft deliveries.
- The large number of hardware changes made during the past year was affecting costs and schedules.
- Costs forecast for Fiscal Year 1969 exceeded the current LM budget.

1968

July

Mueller also suggested that Grumman consider eliminating the LM rendezvous radar to save weight aboard the vehicle. He stated that VHF ranging would be more accurate and would probably be the preferred mode of operation.

Memo, C. H. Bolender, MSC LM Manager, to Manager, Apollo Spacecraft Program, MSC, "Dr. Mueller's visit to GAEC on July 17, 1968," July 19, 1968.

In the continuing effort to reduce costs while still maintaining a balanced and viable program, ASPO Manager George M. Low recommended to NASA Hq. that CSM 102 be deleted from the manned flight program. He estimated total savings at \$25.5 million (excluding cost of refurbishment after the current ground test program). In addition, he said, during the static structural test program at North American Rockwell, CSM 102 would be subjected to loads that would compromise structural integrity of the vehicle for manned flight.

22

Ltr., Low to Samuel C. Phillips, "Deletion of CSM 102 from the manned flight program," July 22, 1968.

Prompted by a request from MSC to increase the Saturn V's performance to 46 070 kilograms for lunar missions, Samuel C. Phillips sought to strike a balance between spacecraft and launch vehicle weight-performance demands. He established as a new payload interface definition at translunar injection a payload of 46 040 kilograms. Should the vehicle per se be incapable of achieving this figure, said Phillips, he would relax certain flight constraints to achieve the best possible balance between the space vehicle and the specific mission to be flown. But he implored both ASPO Manager George M. Low and Lee B. James, Saturn V Program Manager at MSFC, to work toward this balance between spacecraft and launch vehicle and to avoid any hardware changes in the Saturn V solely to meet the new payload interface weight.

23

Ltr., Phillips to James and Low, "Saturn V Payload Interface Definition," July 23, 1968.

F. A. Speer, Mission Operations Manager at MSFC, advised NASA Hq. of plans for S-IVB and spacecraft separation and employment of a "slingshot" trajectory following insertion into the trajectory toward the moon. Residuals in the S-IVB, said Speer, could be used to place the stage in a

30

1968

July

trajectory that would avoid recontact with the spacecraft and impact on either the earth or the moon—with preclusion of spacecraft–launch vehicle collision as the most important priority.

Ltr., Speer to William C. Schneider, Apollo Mission Director, NASA, "Lunar Debris," July 30, 1968.

August

1

Howard W. Tindall, Jr., Deputy Division Chief, MSC Mission Planning and Analysis, wrote ASPO Manager George M. Low: "A rather unbelievable proposal has been bouncing around lately. Because it is seriously ascribed to a high ranking official, MSC and Grumman are both on the verge of initiating activities—feasibility studies, procedures development, etc.—in accord with it. . . . The matter to which I refer is the possibility of deleting the rendezvous radar from the LM. The first thing that comes to mind, although not perhaps the most important, is that the uproar from the astronaut office will be fantastic—and I'll join in with my small voice too. Without rendezvous radar there is absolutely no observational data going into the LM to support rendezvous maneuvers. . . . Please see if you can stop this if it's real and save both MSC and GAEC a lot of trouble." On August 9 Low wrote NASA Apollo Program Manager Samuel Phillips that, shortly after Associate Administrator for Manned Space George Mueller had visited Grumman, Low had calls from both C. H. Bolender, MSC, and Joseph Gavin, Grumman, indicating that Mueller had made a suggestion "that we should eliminate the LM rendezvous radar as a weight saving device." He forwarded Tindall's memorandum as the basis for "why we should not consider deleting the radar and why we shouldn't spend any more effort on this work." Low added that MSC was discontinuing "any work that we may have started as a result of George's comments." In a reply on August 28, Phillips told Low, "I am in complete agreement . . . that all work toward deleting the LM rendezvous radar should be discouraged and I have written to George Mueller to that effect."

Memo, Tindall to Manager, ASPO, "LM rendezvous radar is essential," Aug. 1, 1968; ltrs., Low to Phillips, Aug. 9, 1968, Phillips to Low, Aug. 28, 1968.

2

In an effort to stem the number of hardware changes at KSC, Apollo Program Director Samuel C. Phillips instituted a weekly review of all changes that produced additional work at KSC in excess of normal checkout flow. Phillips stressed the extraordinary importance of change control and the requirement that only mandatory changes be approved through the control boards at MSC and MSFC. The volume of changes currently under way at KSC constituted a major concern. Key program objectives, he said, were in jeopardy.

TWXs, Phillips to distr., Aug. 2 and 19, 1968.

7

The Apollo Design Certification Review (DCR) Board convened at MSC to examine LM-3 further for proof of design and development maturity and to assess and certify the design of the LM-3 as flightworthy and safe for

manned flight. This Delta review was identified as a requirement at the March 6 LM-3 DCR. The Board concluded at the close of the Delta DCR that LM-3 was safe to fly manned with the completion of open work and action items identified during the review.

1968
August

Ltr., Apollo Program Director to distr., "LM-3 Delta Design Certification Review," Sept. 12, 1968.

ASPO Manager George M. Low and several members of his staff met at KSC with Center Director Kurt H. Debus, Launch Operations Director Rocco A. Petrone, and KSC Apollo Program Manager R. O. Middleton to discuss test and checkout problems for AS-503 and AS-504. They collectively agreed that only mandatory changes—i.e., changes for flight safety or to ensure mission success—could be made once the spacecraft reached KSC. (Changes that would speed the KSC checkout flow also were permitted.) Furthermore, two separate work packages would be prepared for each spacecraft customer acceptance readiness review board. The first package comprised normal work to be performed at KSC on all spacecraft. The second included special work normally done at the factory, but which for that specific vehicle was being transferred to the Cape (installation, retesting, etc.). The group also reviewed recent Apollo checkout experiences—especially test failures and open items—in an effort to improve these areas for subsequent missions.

8

Memo for record, Low, "Report of meeting at KSC," Aug. 10, 1968.

ASPO Manager George M. Low initiated a series of actions that led to the eventual decision that AS-503 (Apollo 8) should be a lunar orbital mission. Events and the situation during June and July had indicated to Low that the only way for the "in this decade" goal to be attained was to launch the Saturn 503/CSM 103/LM-3 mission in 1968. During June and July the projected launch slipped from November to December, with no assurance of a December launch. Later, Low recalled "the possibility of a circumlunar or lunar orbit mission during 1968, using AS-503 and CSM 103 first occurred to me as a contingency mission."

August 9–
November 12

During the period of July 20–August 5, pogo problems that had arisen on *Apollo 6* seemed headed toward resolution; work on the CSM slowed, but progress was satisfactory; delivery was scheduled at KSC during the second week in August and the spacecraft was exceptionally clean. The LM still required a lot of work and chances were slim for a 1968 launch.

On August 7, Low asked MSC's Director of Flight Operations Christopher C. Kraft, Jr., to look into the feasibility of a lunar orbit mission for Apollo 8 without carrying the LM. A mission with the LM looked as if it might slip until February or March 1969. The following day Low traveled to KSC for an AS-503 review, and from the work schedule it looked like a January 1969 launch.

August 9 was probably one of the busiest days in George Low's life; the activities of that and the following days enabled the United States to meet

1968**August**

the "in this decade" goal. At 8:45 a.m. he met with MSC Director Robert R. Gilruth and told him he had been considering a lunar orbit mission. Gilruth was highly enthusiastic. At 9:00 a.m. Low met with Kraft and was informed that the mission was technically feasible from ground control and spacecraft computer standpoint. (A decision had been made several months earlier to put a Colossus onboard computer program on the 103 spacecraft.)

At 9:30 a.m. Low met with Gilruth, Kraft, and Director of Flight Crew Operations Donald K. Slayton, and they unanimously decided to seek support from MSFC Director Wernher von Braun and Apollo Program Director Samuel C. Phillips. Gilruth called von Braun and, after briefly outlining the plan, asked if they could meet in Huntsville that afternoon. Low called Phillips, who was at KSC, and asked whether he and KSC Director Kurt Debus could participate and a meeting was set up for 2:30.

Present at the 2:30 p.m. meeting at MSFC were von Braun, Eberhard Rees, Lee James, and Ludie Richard, all of MSFC; Phillips and George Hage, both of OMSF; Debus and Rocco Petrone, MSFC; and Gilruth, Low, Kraft, and Slayton of MSC. Low outlined the hardware situation and told the group it was technically feasible to fly the lunar orbit mission in December 1968, with the qualification that Apollo 7 would have to be a very successful mission. If not successful, Apollo 8 would be another earth-orbital mission. Kraft made a strong point that to gain lunar landing benefits Apollo 8 would have to be a lunar orbital rather than a circumlunar mission. All were enthusiastic. Phillips began outlining necessary events: KSC said it would be ready to support such a launch by December 1; MSFC felt it would have no difficulties; MSC needed to look at the differences between spacecraft 103 and 106 (the first spacecraft scheduled to leave earth's atmosphere) and had to find a substitute for the LM. The meeting was concluded at 5:00 p.m. with an agreement to meet in Washington August 14. This would be decision day and, if "GO," Phillips planned to go to Vienna and discuss the plan with Associate Administrator for Manned Space Flight George E. Mueller and NASA Administrator James E. Webb (who were attending a United Nations Conference). Preliminary planning would be secret, but if and when adopted by the agency the plan would be made public immediately.

Still on August 9, in another meeting at MSC at 8:30 p.m., Low met with Kenneth S. Kleinknecht, George Abbey, and C. H. Bolender of MSC, and Dale Myers, North American Rockwell. Bolender left immediately for Bethpage, N.Y., to find a substitute for the LM; and Myers left for Downey, Calif., to get the CM going.

On the following day there were still no obvious insurmountable problems that might block the plan. Kleinknecht was studying the differences between spacecraft 103 and 106, where the high-gain antenna might be a problem. It seemed possible to use LM-2 to support the flight, but Joseph Kotanchik, MSC, suggested flying a simple crossbeam instead of a LM in the event the pogo oscillation problem remained and pointed out that even if pogo was solved the LM would not be needed. Low called Richard and

1968

August

Hage, who agreed with Kotanchik but still wanted mass representation to avoid possible dynamic problems. Low then called William Bergen, of North American, who was not too receptive to the plan.

On August 12 Kraft informed Low that December 20 was the day if they wanted to launch in daylight. With everyone agreeing to a daylight launch, the launch was planned for December 1 with a "built-in hold" until the 20th, which would have the effect of giving assurance of meeting the schedule. LTA (LM test article)-B was considered as a substitute; it had been through a dynamic test vehicle program, and all except Kotanchik agreed this would be a good substitute. Grumman suggested LTA-4 but Low decided on LTA-B.

Kleinknecht had concluded his CSM 103-106 configuration study by August 13 and determined the high-gain antenna was the most critical item. Kraft was still "GO" and said December 20-26 (except December 25) offered best launch times; he had also looked at January launch possibilities. Slayton had decided to assign the 104 crew to the mission. He had talked to crew commander Frank Borman and Borman was interested.

Participants in the August 14 meeting in Washington were Low, Gilruth, Kraft, and Slayton from MSC; von Braun, James, and Richard from MSFC; Debus and Petrone from KSC; and Deputy Administrator Thomas Paine, William Schneider, Julian Bowman, Phillips, and Hage from NASA Hq. Low reviewed the spacecraft aspects; Kraft, flight operations; and Slayton, flight crew support. MSFC had agreed on the LTA-B as the substitute and were still ready to go; and KSC said they would be ready by December 6.

While the meeting was in progress, Mueller called from Vienna to talk to Phillips. He was cool to the proposed idea, especially since it preceded Apollo 7, and urged Phillips not to come to Vienna, adding that he could not meet with the group before August 22. The group agreed they could not wait until August 22 for a decision and agreed to keep going, urging again that Phillips go to Vienna and present their case.

At this point Paine reminded them that not too long before they were making a decision whether to man 503, and now they were proposing a bold mission. He then asked for comments by those around the table and received the following responses: von Braun—Once you decided to man 503 it did not matter how far you went. Hage—There were a number of places in the mission where the decision could be made, minimizing the risk. Slayton—Only chance to get to the moon before the end of 1969. Debus—I have no technical reservations. Petrone—I have no reservations. Bowman—A shot in the arm for manned space flight. James—Manned safety in this and following flights enhanced. Richard—Our lunar capability will be enhanced by flying this mission. Schneider—My wholehearted endorsement. Gilruth—Although this may not be the only way to meet our goal, it enhances our possibility. There is always risk, but this is in path of less risk. In fact, the minimum risk of all Apollo plans. Kraft—Flight operations has

1968**August**

a difficult job here. We need all kind of priorities; it will not be easy to do, but I have confidence. It should be lunar orbit and not circumlunar. Low—Assuming Apollo 7 is a success there is no other choice. After receiving this response, Paine congratulated them on not being prisoners of previous plans and said he personally felt it was the right thing to do. Phillips then said the plan did not represent shortcuts and planned to meet with Mueller on August 22. He reiterated Mueller's reservations, and then agreed to move out on a limited basis, since time was critical.

On August 15 Phillips and Paine discussed the plan with Webb. Webb wanted to think about it, and requested further information by diplomatic carrier. That same day Phillips called Low and informed him that Mueller had agreed to the plan with the provisions that no full announcement would be made until after the Apollo 7 flight; that it could be announced that 503 would be manned and possible missions were being studied; and that an internal document could be prepared for a planned lunar orbit for December.

Phillips and Hage visited MSC August 17, bringing the news that Webb had given clear-cut authority to prepare for a December 6 launch, but that they could not proceed with clearance for lunar orbit until after the Apollo 7 flight, which would be an earth-orbital mission with basic objectives of proving the CSM and Saturn V systems. Phillips said that Webb had been "shocked and fairly negative" when he talked to him about the plan on August 15. Subsequently, Paine and Phillips sent Webb a lengthy discourse on why the mission should be changed, and it was felt he would change his mind with a successful Apollo 7 mission.

Apollo 7—flown October 11–22—far exceeded Low's expectations in results and left no doubts that they should go for lunar orbit on Apollo 8. At the November 10 Apollo Executive meeting Phillips presented a summary of the activities; James gave the launch vehicle status; Low reported on the spacecraft status and said he was impressed with the way KSC had handled its tight checkout schedule; Slayton reported on the flight plan; and Petrone on checkout readiness. Petrone said KSC could launch as early as December 10 or 12. Phillips said he would recommend to the Management Council the next day for Apollo 8 to go lunar orbit. Following are the reactions of the Committee members: Walter Burke, McDonnell Douglas—the S-IVB was ready but McDonnell Douglas favored circumlunar rather than lunar orbit; Hilliard Paige, GE—favored lunar orbit; Paul Blasingame, AC—guidance and navigation hardware was ready, lunar orbit; C. Stark Draper, Massachusetts Institute of Technology—we should go ahead; Bob Evans, IBM—go; George Bunker of Martin, T. A. Wilson of Boeing, Lee Atwood of North American, Bob Hunter of Philco-Ford, and Tom Morrow of Chrysler—lunar orbit.

At the Manned Space Flight Management Council Meeting on November 11 Mueller reported that the proposal had been discussed with the Apollo Executive Committee, Department of Defense, the Scientific and Technical

1968

August

Advisory Committee (STAC), and the President's Science Advisory Committee (PSAC). STAC had made a penetrating review and reacted positively and PSAC was favorably disposed toward the plan but made no firm recommendation.

After a series of meetings, on November 11 Paine said Apollo 8 was to go lunar orbit. The decision was announced publicly the following day. Low's initiative had paid off; the final decision to go to the moon in 1968 was made with the blessings of all of NASA's decision-makers, the Apollo Executive Committee, STAC, and PSAC.

ASPO Manager George M. Low, "Special Notes for August 9, 1968, and Subsequent."

Capping off a considerable exchange of views between MSC and NASA Headquarters, ASPO Manager George Low advised Apollo Program Director Sam Phillips that Houston was going ahead with mission planning that employed a two-burn orbit insertion maneuver. He forwarded to Phillips a lengthy memorandum from one of his staff, Howard W. Tindall, Jr., that explained in detail MSC's rationale for this two-stage orbital maneuver, the most important of which derived from crew safety and simplified orbital mission procedures. The overriding factor, Tindall explained, was a "concern for the consequences of the many things we will not have thought about but will encounter on the first lunar flight. Anything that can be done to keep the dispersions small and the procedures simple provides that much more tolerance for the unexpected. . . . The cost of the two-stage LOI is a small price to pay for these intangible but important benefits."

10

Ltr., George M. Low to Samuel C. Phillips, Aug. 10, 1968, with encl., memo, Tindall to ASPO Manager, "Recommendation to retain the Two-Stage Lunar Orbit Insertion (LOI) Maneuver," Aug. 5, 1968.

Dieter Grau, Director of Quality and Reliability Assurance at MSFC, sent his Houston counterpart Martin Raines a memorandum of understanding covering exchanges of quality surveillance responsibility in support of pogo structural testing under way both in Huntsville, Ala., and at MSC. Testing was being conducted simultaneously at the Wyle Laboratories in Huntsville (under contract to North American Rockwell, primarily static loading and referred to as shell stability tests); and dynamic load testing at MSC (called the "short stack" dynamic tests). In effect, each Center assumed the task of overseeing the complete test article (spacecraft, instrument unit, and S-IVB forward skirt) being tested at its own location.

12

Ltr., Grau to Raines, Aug. 12, 1968, with encl., memorandum of agreement, "Quality Coverage of POGO Structural Testing," Aug. 12, 1968.

George M. Low, MSC, in a letter to Samuel C. Phillips, OMSF, said that the Design Certification Review (DCR) for spacecraft 101 had been completed; that assigned action items had been resolved; and most of the open items had been closed. Several open issues would be closed at the 101 Flight Readiness

13

1968
August

Review. Low said: "The MSC subsystem managers have reviewed all the documentation supporting the DCR. I have reviewed the statements of certification by the North American and MSC subsystem managers. I have personally watched the design of Spacecraft 101 develop to a stage of maturity. As a result, I am taking this opportunity to certify that Spacecraft 101 is ready to perform the Apollo 7 mission once the open items are closed."

Ltr., Low to Phillips, "Design Certification of Apollo 7," Aug. 13, 1968.

16

NASA Associate Administrator for Manned Space Flight George E. Mueller reported to his superiors that launch preparations for the Apollo 7 mission were running ahead of schedule. Spacecraft 101 had been erected and mated with the launch vehicle on August 9. Integrated systems testing had begun on August 15. Preparation for the next mission, Apollo 8, were not proceeding as well. Checkout of the launch vehicle and CSM 103 were on schedule, but work on LM-3 was some seven days behind schedule. Though LM-3's problems were under intensive investigation, they were directly holding up the simulated mission run and transfer to the altitude test chamber.

Memo, Mueller to Administrator, "Manned Space Flight Weekly Report—August 16, 1968."

17

ASPO Manager George M. Low wrote Program Director Samuel C. Phillips seeking to halt further development of a pogo sensor for the CSM. (MSC had undertaken development of the device shortly after the *Apollo 6* flight as "insurance" should the sensor prove necessary.) No requirement for a pogo sensor had been identified, said Low. In fact, it was by no means certain how the sensor could be used in flight. Because MSFC was highly confident that the pogo problem encountered on *Apollo 6* had been solved, and because no abort criteria could be based on pogo alone, Low argued against the sensor. Even in the unlikely event that pogo occurred on the next Saturn V flight, he argued against an abort unless there was a catastrophic effect on the launch vehicle, in which case abort would be effected using normal abort criteria. For these reasons, no pogo sensor was to be installed on the CSM. A week later, Phillips approved Low's recommendation to halt the pogo sensor development.

Ltrs., Low to Phillips, Aug. 17, 1968; Phillips to Low, Aug. 24, 1968.

19

In a Mission Preparation Directive sent to the three manned space flight Centers, NASA Apollo Program Director Samuel C. Phillips stated that the following changes would be effected in planning and preparation for Apollo flights:

Apollo-Saturn 503

- Assignment of Saturn V 503, CSM 103, and LM-3 to Mission D was canceled.

1968

August

- Saturn V 503 would be prepared to carry CSM 103 and LTA (LM test article)-B on a manned CSM-only mission to be designated the C prime mission.
- The objectives and profile of the C prime mission would be developed to provide maximum gain consistent with standing flight safety requirements. Studies would be carried out and plans prepared so as to provide reasonable flexibility in establishing final mission objectives.
- All planning and preparations for the C prime mission would proceed toward launch readiness on December 6, 1968.

Apollo-Saturn 504

Saturn V 504, CSM 104, and LM-3 were assigned to the D mission, scheduled for launch readiness no earlier than February 20, 1969. The crew assigned to the D mission would remain assigned to that mission. The crew assigned to the E mission (Frank Borman, James A. Lovell, Jr., and William Anders) would be reassigned to the C prime mission. Training and equipping the C prime crews and operational preparations would proceed as required to meet mission requirements and to meet the newly established flight readiness date.

A memorandum from the ASPO Manager on September 3 summarized the basic and alternate missions for which detailed planning and preparation would be performed. In the basic earth-orbital C prime mission the vehicle configuration would consist of the Saturn V 503 with a payload of 39 780 kilograms (CSM 103 and LTA-B with the service propulsion subsystem fully loaded). Insertion would be into low circular orbit of the earth. The earth-parking-orbit activities would include crew and ground support exercises related to spacecraft system checkout and preparation for translunar injection (TLI; i.e., transfer into a trajectory toward the moon). CSM separation maneuver would occur before TLI.

Alternate earth-orbital missions would include a manned TLI burn to a 6440-km apogee or an SPS burn to achieve a 6440-km apogee. An alternate lunar orbit mission would include mission planning, crew training, spacecraft hardware, and software to support the mission. In providing support, top priority would be assigned to the lunar orbit mission. The memo indicated that following TLI, simulated transposition and docking maneuvers would be conducted; midcourse corrections and star horizon/star landmark sightings would be performed during the translunar coast; lunar orbit insertion would be accomplished and a lunar parking orbit established for 20 hours.

On September 13, MSC Director of Flight Operations Christopher C. Kraft affirmed that the impact of supporting the described mission plan had been assessed and no constraints were seen to prevent meeting the launch readiness date. He added that the lunar parking orbit would be established

1968
August

during the course of two elliptic orbits and would be of 16 hours duration, thus giving a total lunar vicinity time of 20 hours.

Ltr., Phillips to Directors, KSC, MSFC, and MSC, "Apollo Mission Preparation Directive," Aug. 19, 1968; memos, Manager, ASPO, to distr., "C Prime Mission," Sept. 3, 1968; MSC Director of Flight Operations to Manager, ASPO, "C Prime Mission," Sept. 13, 1968.

26

ASPO Manager George M. Low asked Joseph N. Kotanchik, head of the Structures and Mechanics Division, to verify that all spacecraft load analyses and safety factors were compatible with the recently-agreed-on payload weight of 39 780 kilograms for the AS-503 mission. Low passed along the concern voiced by Lee B. James, Saturn V Program Manager at MSFC, that the problem of an S-IC engine failure in the Saturn launch vehicle might be more severe for the 503 mission than for a heavier payload. Had adequate stress analysis been done on the high-gain antenna attachments and its support inside the adapter? When would pogo dynamic analysis of the actual 503 payload be completed? And finally, what was the situation regarding loads on LTA-B, the LM test article to be substituted in place of an actual lunar lander aboard the flight?

Memo, Low to Kotanchik, "AS-503 Loads," Aug. 26, 1968.

27

George M. Low, ASPO Manager, set forth the rationale for using LTA-B (as opposed to some other LM test article or even a full-blown LM) as payload ballast on the AS-503 mission. That decision had been a joint one by Headquarters, MSFC, and MSC. Perhaps the chief reason for the decision was Marshall's position that the Saturn V's control system was extremely sensitive to payload weight. Numerous tests had been made for payloads of around 38 555 kilograms but none for those in the 29 435- to 31 750-kilogram range. MSFC had therefore asked that the minimum payload for AS-503 be set at 38 555 kilograms. Because LTA-B brought the total payload weight to 39 780 kilograms, that vehicle had been selected for the Apollo 8 mission. All dynamic analyses in connection with the pogo problem had to be verified, but MSFC engineers were not concerned that the established weight would affect pogo performance. Because NASA had been prepared to fly AS-503 with a heavier payload—i.e., originally including LM-3—Low saw "no reason to be concerned about the decision made to fly the somewhat lighter and more symmetrical LTA-B."

Memo, Low to Joseph N. Kotanchik, MSC, "Use of LTA-B for AS-503," Aug. 27, 1968.

28

NASA asked Grumman to make a detailed study of LM-4 to determine any constraints that might prevent accomplishment of a lunar orbit mission. All such constraints were to be defined in sufficient detail to facilitate a NASA review, and NASA expected Grumman-recommended action in each case. The information was requested before the LM-4 Customer Acceptance Readiness Review. Grumman was further asked to study LM-5 to determine

constraints that might prevent accomplishment of the lunar landing mission. Again, all constraints were to include recommended action.

1968

August

Ltr., Frank X. Battersby, RASPO, to Joseph Gavin, LM Program Director, Grumman, Aug. 28, 1968.

Eberhard Rees, Director of the Apollo Special Task Team at North American Rockwell, notified the contractor that facilities the team had used at Downey, Calif., were relinquished to the company. Thus ended the mission of the group formed some nine months earlier to oversee the contractor's preparations during the period of adjustment following the Apollo 1 accident.

30

Ltr., Rees to C. F. Wetter, Aug. 30, 1968.

Apollo Program Director Samuel C. Phillips notified the three manned space flight Centers that the Apollo 8 launch readiness working-schedule date had been changed to December 13, 1968.

September

3

TWX, Phillips to MSC, KSC, MSFC, "Apollo 8 (AS-503) Launch Readiness Working Schedule," Sept. 3, 1968.

In response to a letter from Apollo Program Director Samuel C. Phillips concerning proposed revisions of the first lunar landing mission plan, MSC Director Robert R. Gilruth presented MSC's position on the three major topics: (1) deletion of the lunar geology investigation (LGI) and the Apollo Lunar Surface Experiments Package (ALSEP), (2) television coverage, and (3) extravehicular excursion.

6

Concerning the first item, Gilruth said, "Our lunar surface exploration and scientific activities should be progressive as we extend our knowledge and obtain a better understanding of operational limitations and capabilities in a $\frac{1}{6}$ g environment. . . . By embarking on too ambitious an effort on our first mission, we may well jeopardize our capability to accomplish manned . . . activities on subsequent flights. . . ." It was "recommended that the LGI (with the exception of the contingency sample and preliminary sample portion) and the ALSEP be deleted from the first lunar landing mission."

With reference to television coverage, Gilruth cited Houston's position that "it would be extremely desirable to provide adequate television coverage during the extravehicular excursion. Coverage can be obtained through the LM steerable antenna and the Goldstone 210-foot [64-meter] antenna while in view of Goldstone." MSC proposed to provide "the capability to transmit the television signal directly through the high gain antenna; but we would also like to maintain the capability to carry the erectable antenna, in the event that it will not be feasible to adjust the timeline to provide Goldstone coverage for all planned extravehicular activities. . . ."

1968
September

On the subject of extravehicular excursion, he said, “. . . we strongly believe that, on the first lunar landing mission, only a single extravehicular activity should be carried out. You have stated that the simplest and safest excursion should be conducted by one man alone. However, it is clear that we have to maintain the basic capability for a two-man excursion so that the second man can assist the first in the event of trouble or difficulties. Also, further studies and simulations in this area might identify new reasons why a planned two-man excursion is more desirable than a one-man excursion. . . .”

Gilruth said that MSC officials Charles A. Berry, Maxime A. Faget, Christopher C. Kraft, Jr., George M. Low, and Donald K. Slayton were in full accord with all of these recommendations. He added, however, that Wilmot N. Hess felt that “these changes represent a serious compromise to the scientific program.” Hess felt that the EVA period should be open ended and that it would be worthwhile to carry ALSEP and attempt its deployment. Hess also recommended that if a decision were made not to carry ALSEP, some easily deployed contingency experiments might be added, such as: Solar Wind Composition experiment, High-Z Cosmic Ray experiment, and a simplified Corner Reflector for Laser Ranging experiment.

Gilruth said that he himself believed, “that it is essential that EVA on the first lunar landing mission be limited to a single excursion and that ALSEP and LGI be eliminated as experiments from that flight. . . . I believe that the maximum scientific gains on this and future missions will be achieved if we limit our objectives as proposed. . . . I am sure that all will agree that if we successfully land on the moon and return to earth, bring back samples of lunar soil, transmit television directly from the moon, and return with detailed photographic coverage, our achievement will have been tremendous by both scientific and technological standards.”

Ltr., Gilruth to Phillips, “Proposed revisions to the first lunar landing mission plan,” Sept. 6, 1968.

10 ASPO Manager George M. Low advised Headquarters of the status of MSC’s work on action items assigned as a result of the Apollo Crew Safety Review Board presentation on June 17. Among those items were:

1. Switching procedures for the emergency detection system—the crew would manually disable the automatic abort device at 1 minute 40 seconds after liftoff.
2. High-altitude abort procedures—these procedures were being reevaluated by the CSM 101 crew on the spacecraft simulator; following completion (scheduled for September 23), a decision would be made whether to retain the procedure for optional tower jettison.
3. Rescue of an incapacitated crew—emergency access procedures were being demonstrated at Downey using CSM 008. Any procedural revisions required would be made accordingly.

Completion of these actions, said Low, fulfilled the recommendations of the Crew Safety Review Board.

1968

September

Ltr., Low to Samuel C. Phillips, "Actions from Apollo Crew Safety Review Board and Presentation," Sept. 10, 1968.

The Apollo Crew Safety Review Board, headed by William C. Schneider, met for the third time at MSFC, a meeting devoted primarily to safety factors for the Saturn V launch vehicle. Of particular concern was the capability to shut down the vehicle during the period between ignition and liftoff should some problem arise (it could be shut down by several methods, including both manual and automatic engine shutdown). The Board also reviewed in detail Saturn V modifications that had eliminated more than 50 engine and electrical circuitry potential single-point failures (primarily through increased redundancy and circuitry checkout). Similarly the Board examined the reliability of guidance failure indicators and checkout of the emergency detection system during the final portion of the countdown. No additional action was needed, members concluded, because all functions in the launch vehicle were checked during the terminal count and tank pressure gauges were checked out by disconnecting the transducers and testing them individually several days before launch.

10-11

At the end of the meeting, Board members attended the POGO Management Review, where they were favorably impressed by the optimism among Saturn V program officials that the pogo problem had been solved (although contingency planning for a pogo occurrence should continue through AS-503).

Ltr., Schneider to distr., "Minutes of Third Meeting on September 10-11, 1968, at Marshall Space Flight Center," Sept. 16, 1968.

At a meeting of the MSF Management Council, Apollo Program Director Samuel C. Phillips put forth a number of recommendations regarding planning for extravehicular and scientific activities during the first lunar landing missions:

11

- During the first mission, extravehicular activities (EVA) should be limited to three hours, with the spacecraft manned by one of the two crewmen at all times.
- The Apollo Lunar Surface Experiments Package should be deleted from the earliest missions (although the present preliminary sample must be improved scientifically).
- Television must be carried aboard the LM, for benefits both for operational and public information.
- To realize the maximum scientific return on the second and subsequent flights, MSC must, during the first landing mission, assess the astronauts' capabilities to conduct lunar surface activities. Also, MSC

1968
September

should study and recommend changes in LM hardware that would lengthen EVA time available for scientific investigations during future Apollo missions.

The Management Council approved Phillips' recommendations and carried them to Administrator James E. Webb for final approval. In

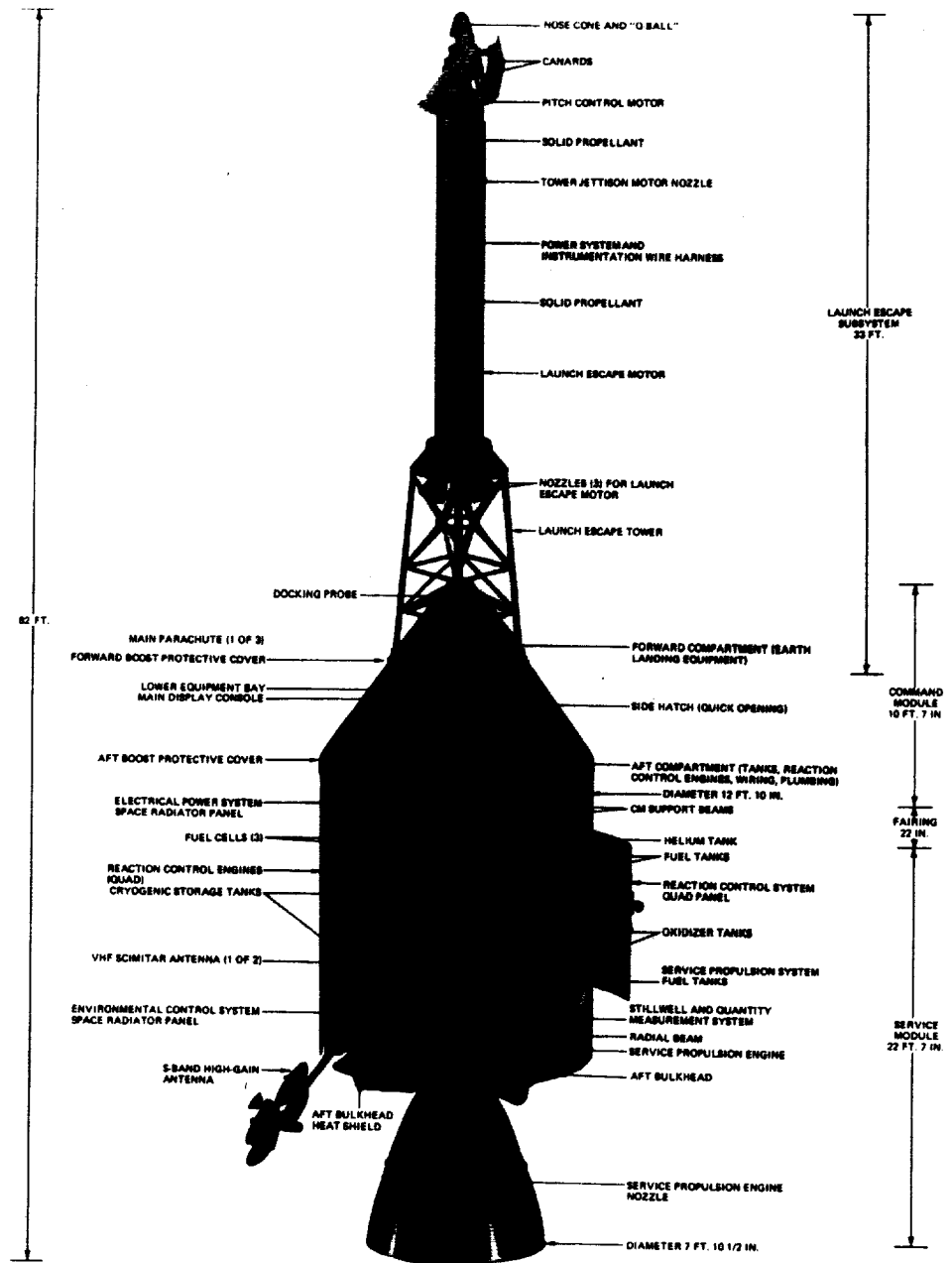

A cutaway view of the Block II CSM configuration and launch escape system shows some of the components.

1968
September

Houston, ASPO Manager George M. Low ordered his organization to begin planning for the first landing mission in accordance with these recommendations.

Memo, Low to O. E. Maynard, "G Mission Planning," Sept. 13, 1968.

Dale D. Myers, North American Rockwell's Apollo CSM Program Manager, wrote George M. Low: "With the recent shipment of CSM 101 to KSC and preparations for the first manned Apollo flight, attention is centered on the various aspects of crew safety. In this regard, I recently instructed our system safety people to review the action items that resulted from the S/C 012 fire [January 27, 1967], identify those with safety content or implications, determine what corrective action had been accomplished, and assess the adequacy of the closeout actions." Myers went on to say that out of a total of 137 North American action items, 70 were related to safety; and combining similar and identical items resulted in identification of 41 specific safety-oriented action items. An exhaustive study by safety personnel had indicated that all items had been closed out and that corrective actions were adequate.

Ltr., Myers to Low, ASPO, MSC, Sept. 12, 1968.

Apollo Program Director Samuel C. Phillips formally notified ASPO Manager George M. Low at MSC and Saturn V Program Manager Lee B. James at MSFC of changes in the Apollo Program Specification. As agreed on during the MSF Management Council meeting on August 6, the Apollo payload interface was set at 46 040 kilograms (with a flight geometry reserve of 137 kilometers per hour). Also, the present spacecraft loading philosophy allowed a total spacecraft weight of 46 266 kilograms for lunar missions having less than maximum flight geometry requirements. Phillips repeated his earlier statement that he was prepared to relax some flight constraints to achieve the best possible balance on each space vehicle. (Although with recent changes in Saturn V loading, residuals, and J-2 engine thrust, apparently few if any of these constraints would have to be relaxed.)

Ltr., Phillips to James and Low, "Apollo Program Specification Changes," Sept. 16, 1968.

Ernest B. Nathan, MSFC Cochairman of the Saturn-Apollo Flight Evaluation Panel, sent to MSC Marshall's requirements for the flight crew debriefing for the AS-205 mission. Generally, these requirements called for the crew's visual and sensory evaluation of the launch vehicle's performance and behavior.

Ltr., Nathan to Helmut A. Kuehnel, MSC, Sept. 17, 1968, with encl., "MSFC Flight Crew Debriefing Requirements, AS-205/SC-101 Mission."

Dale D. Myers, Apollo CSM Program Manager at North American Rockwell, wrote to CSM Manager Kenneth S. Kleinknecht at MSC to apprise him of the company's response to an earlier review of the CSM subsystems development program. During February a small task team from MSFC, headed by William A. Mrazek, had surveyed the design, manu-

1968**September**

facture, and checkout of several of the spacecraft's subsystems. Findings of the team had been reviewed with Eberhard F. M. Rees, then at Downey as head of the Apollo Special Task Team. Myers sent Kleinknecht briefing notes of a presentation to Rees and others of the special team describing North American's responses to specific issues raised by Mrazek's group. These issues, Myers reported, had been resolved to the satisfaction of both contractor and customer.

Ltr., Myers to Kleinknecht, Sept. 18, 1968.

18

ASPO officials headed by Manager George M. Low met with spacecraft managers from North American Rockwell and Grumman to discuss configuration management for the remainder of the Apollo program and to set forth clear ground rules regarding kinds of changes (described as Class I and Class II) and the requisite level of authority for such changes. The outcome of this meeting, as Low told Apollo Program Director Samuel C. Phillips, was that MSC would pass judgment on all Class I changes and that "nearly every change [would] fall in this category." Minor design changes might still be approved at the contractor or subcontractor levels, said Low, but MSC would judge whether those changes were indeed Class II changes. The overall result of this policy, he told Phillips, would be a better awareness by NASA of all changes made by spacecraft subcontractors and a firm understanding that only NASA could approve Class I design modifications.

Ltr., Low to Phillips, Sept. 19, 1968.

23

The Apollo Guidance Software Task Force, which NASA Associate Administrator for Manned Space Flight George E. Mueller had convened in December 1967, submitted its final report. Purpose of the task force, as Mueller had stated at the time, was to determine whether "additional actions . . . could be taken to improve the software development and verification process and control of it." Between December and July 1968, the group met 14 times at NASA and contractor locations to review the historical evolution of software programs within the Apollo project. Because of the great complexity of this entire field, the task force members recommended that it continue to receive attention by top management levels at both MSC and MSFC. And drawing upon experience learned in the Apollo program, the task force recommended that software not be slighted during any advanced manned programs and that adequate resources and experienced personnel be assigned early in the program to this vital and easily underestimated area.

Ltr., Mueller to Harold T. Luskin, Apollo Applications Program Director, NASA, Sept. 23, 1968, with encl., "Final Report: Apollo Guidance Software Task Force," Sept. 23, 1968.

24

Samuel C. Phillips announced membership of the OMSF Apollo Site Selection Board, which was to meet September 26: Phillips, chairman; Lee R. Scherer, OMSF, secretary; John D. Stevenson and Harold D. Luskin, both of OMSF; Oran W. Nicks, NASA Hq., John D. Hodge, Owen E.

Maynard, and Wilmot N. Hess, all of MSC; Ernst Stuhlinger, MSFC; and Roderick O. Middleton, KSC. J. H. Turnock and Charles W. Mathews had been deleted from the previous membership list and Hodge, Luskin, and Scherer added.

1968
September

Memo, Apollo Program Director to distr., "Membership of the OMSF Apollo Site Selection Board," Sept. 24, 1968.

Apollo Program Director Samuel C. Phillips wrote to his two principal counterparts at MSFC and MSC, Lee B. James and George M. Low, to express his concern that the launch-release wind constraint for the Saturn IB, currently 45 kilometers, was perhaps the most restrictive of all such constraints. Phillips emphasized his need for a complete understanding of all tradeoffs associated with this figure, to allow a real-time estimate of the requirement to hold. He asked James and Low to summarize for him several such tradeoffs before the Apollo 7 flight readiness review: wind versus safety, velocity versus direction, and conservative assumption versus technical accuracy. Also, he asked for criticality and failure mode for each of the above tradeoffs to allow a technical evaluation of increasing the 45-kilometer constraint. At the same time, he asked that a similar effort be initiated for the Saturn V.

24

TWX, Phillips to Low and James, "Apollo Saturn Release Wind Constraints," Sept. 24, 1968.

NASA Resident ASPO Manager Wilbur H. Gray at Downey told Dale D. Myers, North American Rockwell CSM Manager, that NR quality coverage of spacecraft testing no longer provided NASA with confidence in test results and that NASA Quality Control would return to monitoring test activities in and from the ACE (acceptance checkout equipment) control room. Gray charged that North American had progressively backed away from contractually agreed steps of the November 30, 1967, Quality Program Plan, and that these actions had affected test readiness, testing, and trouble shooting to the point that test acceptance could not be accepted with any reasonable assurance. Gray said that—unless North American responded by immediate reinstatement of the procedures which, as a minimum, were those that worked satisfactorily on CSMs 103 and 104—NASA formal acceptance of operational checkout procedures would be discontinued and contractual action initiated. An annotation to George Low from Kenneth S. Kleinknecht, MSC's CSM Manager, indicated the letter had been written with the concurrence and at the suggestion of Kleinknecht.

25

Myers replied: "I regret that NASA feels any lack of confidence in current test results. . . . For the past year, there has been a constant improvement program carried out in Test Quality Assurance to (1) perform quality evaluation and acceptance of test results in real time and (2) upgrade the test discipline to be consistent with good quality practice. I believe that this improvement program has been effective and is evidenced by the current efficiency of test and expedient manner in which test paper work is being closed out. While there is naturally some cost benefit experienced from the

1968
September

successful improvements, cost never has been placed as a criteria above quality. . . .

“Again, I want to emphasize that the CSM Program has not nor will not intentionally place cost ahead of quality. . . . The procedures which worked satisfactorily on CSM 103 and 104 are being improved to provide better test discipline and more effective Quality Assurance coverage. Test progress on CSM 106 to date indicates a greater test effectiveness and a greater confidence in test results than any previous CSM’s.”

Ltr., Gray to Myers, Sept. 25, 1968; annotation, Kleinknecht to Low, Sept. 26, 1968; ltr., Myers to Gray, Oct. 17, 1968.

25

The LM ascent engine to be flown in LM-3 and subsequent missions would incorporate the Rocketdyne injector, Apollo Program Director Phillips informed ASPO Manager Low. The engine would be assembled and delivered by Rocketdyne under subcontract to Grumman. MSC was authorized to inform those concerned of these decisions but would not issue contractual direction until an agreed course of contractual action had been approved by NASA Hq. Two days later, on September 27, Phillips advised Low that MSC was authorized to take all proper contract actions to implement the decision to contract with Grumman for ascent-stage engines assembled by Rocketdyne with the latter’s injector.

TWXs, NASA Headquarters to MSC, Attn: George Low, “LM Ascent Engine Program Decision,” Sept. 25, 1968; and “LM Ascent Engine Program,” Sept. 27, 1968.

26

MSC Director Robert R. Gilruth sent Eberhard F. M. Rees, MSFC Deputy Director, his “personal commendation” and appreciation for Rees’s leadership of the Apollo Special Task Team and its efforts to bring the CSM program out of the difficult period early in 1967. The work of Rees and his group, said Gilruth, had made an outstanding contribution to the Apollo program and had given NASA management “a significantly higher level of technical confidence” that the Block II spacecraft could safely perform its mission. In addition, Gilruth noted, Rees’s “diplomacy in interfacing with North American management also created a much better NASA-contractor relationship and mutual understanding of program technical requirements.”

Ltr., Gilruth to Rees, Sept. 26, 1968.

Week
Ending
September
27

The Allison descent-stage propellant tank, being redesigned at Airite Division of Sargent Industries to a “lidless” configuration, blew up during qualification test at Airite. The crew noticed loss of pressure and therefore tightened fittings and repressurized. As the pressure went up, the tank blew into several pieces. Grumman dispatched a team to Airite to determine the cause and the necessary corrective action.

Memo, Frank X. Battersby, RASPO, Bethpage, to Chief, Apollo Procurement Br., Procurement and Contracts Div., MSC, “Weekly Activities Report, BMR, Bethpage, Week Ending September 27,” Oct. 3, 1968.

1968
September
28

Results of a joint MSFC-MSD review of functional interfaces between the launch vehicle and spacecraft for Apollo 7 were forwarded to NASA Hq. (The review had originally been requested by the Apollo 7 Crew Safety Review Board, headed by John D. Hodge.) The two Centers had tackled the task by identifying all electrical wiring between payload and booster, the requirement for each wire, a verification that the circuits indeed satisfied requirements, and an evaluation of the adequacy of test and checkout procedures. Several months of investigation, reported Teir and Low, had uncovered no areas of concern. Definition and function of the CSM instrument unit were both accurate and valid and ensured flight readiness.

Ltr., Saturn IB Manager William Teir, MSFC, and ASPO Manager George M. Low, MSC, to Samuel C. Phillips, NASA Hq., "Apollo 7 Launch Vehicle to Spacecraft Functional Interface Review," Sept. 28, 1968, with encl., "AS-205 Launch Vehicle/Spacecraft (LV/SC) Electrical Interface Review."

NASA Associate Administrator for Manned Space Flight George E. Mueller summarized for his superiors launch preparation for the near-term missions Apollo 7 and Apollo 8:

30

- Apollo 7—Space vehicle testing was on schedule (despite a delay in start of the flight readiness test caused by a liquid hydrogen leak due to a faulty pneumatic valve). The flight readiness test began on September 25 and went smoothly through T minus 0 two days later. Countdown for launch would begin as scheduled on October 6, leading to launch readiness on October 11.

- Apollo 8—Both launch vehicle (503) and spacecraft (103) were several days behind schedule. CSM 103 was tested in the altitude chamber while manned by the prime and backup crews on September 20 and 22. The spacecraft was undergoing several modifications and equipment installations (including the high-gain antenna, which was delivered to KSC on September 23); KSC and contractor technicians also were making leak and functional checks on the S-II stage and subsystem checks on the S-IVB stage of the launch vehicle. Rollout of the space vehicle from the assembly building to the pad was planned for October 10.

Memo, Mueller to Administrator and Deputy Administrator, "Manned Space Flight Weekly Report—September 30, 1968," Sept. 30, 1968.

Apollo Program Director Samuel C. Phillips asked ASPO Manager George M. Low to investigate the feasibility of using data from the D and G missions to increase NASA's knowledge of and confidence in the operational capabilities of the extravehicular mobility unit (EMU). Phillips included in his request specific recommendations for additional instrumentation to obtain the necessary data. His action stemmed from a general concern about the extent and complexity of surface operations on the first lunar landing flight (which might substantially reduce chances for successful completion). For this reason, he and other program officials had stringently limited the number of objectives and the extent of those surface activities. But to plan confidently for surface EVA during follow-on Apollo

30

- 1968**
September
- landing missions, Phillips said, as much information as possible had to be gathered about the operational capability of the crew and the EMU.
- Ltr., Phillips to Low, "Data for an EVA Capability Assessment," Sept. 30, 1968.
- October**
1-2
- The Apollo Crew Safety Review Board held its fourth meeting at MSC. Discussions centered chiefly on Saturn V engine-out abort situations and the ability of the CSM to withstand structural loads imposed by such vehicle failures. In fact, however, it was unlikely that any problem would be experienced, because of a controlled S-IC engine shutdown. Loads because of catastrophic engine failure greatly exceeded spacecraft capability, but the Board ruled such an occurrence as remote and accepted it as a flight risk. Also, evaluation of testing results demonstrated that overall loads because of pogo vibration were not a problem. Board Chairman William C. Schneider reported that, in general, action items assigned to MSC as a result of the Apollo 7 review had been satisfactorily closed.
- Ltr., Schneider to distr., "Minutes of Fourth Meeting on October 1-2, 1968, at the Manned Spacecraft Center," Oct. 11, 1968.
- 2**
- George E. Mueller, NASA Associate Administrator for Manned Space Flight, wrote MSC Director Robert R. Gilruth to reemphasize the operational philosophy for the Apollo 7 mission. That flight, Mueller said, was the first in the manned program—including Mercury and Gemini programs—to employ fully the "open ended" mission concept. Rather than the Gemini process, in which a series of missions verified the spacecraft design for 3, 6, and ultimately 14 days, with Apollo 7 the first flight was to verify the CSM, evaluating the vehicle via telemetry through each successive mission step. Also, to ensure maximum return from the mission, primary and secondary objectives would be completed as early in the flight as possible (approximately two-thirds of those objectives to be completed by the end of the first day and more than 90 percent by end of the second day). Mueller emphasized the importance of the agency's emphasizing this open-ended mission concept during public announcements of Apollo 7's flight plan and objectives.
- Ltr., Mueller to Gilruth, Oct. 2, 1968.
- 3**
- Senior management from NASA Hq. and the three manned Centers conducted the Apollo 7 flight readiness review at KSC. Crew, space vehicle, and all supporting elements were ready for flight. Countdown-to-launch sequence had started on October 6, and flight preparations were on schedule for launch readiness at 11:00 a.m. EDT on October 11.
- OMSF, NASA Hq., to NASA Administrator and Deputy Administrator, "Manned Space Flight Weekly Report—October 7, 1968," Oct. 7, 1968.
- 4**
- MSC spacecraft and mission planning experts met to discuss mission techniques for the D mission, specifically the rendezvous exercise. Because of the slow progress in reviewing a draft of the D Rendezvous Mission

1968
October

Techniques document, Apollo Data Priority Coordinator Howard W. Tindall reported that the Center's effort in this area needed to be strengthened. Participants did identify exactly what spacecraft equipment had to be working at the start of each segment of the rendezvous exercise. A general principle was that the CSM must at all times be prepared to rescue the LM. Participants therefore insisted on having a redundant capability in the CSM for all crucial operations. This rescue capability by the CSM provided an adequate backup for each possible LM system failure except braking. This general philosophy, stated Tindall, "seemed to provide the best tradeoff between crew safety and assurance of meeting mission objectives."

Memo, Tindall to distr., "D Rendezvous Mission Techniques," Oct. 10, 1968.

In preparation for the flight of Apollo 8, NASA and industry technicians at KSC placed CSM 103 atop the Saturn V launch vehicle. The launch escape system was installed the following day; and on October 9 the complete AS-503 space vehicle was rolled out of the Vehicle Assembly Building and moved to the launch pad, where launch preparations were resumed.

7

Memo, George E. Mueller, NASA Associate Administrator for Manned Flight, to Acting NASA Administrator, "Manned Space Flight Weekly Report—October 14, 1968," Oct. 14, 1968.

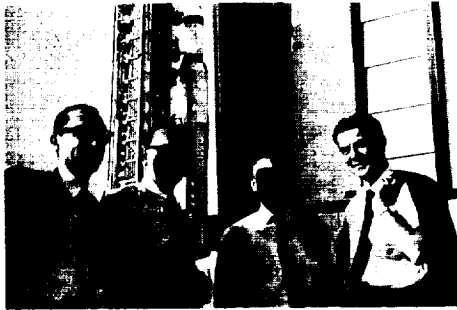

NASA officials watch the rollout of the AS-503 space vehicle at Kennedy Space Center October 9, 1968. In December the vehicle would launch Apollo 8 on the first manned mission to orbit the moon. Left to right are George E. Mueller, NASA Associate Administrator for Manned Space Flight; MSC Director for Flight Operations Christopher C. Kraft, Jr.; and Charles J. Donlan and Charles W. Mathews, both deputies to Mueller.

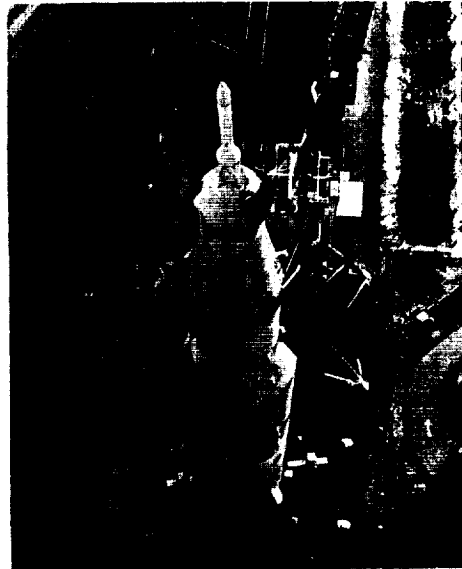

1968
October
7

Ralph H. Tripp, LM Program Manager at Grumman, forwarded his company's plan for control of configuration changes on the LM. The need for such a formal statement had been discussed at a meeting in Bethpage on September 25 between ASPO Manager George M. Low; his deputy for the LM, C. H. Bolender; other Apollo engineers from Houston; and Tripp, LM Program Director Joseph G. Gavin, Jr., and others from Grumman. Grumman's ground rules set forth explicit guidelines governing change approval levels, specifically those changes which the contractor might make without obtaining prior specific approval from NASA (defined as "compatibility changes" that did not have significant cost, weight, performance, schedule, or safety effects)—although Grumman must continue to inform MSC of these changes as they occurred.

Ltr., Tripp to Low, "Configuration Change Control, LM Program," Oct. 7, 1968, with encl., "Configuration Change Control—Ground Rules," Oct. 7, 1968.

- 7** In compliance with Apollo Program Directive 29 of July 6, 1967, ASPO Manager George M. Low informed Apollo Program Director Samuel C. Phillips that "the private umbilical connection between the astro-communicator and the astronauts, the private administrative telephone connection via the umbilical cable to the astronauts, and the private aeromed communications in the MSOB [Manned Spacecraft Operations Building] will be recorded during all hazardous spacecraft tests. The recording will be placed in the hands of the Director of Flight Crew Operations, who will keep this recording for a period of 30 days following mission completion. After that time the recording may be destroyed."

Ltr., Low to Phillips, Oct. 7, 1968; TWX, Phillips to Low, "Recording of Voice Communications at KSC," Sept. 30, 1968.

- 9** Members of the MSF Management Council considered scientific experiments and surface extravehicular activities (EVA) for the first Apollo lunar landing mission. They decided to go ahead with development of three proposed experiments, the passive seismometer, laser reflector, and solar wind collector. They made no commitment to fly any of the three, however, pending development schedules and a clear understanding of timelines required for their deployment during the EVA portion of the mission. Other issues examined by the Council still were unresolved: one versus two-man EVA, use of television, and timeline allocations for EVA trials and development by the crew. During the discussions, ASPO Manager George M. Low recommended attempting television transmission via the Goldstone antenna (although the operational procedures would further burden an already heavily constrained mission). The erectable antenna would also be carried and used if the landing site and EVA period precluded sight of the Goldstone antenna. Charles W. Mathews and others from Washington voiced concern that the EVA timeline did not allow sufficient time for learning about EVA per se in the one-sixth-gravity environment of the moon. The astronaut must perform some special tasks, but must also have some time for personal movements and evaluation of EVA capabilities in

1968
October

order to build confidence toward a fairly complex EVA exercise during the second landing mission. Low asked his chief system engineering assistant, Owen E. Maynard, to incorporate these operational decisions into the Apollo mission planning and to define mounting of the television camera and its early use in the mission.

Memo, Low to Maynard, "First G mission science package," Oct. 9, 1968.

NASA Apollo Mission Director William C. Schneider reported completion of all action items pertinent to Apollo 7 assigned by Apollo Program Director Samuel C. Phillips as a result of recommendations by the Apollo Crew Safety Review Board on May 27, 1968. These actions had included qualification of critical subsystems; a review of the AS-205 launch vehicle test history; a review of Saturn IB 205 and CSM 101 functional interfaces; a manned test readiness review, which was completed at KSC on August 28; and issuance of an Emergency Actions Summary Document containing emergency and contingency situations and appropriate procedures for pad operations, which had won approval on September 27.

Memo, Schneider to Flight Readiness Review Secretariat for Apollo, "Crew Safety Review Board Action," Oct. 9, 1968.

Because of the continuing problem of hardware changes, Apollo Program Director Samuel C. Phillips revised policies and procedures for control of changes for AS-503 and subsequent missions. Level II Configuration Control Boards, said Phillips, would have authority to implement several categories of engineering changes: mandatory changes to ensure crew safety or mission success, changes that would substantially reduce workload or checkout time at KSC, and changes to improve the probability of launch and to reduce the possibility of launch delays or scrubs, based on engineering analysis and failure history. Phillips admitted that other essential changes might be needed that did not fulfill these criteria, but such "down-the-line" changes must be held to an absolute minimum, he told ASPO Manager George M. Low. All changes that affected deliveries or launch schedules, on the other hand, must still be submitted to the Level I CCB for approval before implementation. These revised procedures, Phillips believed, would produce the control of changes needed to ensure an operationally suitable Apollo space vehicle, yet allow the secondary-level CCB to exercise "tough and critical judgment" of the change decision process, to allow needed flexibility within the overall program.

Ltr., Phillips to Low, "Change Policies and Procedures," Oct. 10, 1968.

Apollo 7 (AS-205), the first manned Apollo flight, lifted off from Launch Complex 34 at Cape Kennedy Oct. 11, carrying Walter M. Schirra, Jr., Donn F. Eisele, and R. Walter Cunningham. The countdown had proceeded smoothly, with only a slight delay because of additional time required to chill the hydrogen system in the S-IVB stage of the Saturn launch vehicle. Liftoff came at 11:03 a.m. EDT. Shortly after insertion into orbit, the S-IVB

1968
October

stage separated from the CSM, and Schirra and his crew performed a simulated docking with the S-IVB stage, maneuvering to within 1.2 meters of the rocket. Although spacecraft separation was normal, the crew reported that one adapter panel had not fully deployed. Two burns using the reaction control system separated the spacecraft and launch stage and set the stage for an orbital rendezvous maneuver, which the crew made on the second day of the flight, using the service propulsion engine.

Crew and spacecraft performed well throughout the mission. During eight burns of the service propulsion system during the flight, the engine functioned normally. October 14, third day of the mission, witnessed the first live television broadcast from a manned American spacecraft. The SPS engine was used to deorbit after 259 hours 39 minutes of flight. CM-SM separation and operation of the earth landing system were normal, and the

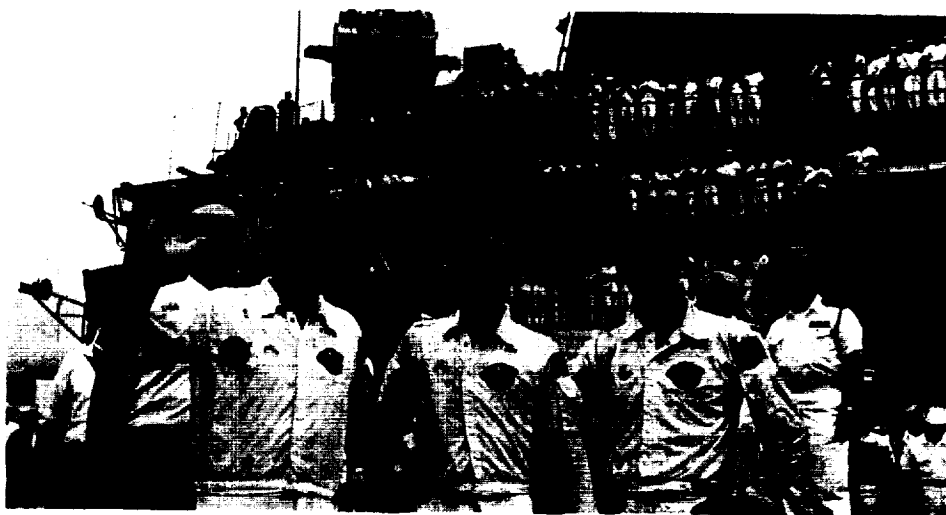

Apollo 7 commander Walter M. Schirra, Jr., waves from the U.S.S. *Essex* and crewmates Donn F. Eisele (center) and R. Walter Cunningham grin after splashdown and recovery October 22, 1968. Later the astronauts examine their spacecraft, also aboard the *Essex*.

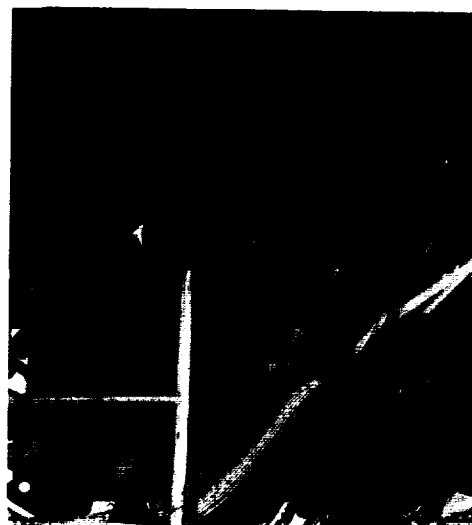

Hurricane Gladys, about 240 kilometers southwest of Tampa, Florida, was photographed by *Apollo 7* from an altitude of 180 kilometers, during the spacecraft's 91st revolution around the earth.

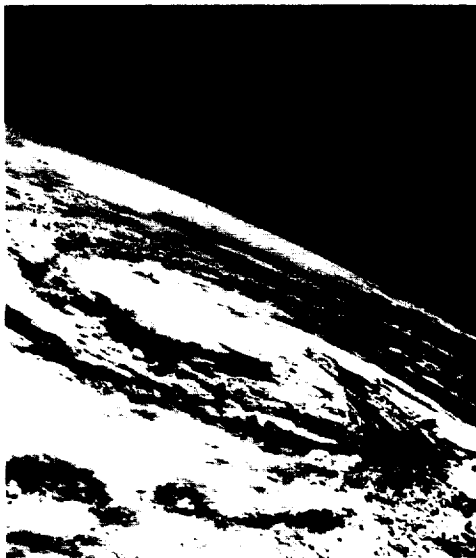

spacecraft splashed down about 13 kilometers from the recovery ship, the U.S.S. *Essex*, at 7:11 a.m. EDT October 22. Although the vehicle initially settled in an apex-down (“stable 2”) attitude, upright bags functioned normally and returned the CSM to an upright position in the water. Schirra, Eisele, and Cunningham were quickly picked up by a recovery helicopter and were safe aboard the recovery vessel less than an hour after splashdown.

1968
October

All primary *Apollo 7* mission objectives were met, as well as every detailed test objective (and three test objectives not originally planned). Engineering firsts from *Apollo 7*, aside from live television from space, included drinking water for the crew produced as a by-product of the fuel cells. Piloting and navigation accomplishments included an optical rendezvous, daylight platform realignment, and orbital determination via sextant tracking of another vehicle. All spacecraft systems performed satisfactorily. Minor anomalies were countered by backup systems or changes in procedures. With successful completion of the *Apollo 7* mission, which proved out the design of the Block II CSM (CSM 101), NASA and the nation had taken the first step on the pathway to the moon.

TWX, William C. Schneider to distr., “*Apollo 7* Mission, Mission Director’s 24-Hour Report,” Oct. 22, 1968; memos, George E. Mueller to Acting Administrator, “Manned Space Flight Weekly Report—October 14, 1968,” Oct. 14, 1968, and “Manned Space Flight Weekly Report—October 21, 1968,” Oct. 21, 1968.

Apollo Program Director Samuel C. Phillips ordered that the Saturn IB program be placed in a standby status pending any future requirements for Apollo or the Apollo Applications program. Phillips’ action signaled the shift in Apollo to the Saturn V vehicle, effective with AS-503.

16

TWX, Phillips to distr., “Saturn IB Program Planning,” Oct. 16, 1968.

- 1968**
October
17
- Dale D. Myers, Apollo CSM Manager at North American Rockwell, wrote ASPO Manager George Low on the policy question of contractor and subcontractor support of the current Apollo flight program and potential follow-on activities. Support for such activities, Myers said, "can be seriously jeopardized if we permit . . . experienced, specialized personnel and unique facilities to become irretrievably lost to the program." He emphasized in particular the case of Aeronca, Inc., of Middletown, Ohio, manufacturer of stainless steel honeycomb panels that formed the structure of the CSM heatshield. Without some sort of sustaining activity, manufacturing skills and capabilities at Aeronca—and numerous other subcontractors and vendors—would rapidly wither. Myers earnestly solicited Low's views on the subject of subcontractor capability retention. In Low's response, he indicated that immediate action was being initiated to establish capability retention for the three most critical sources, Aeronca, Beech, and Pratt and Whitney, and a plan of action was being prepared for others.
- Ltrs., Myers to Low, Oct. 17, 1968; Low to Myers, Nov. 15, 1968.
- 17**
- Two NASA investigation boards had reported that loss of attitude control caused the May 6 accident that destroyed lunar landing research vehicle No. 1, NASA announced (see May 6 and May 16). Helium in propellant tanks had been depleted earlier than normal, dropping pressure needed to force hydrogen peroxide propellant to the attitude-control lift rockets and thrusters. Warning to the pilot was too late for him to take necessary action for landing. The boards called for improvements in LLRV and LLTV design and operating practices and more stringent control over flying programs. No bad effects on the Apollo lunar landing program had been found and no changes were recommended for the LM.
- NASA Release 68-182, "LLRV Accident Report," Oct. 17, 1968.
- 18**
- David B. Pendley, Technical Assistant for Flight Safety at MSC, recommended to ASPO Manager George M. Low an official policy position for landings on land. Pendley stated that despite all efforts by the Center's Engineering and Development Directorate to develop a safe land-landing capability with the CSM, the goal could not be attained. The best course, he told Low, was to accept the risk inherent in the fact that a land landing could not be avoided in an early launch abort—accept the risk openly and frankly and to plan rescue operations on the premise of major structural damage to the spacecraft. "If we do not officially recognize the land landing hazard," Pendley said, "this will place us in an untenable position should an accident occur, and will further prejudice the safety of the crew by continuing a false feeling of security on the subject."
- Memo, Pendley to Low, "Land landings," Oct. 18, 1968.
- 19**
- NASA Apollo Program Director Samuel C. Phillips apprised Associate Administrator for Manned Space Flight George E. Mueller of recent

1968
October

program decisions and planning for extravehicular activities (EVA) on the first Apollo lunar landing mission. Primary objective on that first flight, Phillips said, had from the inception of the program been a safe manned landing and return. However, in light of current schedules, mission planning, and crew training activities, the agency must now commit itself to a definite scope for EVA activities on the first flight. After thorough review of the mission, a tentative EVA outline had been drawn up at the end of August and distributed to the Centers and Headquarters offices for comment. On September 11 the Manned Space Flight Management Council reviewed the proposed EVA scheme and criticisms and approved a formal EVA mission plan:

- The first mission would include a single EVA period of up to three hours. Training experience and simulations would form the basis for a decision on one- versus two-man EVAs during the period.
- The Apollo Lunar Surface Experiments Package and the Lunar Geology Investigation experiment would not be carried aboard the flight. Lunar soil samples would be collected. Also, other candidate experiments would be considered for inclusion on the flight.
- Television would be carried aboard the flight, both for operational and public information benefits.
- A paramount objective on the first landing would be to assess limitations and capabilities of the astronauts and their equipment in the lunar surface environment, to enhance the scientific return from the second and subsequent missions. (MSC was to structure detailed test objectives and experiments to satisfy this goal.)
- And MSC would recommend to Headquarters (including cost and schedule impacts) hardware changes that would lengthen the EVA time available for scientific investigations during subsequent flights.

Memo, Phillips to Mueller, "Extravehicular Activities for the First Lunar Landing Mission," Oct. 19, 1968.

MSC Director Robert R. Gilruth formally constituted an Operational Readiness Inspection Committee to inspect the Lunar Receiving Laboratory to demonstrate its suitability to accomplish its mission. John D. Hodge of MSC was appointed Chairman of the ORI and Peter J. Armitage, MSC, Executive Secretary. Other members were Aleck C. Bond, John W. Conlon, D. O. Coons, Joseph P. Kerwin, Paul H. Vavra, and Earle B. Young, all of MSC; E. Barton Geer, LaRC; A. G. Wedum, Ft. Detrick, Md.; and Donald U. Wise, NASA Hq.

Memo, Gilruth to distr., "Operational Readiness Inspection of the Lunar Receiving Laboratory," Oct. 21, 1968.

While the flight of *Apollo 7* was still in progress, ASPO Manager George M. Low ordered that CSM 101 be returned to Downey as quickly as possible at

1968
October

the end of the mission to begin postflight testing as quickly as possible. Therefore, no public affairs showing of the spacecraft could be permitted.

Memo, Low to Kenneth S. Kleinknecht, "Spacecraft 101 postflight activities," Oct. 21, 1968.

21

Associate Administrator for Manned Space Flight George E. Mueller summarized launch preparations for the near-term missions Apollo 8 and Apollo 9. Hurricane Gladys had interrupted work on the Apollo 8 spacecraft and launch vehicle and work was now about two days behind schedule. (Because winds from the storm did not exceed Apollo design values, however, Apollo 8 remained at Pad A and was not returned to the assembly building.) Checkout of LM-3 and CSM 104 for Apollo 9 were on schedule. The CSM had been stacked and would undergo combined systems tests shortly. Ascent and descent stages of the lander would be joined immediately after docking tests had been completed.

Memo, Mueller to Acting Administrator, "Manned Space Flight Weekly Report—October 21, 1968," Oct. 21, 1968.

PART III

Man Circles the Moon, the Eagle Lands, and Manned Lunar Exploration

October 23, 1968, through July 13, 1974

PART III

The Key Events

1968

December 8: Lunar landing training vehicle No. 1, with MSC test pilot Joe Algranti at the controls, crashed and burned at Ellington AFB, Tex. Algranti ejected safely.

December 21: *Apollo 8* was launched from KSC on a Saturn V booster. The spacecraft made 20 orbits around the moon on Christmas Eve and Christmas Day and returned to earth, landing in the Pacific Ocean December 27.

1969

February 3: NASA announced a 12-month forecast of manned space flight missions, *Apollo 9* through *Apollo 13*.

March 3: *Apollo 9* was launched from KSC and carried the LM for the first time on a manned flight. The LM separated and docked with the CSM during the flight and the first *Apollo* EVA was accomplished. The mission ended March 13 with an Atlantic Ocean splashdown.

March 24: NASA announced that *Apollo 10* would be a lunar orbit mission.

May 18: *Apollo 10* was launched from KSC on a nine-day mission. The spacecraft orbited the moon and the LM descended to an altitude of 15 kilometers over the planned site for the first lunar landing. Color TV was transmitted to earth. The CM landed safely in the Pacific May 26.

May 27: MSFC was authorized to proceed with development of a manned lunar roving vehicle.

June 17: A seven-day simulation of Lunar Receiving Laboratory activities was successfully completed.

July 16: *Apollo 11* was launched from KSC and on July 20 astronauts Neil A. Armstrong and Edwin E. Aldrin, Jr., became the first men to walk on the moon. The spacecraft returned to land in the Pacific July 24, and the space goal set by President Kennedy on May 25, 1961, was accomplished.

August 7: Conclusions were reached at MSC concerning modes for future lunar surface exploration.

November 14: *Apollo 12* was launched and landed on the moon 163 meters from the *Surveyor III* spacecraft. The two astronauts performed two EVAs on the lunar surface, retrieved samples and parts of *Surveyor III*, left the lunar surface after a stay of 31 hours 31 minutes, redocked with the CSM, and landed in the Pacific on November 24.

1970

January 5-8: Detailed reports on the *Apollo 11* sample analyses were presented at a Lunar Science Conference at MSC.

March 7: The President listed six specific objectives for the space program.

April 11: *Apollo 13* was launched on a lunar landing mission but 7 hours 55 minutes into the flight an explosion in an SM oxygen tank required an abort. The astronauts powered up the LM, powered down the CSM, and used the LM propellant for a free-return trajectory around the moon. They returned safely to earth, and landed in the mid-Pacific on April 17.

April 17: NASA Hq. established an *Apollo 13* Review Board to investigate the *Apollo 13* accident.

1971

- January 31:* *Apollo 14* was launched from KSC and the LM landed on the Fra Mauro area of the moon on February 5. Two EVAs were performed, the second using a mobile equipment transporter to permit a longer traverse. The LM lifted off from the moon February 6 and the CM splashed down in the Pacific on February 9.
- April 26:* Quarantine for crew members who would go to the moon on future Apollo flights was discontinued.
- July 26:* *Apollo 15* was launched, and on July 30 the LM landed in the Hadley-Apennine region of the moon. Three EVAs were completed with a total EVA time of 18 hours 35 minutes. The LM ascent stage liftoff on August 2 was the first televised, and the lunar roving vehicle was used for the first time. *Apollo 15's* CM landed in the Pacific on August 7.

1972

- April 16:* *Apollo 16* was launched from KSC and landed in the moon's Descartes region April 20. Three EVAs were completed, using the lunar roving vehicle for a total distance of 26.7 kilometers. The LM lifted off April 23 and docked with the CSM to transfer astronauts and samples. The CM returned to land in the Pacific April 27.
- December 7:* *Apollo 17*, the final manned lunar landing mission, was launched from KSC. The astronauts in the LM landed in the Taurus-Littrow region of the moon on December 11 and explored the area on the lunar roving vehicle during three EVAs with a total of about 22 hours. They lifted off December 14 and landed in the Pacific December 19.

1973

- January 22:* A tribute to the Apollo program from former President Johnson, who had died earlier in the day, was read at the National Space Club's "Salute to Apollo," held in Washington, D.C.
- November 2:* A stained glass Space Window with a two-centimeter *Apollo 11* lunar sample in its center was commissioned for the National Cathedral, Washington, D.C.

1974

- July 13:* President Nixon proclaimed July 16-24 United States Space Week in recognition of the fifth anniversary of *Apollo 11*.

PART III

Man Circles the Moon, the Eagle Lands, and Manned Lunar Exploration

October 23, 1968, through July 13, 1974

LeRoy E. Day, Apollo Test Director, NASA Hq., informed Apollo Program Director Samuel C. Phillips of two failures of LM propellant tanks during testing, a problem that might have significant program impact on LMs 6 and 7 and subsequent vehicles. The particular tanks in question were those manufactured by Allison Division of General Motors but reworked under separate contract by Airite Division of Sargent Industries. The two tanks, lightweight SWIP II models slated for LM-6 and subsequent vehicles, had suffered small cracks in the welds. So far, said Day, the weld process used in manufacture of the tanks was "highly suspect." Cryogenic proof-testing probably would be required to validate the tanks and to give confidence in the tank welds. Meantime, he said, the problem was receiving high-level attention both at Grumman and in Houston.

Memo, Day to Apollo Program Director, "LM Descent Propellant Tank Failures," Oct. 23, 1968.

1968
October
23

Howard D. Burns, Chief of the Saturn V Test Management Office at MSFC, sent to Apollo launch operations officials at KSC a list of requirements for retesting the Saturn V following a lightning strike on the vehicle while on the pad. These requirements were to be included in the next revision of the overall test and checkout requirements documents at KSC. (Burns' action came largely as a result of discussions at the AS-503 Crew Safety Review Board meeting at KSC on August 20-21, 1968.) Burns recommended that KSC prepare a contingency plan specifying various stage and launch vehicle test and checkout procedures that would satisfy MSFC's requirements. The most immediate assessment must be the overall safety of the launch vehicle. Electronic and electrical components headed the list of specific hardware systems to be assessed.

Ltr., Burns to KSC, Attn: A. G. Smith, "AS-503-10 Launch Vehicle Test and Retest Requirements Following a Lightning Strike on the Saturn V Launch Vehicle/LUT/MSS," Oct. 24, 1968, with encl., same subj.

24

1968

October

26

In a memorandum for the record, MSC's Apollo LM Program Manager C. H. Bolender reviewed results of the receiving inspection performed on LM-4 at KSC on October 21. Only 59 valid "crabs" were reported, 44 of them by Grumman's receiving personnel. None of the discrepancies noted involved major hardware damage or serious procedural faults. Significant progress had been made in reducing receiving discrepancies between LM-3 and LM-4. This improvement Bolender attributed to the addition of surveillance inspectors at Grumman and to the emphasis being placed on quality control by the resident ASPO personnel at Bethpage.

Memo for Record, Bolender, "Review of LM-4 Receiving Inspection at KSC," Oct. 26, 1968.

28

MSC Apollo Spacecraft Program Office Manager George M. Low deleted the requirement for a short static-firing of the Apollo 8 service module reaction control system on the pad before launch (the so-called "burp" firing). He took this move in line with a recommendation from NASA Apollo Program Director Samuel C. Phillips and in light of the nominal performance of the RCS during the *Apollo 7* flight. By thus eliminating the burp firings—and not allowing any contact of the system's hypergolic propellants—the spacecraft could be maintained in a loaded condition through the December and January launch windows and gain the maximum launch flexibility for the Apollo 8 flight. (Decisions not to static-fire the RCS systems on spacecraft following 103 had been made some time earlier.)

TWX, Phillips to Low, "Apollo 8 Pre-Launch Burp Firing," Oct. 25, 1968; ltr., Low to Phillips, Oct. 28, 1968.

31

NASA Apollo Program Director Samuel C. Phillips officially designated the AS-504 and AS-505 missions as Apollo 9 and Apollo 10.

TWX, Phillips, NASA Hq., to KSC, MSFC, and MSC, "Apollo Mission Designations," Oct. 31, 1968.

November

7

The Configuration Control Board had decided in favor of an informal crew log for each Apollo spacecraft, ASPO Manager George M. Low informed MSC Director of Flight Crew Operations Donald K. Slayton. The log would be an unofficial document kept by consulting pilots at the spacecraft contractor plants during checkout and test of the vehicles and by the flight crew support team at KSC. Although not intended to replace other, more formal procedures for recording hardware discrepancies, the log would contain such items as switching anomalies, meter bias, and what Low termed "bona fide 'ghosts'" which had no reasonable engineering explanation, as well as audible and visual "idiosyncracies" in spacecraft operation.

Memo, Low to Slayton, "Spacecraft crew log," Nov. 7, 1968.

8

ASPO Manager George M. Low asked Rocco A. Petrone, Launch Operations Director at KSC, to set up a special task team to review all paperwork and to inspect visually all hardware, to ensure proper spacecraft

deployment during the Apollo 8 flight. Apollo 8 contained a novel set of mechanical and electrical interfaces (CSM, LTA-B lunar module dummy, launch adapter, and Saturn V vehicle), Low observed. Furthermore, concern about these complex interfaces had increased because one of the adapter panels on *Apollo 7* had not opened properly. What Low—as well as MSC Director Robert R. Gilruth—desired foremost was to preclude repetition of another situation such as had occurred during the *Gemini IX* mission, when the shroud panels covering the Agena target vehicle had only partially deployed and had produced the “angry alligator” that forced cancellation of docking plans on that earlier flight.

Ltr., Low to Petrone, Nov. 8, 1968.

1968
November

The Apollo Crew Safety Review Board met to assess land landing of the CSM in the area of the launch site if a flight were aborted just before launch or during the initial phase of a flight. In general the Board was satisfied with overall planned recovery and medical operations. The only specific item to be acted on was some means of purging the interior of the spacecraft to expel any coolant or propellant fumes that might be trapped inside the cabin. The Board was also concerned about the likelihood of residual propellants trapped inside the vehicle even after abort sequence purging, a problem that MSC secured assistance from both the Ames and Lewis Research Centers to solve. At the Board's suggestion, MSC's Crew Systems Division also investigated the use of a helmet liner for the astronauts to prevent head injury upon impact. Finally, the Board recommended continued egress training with fully suited crews, including some night training.

Memo, David B. Pendley, MSC Flight Control Div., to ASPO Manager, “Land landing in the launch site area,” Nov. 18, 1968.

ASPO Manager Low asked Aaron Cohen, one of his staff assistants, to lead an investigation to determine detrimental effects of moisture on the strength of the bonded covering of the launch adapter structure. His action stemmed directly from a presentation the same day by James A. Chamberlin to the Structures Advisory Board explaining the adapter failure on *Apollo 6*. Moisture in the adapter not only raised the pressures generated by heating during the boost phase of the flight through the atmosphere, but it also weakened the structural bonding either directly or by hampering venting through the holes in the honeycomb material. Low asked Cohen to take precautions that no water be allowed to enter the adapter. All joints in the material should be sealed with a waterproof tape even before the count-down demonstration test and should remain on the vehicle throughout the flight, so that the adapter would absorb no moisture even if it rained during the final count before launch. On the other hand, the tape must then withstand boost phase heating and must not impair spacecraft separation and panel jettisoning. (North American Rockwell, in compliance with CCB, August 10, 1968, Master Change Record 7727, modified the SLA panels by drilling vent holes in the inner skin of the panels of all subsequent SLAs to

12

13

1968
November

allow release of moisture during ascent. These holes were to be kept sealed until immediately before launch to avoid collection of moisture in the honeycomb.)

Memo, Low to Cohen, "Verification of spacecraft/LM adapter," Nov. 13, 1968.

19

Martin L. Raines, MSC's Manager at the White Sands Test Facility, recommended to ASPO Manager George M. Low that he issue official direction to the two spacecraft contractors, North American Rockwell and Grumman, governing the phasedown of operations at the engine test site. Early action was needed, Raines said, for proper contractual action on the phasedown and for proper disposition of equipment and supplies. This action signaled the end of the long and difficult supportive development effort to prove out the Apollo spacecraft rocket engines for flight.

Memo, Raines to ASPO Manager, "WSTF Phasedown Plan," Nov. 19, 1968.

22

Howard W. Tindall, Jr., Chief of Apollo Data Priority Coordination within ASPO, reported an operational system problem aboard the LM. To give a returning Apollo crew an indication of time remaining to perform a landing maneuver or to abort, a light on the LM instrument panel would come on when about two minutes worth of propellants remained in the descent propellant system tanks with the descent engine running at 25-percent thrust. The present LM weight and descent trajectory were such that the light would always come on before touchdown. The only hitch, said Tindall, was that the signal was connected to the spacecraft master alarm. "Just at the most critical time in the most critical operation of a perfectly nominal lunar landing mission, the master alarm with all its lights, bells, and whistles will go off." Tindall related that some four or five years earlier, astronaut Pete Conrad had called the arrangement "completely unacceptable . . . but he was probably just an Ensign at the time and apparently no one paid any attention." If this "is not fixed," Tindall said, "I predict the first words uttered by the first astronaut to land on the moon will be 'Gee whiz, that master alarm certainly startled me.'" Tindall recommended either rerouting the signal wiring to bypass the alarm or cutting the signal wire and relying solely on the propellant gauges to assess flight time remaining.

Memo to distr., Tindall, "LM DPS low level light fixing," Nov. 22, 1968.

22

In a memorandum for the record, ASPO Manager George M. Low summarized results of November 19 and 22 meetings on procedures for astronaut training runs with the Apollo extravehicular mobility unit (EMU) under simulated space conditions. The runs would be in the two vacuum test chambers of the Center's Space Environment Simulation Laboratory. MSC Director Robert R. Gilruth had attended the meetings. Training runs were always to be preceded by a run also under altitude conditions and using a gas umbilical from the life support system of the facility itself. Although connected to the crewman, the facility umbilical would not be used as a gas supply under normal test conditions. For the final

1968

November

training run, the astronaut would wear a complete flight-configured EMU without any other link with the facility. Although several participants objected that training runs using the EMU alone ran greater risk than normal in chamber tests, the decision to conduct the exercises using the all-up flight configuration was reaffirmed.

Memo for Record, Low, "EMU activities in the SESL," Nov. 22, 1968.

NASA Associate Administrator for Manned Space Flight George E. Mueller reviewed for NASA Acting Administrator Thomas O. Paine the development of the Apollo service propulsion system (SPS) engine. (Earlier, Paine had asked whether the SPS engine had ever failed to fire during all of this developmental program.) Mueller reported that a review of the test history showed that no complete flight-configuration engine had ever failed to fire. In fact, during the entire development program (comprising some 3200 engine starts and more than 90 000 seconds of firing time) only four engines had failed to start. In all of these cases, the cause of the ignition failures could be traced to faulty ground support equipment or to inadequate or improper operational procedures. No engine failure could be attributed solely to the SPS engine itself. Mueller's response to Paine—with obvious overtones for the upcoming Apollo 8 circumlunar mission—bespoke a supreme confidence in the safety and reliability of the all-important main engine of the spacecraft.

22

Memo, Mueller to Acting Administrator, "Response to Question on Apollo Service Propulsion System Engine," Nov. 22, 1968.

The LM-11 midsection assembly collapsed in the assembly jig during the bulkhead prefabrication stage of construction at Grumman. The structure buckled when the bulkheads, which had just been prefabricated and drilled, were removed to permit deburring the drilled holes. Jig gates that were supposed to hold up the assembly were not in position, nor was the safety line properly installed. The structure was supported by hand. Damage to the skin of the structure was not severe, although a small radius bend was put in one of the upper skins.

27

Memo, Samuel A. Gentile, Bethpage RASPO Contracting Officer, to distr., "Report of Damage of LM-11 Midsection Assembly during Manufacturing Phase, this date," Nov. 27, 1968.

The need to flight-test manual control of the light LM ascent configuration had been discussed at the October 15 MSC Flight Program Review, MSC Director Robert R. Gilruth informed NASA Apollo Program Director Samuel C. Phillips. There was an implication that a control problem could exist for this configuration. Gilruth said he had stated that MSC should be able to establish manual control handling qualities of the LM through proper simulation and be confident about the adequacy of the control system.

27

Subsequently, Gilruth had reviewed the operating characteristics of the LM control system and the status of the simulation program related to manual

1968

November

control of the light ascent stage during docking. He said that the most demanding requirement for precision manual attitude control was the docking maneuver. Docking control had been simulated extensively at MSC, Grumman, and LaRC using functional representation of the control system and these simulations established the capability of docking the LM well within the specified docking criteria. In addition, other LM control tasks had been simulated at MSC and Grumman, and the LM was found to have satisfactory handling qualities for all manual control tasks.

Ltr., Gilruth to Phillips, "Manual Control of the Light Lunar Module Ascent Configuration," Nov. 27, 1968.

December

6

Several scientific experiments had been deferred from the first to the second lunar landing mission, Apollo Program Director Phillips informed the ASPO Manager at MSC: S-031, Lunar Passive Seismology; S-034, Lunar Tri-axis Magnetometer; S-035, Medium Energy Solar Wind; S-036, Suprathermal Ion Detection; S-058, Cold Cathode Ionization Gauge; and S-059, Lunar Geology Investigation. Substituted was a more conservative group that included Lunar Passive Seismology (S-031); a Laser Ranging Retroreflector (S078); and Solar Wind Composition (S-080). Also assigned to the first landing mission, included among operational tasks, were sampling activities and observations of lunar soil mechanics.

TWX, Phillips to Low, "Experiment Assignments to Lunar Missions," Dec. 6, 1968.

8

During a routine flight of lunar landing training vehicle (LLTV) No. 1, MSC test pilot Joseph S. Algranti was forced to eject from the craft when it became unstable and he could no longer control the vehicle. The LLTV crashed and burned. A flight readiness review at MSC on November 26 had found the LLTV ready for use in astronaut training, and 10 flight tests had been made before the accident. An investigating board headed by astronaut Walter M. Schirra, Jr., was set up to find the cause of the accident. And on January 8, 1969, NASA Acting Administrator Thomas O. Paine asked the review board that was established in May 1968 to restudy its findings on the May 6 crash of lunar landing research vehicle No. 1 (LLTV-1).

Memo, George E. Mueller, OMSF, NASA, to Acting Administrator, "Manned Space Flight Weekly Report—December 9, 1968," Dec. 9, 1968; NASA Release 69-5, "Review Board Reconvened," Jan. 8, 1969.

9

Launch preparations for Apollo 8, scheduled for flight December 21, were on schedule, the NASA Associate Administrator for Manned Space Flight reported. Recent significant steps included a leak and functional test of the service propulsion system on November 26, fuel servicing of the CM reaction control system and the SPS on the following day, hypergolic loading on November 30, and loading of the S-IC stage with RP-1 fuel on December 2. All testing of the Mission Control Center in Houston and the Manned Space Flight Network had also been completed; both support systems were ready for full operational support. Recovery briefings had been given to the flight crew and the final flight plan for Apollo 8 had been issued.

If all preparations continued to go smoothly, the final countdown for launch would begin on December 16.

1968
December

Memo, Mueller to Acting Administrator, "Manned Space Flight Weekly Report—December 9, 1968," Dec. 9, 1968.

The ASPO Manager asked Wilmot N. Hess, MSC Director of Science and Applications, to devise a crew fit and functional check of lunar handtools before the LM-5 crew training tests. Functional check of the handtools, as well as the Early Apollo Science Experiments Package (EASEP), had been agreed on at a November 26 review. Actual flight hardware would be used by the crewmen to verify operation of tools and experiments. Flight handtools—as well as the EASEP, if available—would also be subjected to thermal vacuum tests in the Space Environment Simulation Laboratory, preferably during LM-5 crew training in the facility.

14

Memo, George M. Low to Hess, "Lunar Handtools and EASEP (Early Apollo Science Experiments Package)," Dec. 14, 1968.

Final countdown for the launch of Apollo 8, the second manned Apollo mission, began on schedule at KSC. Significant launch preparation events included the "wet" countdown demonstration test on December 10, three days of flight simulations, an operational review, and launch site recovery exercises. Mission preparations were on schedule for launch on December 21. Launch preparations were also on schedule for the next two flights, Apollo 9 and 10.

15

Memo, George E. Mueller, NASA Associate Administrator for Manned Space Flight, to Acting Administrator, "Manned Space Flight Weekly Report—December 16, 1968," Dec. 16, 1968.

NASA Apollo Program Director Samuel C. Phillips asked ASPO Manager George M. Low for comments on potential uses for television aboard all Apollo spacecraft (both CMs and LMs). Although plans called for TV cameras in both spacecraft for the F and G missions, on the combined CSM-LM earth-orbital D mission only the LM was to contain a camera. Phillips asked Low to assess the feasibility and schedule impact of including a TV camera on the D-mission CSM as well (CM 104), thus employing television on all the remaining Apollo spacecraft. In particular, the Apollo Director sought Low's advice on the feasibility and usefulness of television transmissions for engineering, operations, scientific, and public information purposes. (See December 24.)

16

Ltr., Phillips to Low, "Apollo On-board TV," Dec. 16, 1968.

Apollo Program Director Phillips described to MSC Director Robert R. Gilruth two reviews of testing and checkout procedures, conducted by the Apollo Test Office and MSC's Crew Systems Division, at Hamilton Standard September 23-26 and at International Latex September 30-October 4. (The reviews were a follow-on to similar test and checkout reviews at North American Rockwell and at Grumman earlier in the year.) The review at

17

1968
December

“Ham-Standard,” manufacturer of the portable life support system, uncovered only two minor discrepancies, which the company immediately corrected. At International Latex, manufacturer of the Apollo spacesuit, however, the review teams found what Phillips termed a “disappointing situation despite extensive management direction by the Crew Systems Division.” The NASA review group made several recommendations to improve the situation:

- Improved management control of suit processing and checkout to afford higher confidence in configuration, inspection, and performance integrity.
- Stricter enforcement of the acceptance data package on each delivered suit.
- Compulsory contractor updating and enforcement of specifications to meet MSC spacesuit requirements.
- Improved and rigidly enforced discipline and cleanliness.

These problems, Phillips noted, had not impaired flight readiness of the spacesuit, “but it does explain the delivery problems we have been experiencing.”

Ltr., Phillips to Gilruth, Dec. 17, 1968.

17

Apollo Program Director Phillips asked ASPO Manager Low to hasten work on the study at North American to define reusability of systems aboard the CM. He asked Low for a review of the area in mid-February 1969 if sufficient data were available by then. Also, Phillips asked Low’s recommendations for an effectivity date on any recovery operations to increase reusability of either spacecraft systems or of the complete vehicle. (North American submitted Space Division Report No. 69-463, dated August 29, 1969, recommending preflight preservation treatment and postflight refurbishment that could be accomplished on CMs and its components to enhance reusability. Removal of heatshield access ports and flushing with fresh water on the recovery ship was the only recommendation implemented, because the others were not judged cost effective.)

Ltr., Phillips to Low, Dec. 17, 1968.

19

Crew briefings on flammability tests and fire extinguishing methods should be expanded, ASPO Manager Low recommended to MSC Director of Flight Operations Donald K. Slayton. Short briefings had been given to the crews of spacecraft 101 and 103, Low said, but these limited briefings should be expanded to ensure further a fire-safe spacecraft. At a minimum, he urged review of all flammability deviations inside the spacecraft, review of flammable crew storage items, review of significant fire testing films on propagation paths, and review of emergency procedures for extinguishing fires. The chief objective of this expanded program, said Low, was to

familiarize the crews with the flammable items in the cockpit that could not be replaced, with potential propagation paths, and with methods of extinguishing fires.

Memo, Low to Director of Flight Crew Operations, "Crew training program on fire safety,"
Dec. 19, 1968.

1968
December

The lunar closeup stereo camera on Apollo missions was not a separate scientific experiment, NASA Associate Administrator for Manned Space Flight wrote MSC Deputy Director George S. Trimble. An adjunct to the field geology experiment, the camera's stereoscopic photographs of fine details on the lunar surface would document individual material samples. Additional photography where no samples were taken would provide information on the range of surface textures near the landing site. Following deployment by the crew of emplaced experiments, the field geology investigation—and thus the stereo camera—had priority. Mueller stated that inclusion of the camera on all early Apollo landing missions was desirable, including the first. However, it was doubtful that the contractor could deliver the first flight article in time for that mission, although the camera could be ready for the second landing if granted waivers in documentation, reliability, and quality controls. Mueller affirmed his desire to grant these relaxations in the normally rigid Apollo hardware demands—to the extent that such waivers could be granted without jeopardizing crew safety or overall mission success. As an added benefit, the Associate Administrator said, "the experiment of giving a qualified contractor a relatively free hand in managing a development project within his particular field of competence should be instructive in the planning of future procurements of this type."

20

Ltr., Mueller to Trimble, Dec. 20, 1968.

Apollo 8 (AS-503) was launched from KSC Launch Complex 39, Pad A, at 7:51 a.m. EST Dec. 21 on a Saturn V booster. The spacecraft crew was made up of Frank Borman, James A. Lovell, Jr., and William A. Anders. *Apollo 8* was the first spacecraft to be launched by a Saturn V with a crew on board, and that crew became the first men to fly around the moon.

21-27

All launch and boost phases were normal and the spacecraft with the S-IVB stage was inserted into an earth-parking orbit of 190.6 by 183.2 kilometers above the earth. After post-insertion checkout of spacecraft systems, the S-IVB stage was reignited and burned 5 minutes 9 seconds to place the spacecraft and stage in a trajectory toward the moon—and the *Apollo 8* crew became the first men to leave the earth's gravitational field.

The spacecraft separated from the S-IVB 3 hours 20 minutes after launch and made two separation maneuvers using the SM's reaction control system. Eleven hours after liftoff, the first midcourse correction increased velocity by 26.4 kilometers per hour. The coast phase was devoted to navigation sightings, two television transmissions, and system checks. The second

1968
December

midcourse correction, about 61 hours into the flight, changed velocity by 1.5 kilometers per hour.

The 4-minute 15-second lunar-orbit-insertion maneuver was made 69 hours after launch, placing the spacecraft in an initial lunar orbit of 310.6 by 111.2 kilometers from the moon's surface—later circularized to 112.4 by 110.6 kilometers. During the lunar coast phase the crew made numerous landing-site and landmark sightings, took lunar photos, and prepared for the later maneuver to enter the trajectory back to the earth.

On the fourth day, Christmas Eve, communications were interrupted as *Apollo 8* passed behind the moon, and the astronauts became the first men to see the moon's far side. Later that day, during the evening hours in the United States, the crew read the first 10 verses of Genesis on television to earth and wished viewers "goodnight, good luck, a Merry Christmas and God bless all of you—all of you on the good earth."

Subsequently, *TV Guide* for May 10–16, 1969, claimed that one out of every four persons on earth—nearly 1 billion people in 64 countries—heard the astronauts' reading and greeting, either on radio or on TV; and delayed broadcasts that same day reached 30 additional countries.

On Christmas Day, while the spacecraft was completing its 10th revolution of the moon, the service propulsion system engine was fired for three

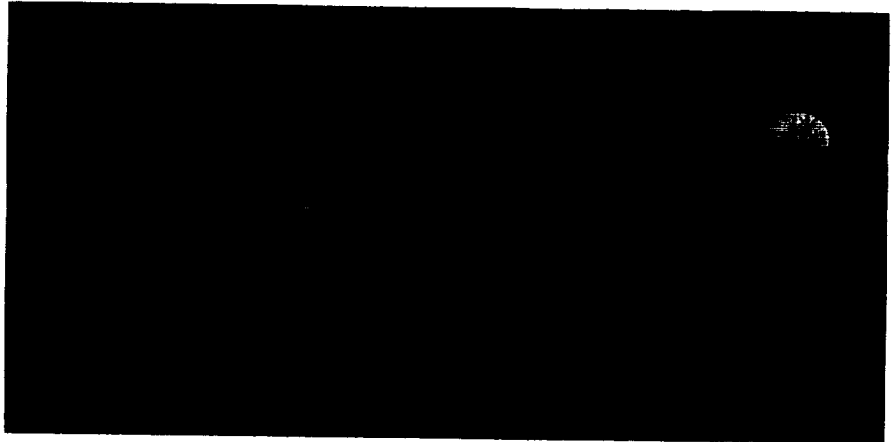

Earth-rise greeted the *Apollo 8* astronauts when they came from behind the moon after the lunar orbit insertion burn December 24, 1968. Lunar surface features in the foreground are near the eastern limb of the moon as seen from the earth. In the *Apollo 8* recovery scene December 27, the flotation collar has been attached and two life rafts inflated. Two of the three frogmen rest against the spacecraft while waiting for the recovery helicopter to arrive and pick up the astronauts.

1968
December

minutes 24 seconds, increasing the velocity by 3875 km per hr and propelling *Apollo 8* back toward the earth, after 20 hours 11 minutes in lunar orbit. More television was sent to earth on the way back and, on the sixth day, the crew prepared for reentry and the SM separated from the CM on schedule.

Parachute deployment and other reentry events were normal. The *Apollo 8* CM splashed down in the Pacific, apex down, at 10:51 a.m. EST, December 27—147 hours and 42 seconds after liftoff. As planned, helicopters and aircraft hovered over the spacecraft and pararescue personnel were not deployed until local sunrise, 50 minutes after splashdown. The crew was picked up and reached the recovery ship U.S.S. *Yorktown* at 12:20 p.m. EST. All mission objectives and detailed test objectives were achieved, as well as five that were not originally planned (see Appendix 5).

The crew was in excellent condition, and another major step toward the first lunar landing had been accomplished.

MSC, "Apollo 8 Mission Report," Feb. 1969, pp. 1-1, 1-2; NASA OMSF, "Apollo Program Flight Summary Report, Apollo Missions AS-201 through Apollo 8," Jan. 1969, pp. 32-35; *Astronautics and Aeronautics, 1968*, (NASA SP-4010, 1969), pp. 318-23.

ASPO Manager George M. Low apprised Program Director Samuel C. Phillips of MSC's plans for television cameras aboard remaining Apollo missions. With the exception of spacecraft 104 (scheduled for flight as Apollo 9), television cameras were to be flown in all CMs. Also, cameras would be included in *all* manned LMs (LM-3 through LM-14).

24

Ltr., Low to Phillips, "Television," Dec. 24, 1968.

C. H. Bolender, ASPO LM Manager at MSC, wrote Ralph H. Tripp, LM Program Manager at Grumman, regarding open spacecraft failure items. Although he acknowledged Grumman's recent progress in reducing the number of open failures, Bolender said that the approaching manned phase of the LM program dictated a fundamental change in the method of handling those open problems. Apollo required "zero open problems." Moreover, all failures must receive NASA approval of closeout before launch. Bolender called on Tripp to revamp his failure closeout procedures with several objectives: all closeout packages must contain sufficient documentation to permit NASA approval of the action; each package should be available as a reference for any future review of problem definition, analysis, and correction; and the contractor should further improve the discipline applied to technical resolution of open items and to the preparation of closeout packages. Bolender anticipated that Grumman's actions to meet these objectives would greatly reduce the number of open failure closeout disapprovals by NASA. But when a disagreement did exist, both parties must act quickly to resolve the issue. "Prompt attention to NASA disapprovals has been a problem," noted the LM Program Manager.

27

Ltr., Bolender to Tripp, Dec. 27, 1968.

1969
January
3

Mission preparation for Apollo 9 continued on schedule. Rollout of the space vehicle from the Vehicle Assembly Building, KSC, began. Mission Control Center simulations checkout, which began at MSC on December 20, 1968, was proceeding on schedule. Also, a series of thermal vacuum tests was completed, with the Apollo 9 crew using extravehicular mobility unit (EMU) flight equipment. Windup of these tests completed the required EMU testing for the Apollo 9 flight.

NASA OMSF, "Manned Space Flight Weekly Report—January 6, 1969."

14

MSFC announced that Arthur Rudolph, special assistant to the MSFC Director, would retire January 31. Rudolph had served as the manager of the Saturn V rocket program from August 1963 to May 1968. He was one of the more than 100 rocket experts who came to the United States from Germany in 1945. The MSC ASPO Manager, in a congratulatory letter said, "I will always consider Saturn V to be one of the outstanding achievements that occurred during my lifetime. Its sheer size is simply fantastic. But even more astounding was its performance in its first flights." Rudolph's work in bringing the nation's most powerful launch vehicle to flight status was rewarded when the first Saturn V lifted off from KSC and performed flawlessly on November 9, 1967, Rudolph's birthday.

MSFC Release 69-10, Jan. 14, 1969; ltr., George M. Low, MSC, to Arthur Rudolph, MSFC, Jan. 16, 1969; NASA OMSF, "Manned Space Flight Weekly Report—January 27, 1969."

15

The Apollo Program Director expressed concern to the Director of MSC over the lack of guidelines of sufficient scope and depth for the lunar missions that would be flown after the first lunar landing and before the proposed lunar exploration program tentatively scheduled to begin in 1973. He asked each of the manned space flight Centers to appoint a working group to define guidelines and to outline program objectives and content for the period of lunar exploration immediately following the first lunar landing. Areas requiring study were: scientific exploration, mission planning rationale, flight schedules and program impact, and vehicle product improvement.

Ltr., Samuel C. Phillips, NASA OMSF, to Robert R. Gilruth, MSC, Jan. 15, 1969.

15-17

The final flight program for Apollo 9 was verified; the emergency egress test with the prime and backup crew was conducted; and the software integration test between the lunar module and Mission Control Center, MSC, was completed on January 15. On January 16 the Saturn V/Mission Control Center-Houston integration testing was conducted. Additionally, a critical design review of the Launch Complex 39 slide wire system was conducted on January 17. Launch preparations for Apollo 9 continued to proceed on schedule.

NASA OMSF, "Manned Space Flight Weekly Report—January 21, 1969."

In response to a query, the ASPO Manager responded: "Insofar as the astronauts' 'call of nature' is handled, they urinate through a tube into a plastic bag. The bag is periodically emptied through an overboard dump nozzle. Although we have considered using an aircraft type relief tube that would dump overboard directly, we have not yet adopted this approach since an uncontrolled dump would most likely freeze the liquid in the tube or the dump nozzle. Defecation is handled through the use of a plastic bag, part of which fits over the hand like a glove. Although this method is primitive, it was found to work reasonably well, both in Gemini and in Apollo. A disinfectant pill is then placed in the bag and it is stowed in a special container in the spacecraft. The astronauts' diet, both before and during the flight, is such that the need to use this bag may only arise once or twice during the flight."

1969
January
16

Ltr., George M. Low, MSC, to Larry Megow, Houston, Tex., Jan. 16, 1969.

The Apollo Program Director requested that MSC present a Lunar Receiving Laboratory (LRL) review like that for design certification. The presentation would cover (1) landing and recovery procedures, (2) LRL operations, (3) release scheme for astronauts and samples, (4) sample processing and distribution plans, and (5) scientific investigations. The purpose would be to assess overall readiness following the first lunar landing in these five areas.

16

Ltr., Samuel C. Phillips, NASA OMSF, to Robert R. Gilruth, Director, MSC, "Lunar Receiving Laboratory Readiness Review," Jan. 16, 1969.

Checkout was on schedule for an Apollo 10 launch readiness date of May 17. On January 17 the backup crew participated in an altitude test run. The spacecraft docking test, using a simulated adapter, was completed January 20. All three fuel cells were being replaced because of suspected contamination in fuel cell No. 1 and the failure of fuel cell No. 2 to take any voltage load during the power-up for the manned altitude run.

17-20

NASA OMSF, "Manned Space Flight Weekly Report—January 27, 1969."

The Apollo 9 flight readiness test began on January 19 and was successfully completed January 22, in preparation for a February launch (see March 3-13). A one-day delay in the testing was caused by a loss of air conditioning for the RCA-110A computer. The hatch and side windows of the spacecraft were being modified to overcome the fogging effect experienced during the *Apollo 8* mission.

19-22

Ibid.

The CSM Flight Readiness Review Board convened at MSC. Martin L. Raines presented the Reliability and Quality Assurance assessment and pointed out the improvement in discrepancy reports between spacecraft 101,

24

1969

January

103, and 104 and concluded that 104 was better than 103 and ready to fly. George M. Low noted that the CSM Review had been outstanding.

Minutes of Meeting, CSM 104, Flight Readiness Review Board, approved by Robert R. Gilruth, Director, MSC, Feb. 7, 1969.

24

In an exchange of letters, the feasibility and compatibility of experiments covering contrast perception, color perception, and distance estimation on the moon were discussed. Incorporation of the three experiments in the lunar landing mission's detailed test objective "Lunar Environment Visibility" for Apollo 11 was recommended.

Ltrs., Samuel C. Phillips, NASA OMSF, to George M. Low, MSC, "Lunar Surface Life Sciences Observation Experiments T033, Contrast Perception on Moon; T034, Color Perception on Moon; T035, Distance Estimation on Moon," Jan. 24, 1969; Low to Phillips, Feb. 25, 1969.

Astronaut Stuart A. Roosa of the Apollo 9 support crew prepares to descend a rope following the first manned run down a slide wire in a cab from the 98-meter level of the mobile launcher at Kennedy Space Center in January 1968. Charles R. Billings of the KSC Safety Office walks away after his descent from the nine-man-capacity cab, and Arthur G. Porcher of the Design Engineering Office awaits his turn. The other six seats are occupied by weighted dummies.



The following tests were completed in preparation for the planned February Apollo 9 launch: all Mission Control Center data system integration tests, MSC preflight readiness test, KSC launch readiness test, and MSFC preflight test. In addition, recovery training exercises were conducted aboard the U.S.S. *Guadalcanal*, the prime recovery ship for Apollo 9.

NASA OMSF, "Manned Space Flight Weekly Report—February 3, 1969."

1969
January
24-29

MSC and North American Rockwell reached agreement on certification reviews for parachute packers in the Apollo program. The certification was effective for all parachute packers not previously certified, with upgrading of packers and recertification of present Apollo packers when required.

Ltrs., Dale D. Myers, North American Rockwell, to Kenneth S. Kleinknecht, MSC, Jan. 27, 1969; Kleinknecht to Myers, Nov. 8, 1968.

27

About 30 small aluminum brackets and fittings were replaced or reinforced in Apollo lunar modules to rule out the possibility of cracking from stress corrosion. Stress corrosion monitoring began in December 1967 when small cracks were discovered in LM landing gear struts. Nine fittings were replaced in LM-3, scheduled for the Apollo 9 mission, and six fittings were repaired in LM-4, scheduled for the Apollo 10 flight. About 25 fittings were being replaced on LM-5 and LM-6 and 8 fittings on each of these vehicles were being reinforced.

NASA News Release 69-24, "LM Fittings Changed," Jan. 31, 1969.

31

NASA Hq. asked Center directors for ideas for symbolic activities on the moon during the first landing to dramatize international agreements regarding exploration of the moon. Possible ideas were flying a U.N. flag with the U.S. flag on the moon; placing decal flags of the U.N. member nations on the LM descent stage; and leaving an appropriate information capsule at the landing site.

TWX, Samuel C. Phillips, NASA OMSF, to Robert R. Gilruth, MSC; Kurt H. Debus, KSC, and Wernher von Braun, MSFC, Jan. 31, 1969; ltr., Gilruth to Phillips, March 3, 1969.

31

During integrated testing of the Apollo spacecraft, a well-qualified test pilot accidentally threw two guarded switches marked "CM/SM Separation" instead of the intended adjacent switches marked "CSM/LM Final Sep" to separate the lunar module from the command and service modules. Had the error occurred in a lunar flight, the CM would have separated from the SM, with a high probability of leaving the crew stranded in lunar orbit. Studies of methods to preclude such an accident in actual flight led later to provisions for visual differences in switch covers.

Memos, Robert R. Frazer, MSC, to Resident Manager Apollo Spacecraft Program, "CSM 108 Erroneous Switch Closure," Jan. 31, 1969; David B. Pendley, MSC, to Manager, Apollo Spacecraft Program, "CM/SM separation switches," Feb. 17, 1969.

31

1969

February

3

In response to a query, a study indicated that, because of the temperature on the moon's surface, lunar samples would cool the LM cabin when placed in the rock box inside the cabin.

Memo, Wilmot N. Hess, MSC, to ASPO Manager, "Temperature of lunar samples," Feb. 3, 1969; ltr., George M. Low, MSC, to Samuel C. Phillips, NASA OMSF, Feb. 7, 1969.

3

NASA Hq. released a 12-month forecast of manned space flight missions, reflecting an assessment of launch schedules for planning purposes. Five flights were scheduled for the remainder of 1969:

- Apollo 9—February 28, SA-504, CSM 104, LM-3; manned orbital; up to 10 days' duration; Atlantic recovery.
- Apollo 10—May 17, SA-505, CSM 106, LM-4; manned lunar mission, Pacific recovery.
- Apollo 11—SA-506, CSM 107, LM-5; manned lunar mission; up to 11 days' duration; Pacific recovery.
- Apollo 12—SA-507, CSM 108, LM-6; manned lunar mission; up to 11 days; Pacific recovery.
- Apollo 13—SA-508, CSM 109, LM-7; manned lunar mission; up to 11 days' duration; Pacific recovery.

TWX, John D. Stevenson, NASA Hq., to addressees, "MSF Mission Operations Forecast for February 1969," Feb. 3, 1969.

5

The MSF Management Council, meeting at KSC, agreed that MSC would take the following actions for augmenting the capability of the Apollo system to accomplish a successful lunar landing mission and for planning further lunar exploration:

Capability Augmentation:

- Submit for Apollo Level I approval a plan for developing and procuring the A9L spacesuit.
- Submit a plan to the Apollo Program Director describing how the portable life support system's improvement program procurement would be done.
- Proceed with the 1/6-g special test equipment. The plan—including scope, schedule, and cost estimates for this simulator—would be submitted to Apollo Program Director by 1 March.
- Proceed with the engineering definition of software and hardware required to precision-land the LM at sites anywhere on the front surface of the moon.

Lunar Exploration:

- Submit a plan for the buildup of the cannibalized ALSEP, listing experiments to be included, the estimated cost, and delivery schedule.
- Submit a plan for the procurement of additional ALSEPs including proposed quantities, estimated costs, and experiments.

1969
February

- Proceed to define further a CSM lunar orbital science package and a lunar polar orbit mission science package, including instruments, costs, delivery schedule, and approach to CSM integration. Costs would include instruments and spacecraft integration.

- Proceed with the definition to increase the size of LM descent stage tanks and to improve the propellant pressurization system.

- Submit a plan for the procurement of a constant volume suit, including a description of any further development not under contract that MSC planned to add to any present contract by change order.

- Proceed with engineering change analysis of performance (including habitability) improvements to the CSM and LM.

Ltr., George E. Mueller, NASA OMSF, to Robert R. Gilruth, MSC, Feb. 14, 1969.

The permanently mounted spacecraft hoisting loop was inadequate for expected spacecraft loads and had failed on *Apollo 8*, ASPO Manager George M. Low informed Apollo Program Director Samuel C. Phillips. The auxiliary nylon loop installed by the recovery forces had adequate strength but its installation was not as well controlled as work on the spacecraft was generally. For these reasons, Low said, the astronauts would be required to leave the spacecraft before it was hoisted aboard the carrier. Low enclosed a memorandum from Don Arabian, "Hoisting spacecraft from sea," and minutes of a February 4 discussion at MSC on the subject.

Ltr., Low to Phillips, Feb. 8, 1969; memo, Donald D. Arabian to distr., "Hoisting spacecraft from sea," Feb. 6, 1969; Minutes of Discussion Concerning Hoisting Spacecraft from the Sea, W. F. Hoyler, Feb. 4, 1969.

The possibility of an unmanned LM landing was discussed at NASA Hq. The consensus was that such a landing would be a risky venture. Proposals had been made which included an unmanned LM landing as a prerequisite to a manned landing on the moon. However, the capability to land the LM unmanned did not exist and development of the capability would seriously delay the program.

NASA Routing Slip, R. L. Wagner, Bellcomm, to Samuel C. Phillips, NASA OMSF, Feb. 11, 1969; draft memo, George E. Mueller, OMSF, to NASA Acting Administrator, "Unmanned LM Landing," undated, unsigned.

Three members of the Interagency Committee on Back Contamination met at MSC to review Apollo operational plans and procedures. Some concern was expressed about the lack of a bacterial filter on the spacecraft postlanding system. However, the committee representatives indicated that the approach was reasonable in terms of the tradeoff on operational recovery problems. The full committee was scheduled to meet in March.

NASA OMSF, "Manned Space Flight Weekly Report—February 17, 1969."

George M. Low, MSC, told Maxime A. Faget, MSC, that he had recently learned the Apollo Operations Handbook (AOH) was prepared for the Flight Crew Operations Directorate by prime contractors without any

1969
February

formalized review by engineering elements of MSC. On several occasions, when the Engineering and Development (E&D) subsystems managers looked at a section of the handbook in connection with problem areas they found the handbook in error. Low proposed that E&D should (1) verify technical accuracy of the baseline issue of the handbook before its final issue for the F mission, (2) verify all changes in the AOH in a timely manner, and (3) verify any crew checklist changes made during the last 45 days before launch.

Memo, Low to Faget, "Review of Apollo Operations Handbook," Feb. 12, 1969.

- 14** Flammability tests of the Sony tape/voice recorder were made to determine if the recorder met crew-cabin use requirements. Testing was by electrical overloads of nichrome wire igniters in an atmosphere of 100 percent oxygen at 4.3 newtons per square centimeter (6.2 psia). Post-test evaluations indicated that flammability requirements had been met, since ignitions were self-extinguishing and only localized internal damage occurred.

Memo, Joseph N. Kotanchik, MSC, to Chief, Systems Engineering Div., MSC, "Flammability tests on Sony tape/voice recorder," Feb. 14, 1969.

- 17** MSC was urged to reconstitute the Crew Safety Review Board to determine if the following questions could be affirmatively answered concerning the LM, extravehicular activity, portable life support system, and emergency procedures. Were all likely failure modes or anomalies that could jeopardize the crew from entrance to mission systematically analyzed? Were proper and timely cues coupled with a safe egress, abort, or contingency capability prepared for use in each of these? Was there a plan for the timely solution of the known crew safety-related problems?

Ltr., Samuel C. Phillips, NASA OMSF, to George M. Low, MSC, Feb. 17, 1969.

- 22** The Apollo 9 countdown to launch began, with launch scheduled for liftoff February 28. The 10-day flight would mark the first manned earth orbital flight of the lunar module, the first Apollo spacewalk, and the first manned checkout, rendezvous, and docking operations of the complete Apollo spacecraft. The Apollo 9 mission would be open-ended, allowing the mission plan to progress from one step to the next on the basis of real-time success.

NASA OMSF, "Manned Space Flight Weekly Report—February 25, 1969."

- 27** Maxime A. Faget, MSC Director of Engineering and Development, said he believed the Preliminary Lunar Landing Phase Photographic Operations Plan was seriously deficient in meeting its stated objectives. "From the standpoint of public information and historical documentation, I'm terribly disappointed to find that although 560 feet [170 meters] of movie film has been set aside for lunar surface use none will be exposed with the intent of providing first-class visual appreciation of the astronaut's activity on the moon during this singularly historical event. Everyone's impression



Firing Room 2 at Kennedy Space Center during Countdown Demonstration Test—a dress rehearsal for Apollo 9. James Harrington, left, KSC Apollo 9 Test Supervisor, and Paul C. Donnelly, Apollo Launch Operations Manager, discuss procedures.

of this occasion will be marred and distorted by the fact that the greatest frame rate is 12 frames per second. One can argue that 'suitable' (although jerky) motion rendition is produced by 'double-framing.' Nevertheless, it is almost unbelievable that the culmination of a 20 billion dollar program is to be recorded in such a stingy manner and the low-quality public information and historical material is in keeping with an otherwise high-quality program." Faget also noted he felt that, from a historical standpoint, both the lunar module pilot and the commander should be photographed with the Hasselblad camera while on the surface.

Memo, Faget, MSC, to Chief, Mission Operations Br., "Comments on 'Preliminary Lunar Landing Phase Photographic Operations Plan,'" Feb. 27, 1969.

The Apollo Program Director expressed concern about the inability to obtain adequate data on the expenditure of energy by astronauts during lunar exploration. The problem was discussed with the medical and crew systems personnel. The consensus was that the only meaningful indicator of

1969
February

March
1

1969**March**

human energy expenditure which could be developed into an operational procedure in time for lunar landings would be measurement of carbon dioxide production. From a technical standpoint the most feasible means of doing this would be incorporating a carbon dioxide measurement system in the portable life support system. A study was initiated to determine how quickly a measurement system could be developed and to estimate the cost.

Ltrs., Samuel C. Phillips to Manager, Apollo Spacecraft Program Office, "Initiation of a Program for the Measurement of Carbon Dioxide Production during Lunar Exploration," March 1, 1969; George M. Low to Phillips, May 5, 1969.

3-13

Apollo 9 (AS-504), the first manned flight with the lunar module (LM-3), was launched from Pad A, Launch Complex 39, KSC, on a Saturn V launch vehicle at 11:00 a.m. EST March 3. Originally scheduled for a February 28 liftoff, the launch had been delayed to allow crew members James A. McDivitt, David R. Scott, and Russell L. Schweickart to recover from a mild virus respiratory illness. Following a normal launch phase, the S-IVB stage inserted the spacecraft into an orbit of 192.3 by 189.3 kilometers. After post-insertion checkout, CSM 104 separated from the S-IVB, was transposed, and docked with the LM. At 3:08 p.m. EST, the docked spacecraft were separated from the S-IVB, which was then placed on an earth-escape trajectory.

On March 4 the crew tracked landmarks, conducted pitch and roll yaw maneuvers, and increased the apogee by service propulsion system burns.

On March 5 McDivitt and Schweickart entered the LM through the docking tunnel, evaluated the LM systems, transmitted the first of two series of telecasts, and fired the LM descent propulsion system. They then returned to the CM.

McDivitt and Schweickart reentered the LM on March 6. After transmitting a second telecast, Schweickart performed a 37-minute extravehicular activity (EVA), walking between the LM and CSM hatches, maneuvering on handrails, taking photographs, and describing rain squalls over KSC.

On March 7, with McDivitt and Schweickart once more in the LM, Scott separated the CSM from the LM and fired the reaction control system thrusters to obtain a distance of 5.5 kilometers between the two spacecraft. McDivitt and Schweickart then performed a lunar-module active rendezvous. The LM successfully docked with the CSM after being up to 183.5 kilometers away from it during the six-and-one-half-hour separation. After McDivitt and Schweickart returned to the CSM, the LM ascent stage was jettisoned.

During the remainder of the mission, the crew tracked *Pegasus III*, NASA's meteoroid detection satellite that had been launched July 30, 1965; took multispectral photos of the earth; exercised the spacecraft systems; and prepared for reentry.

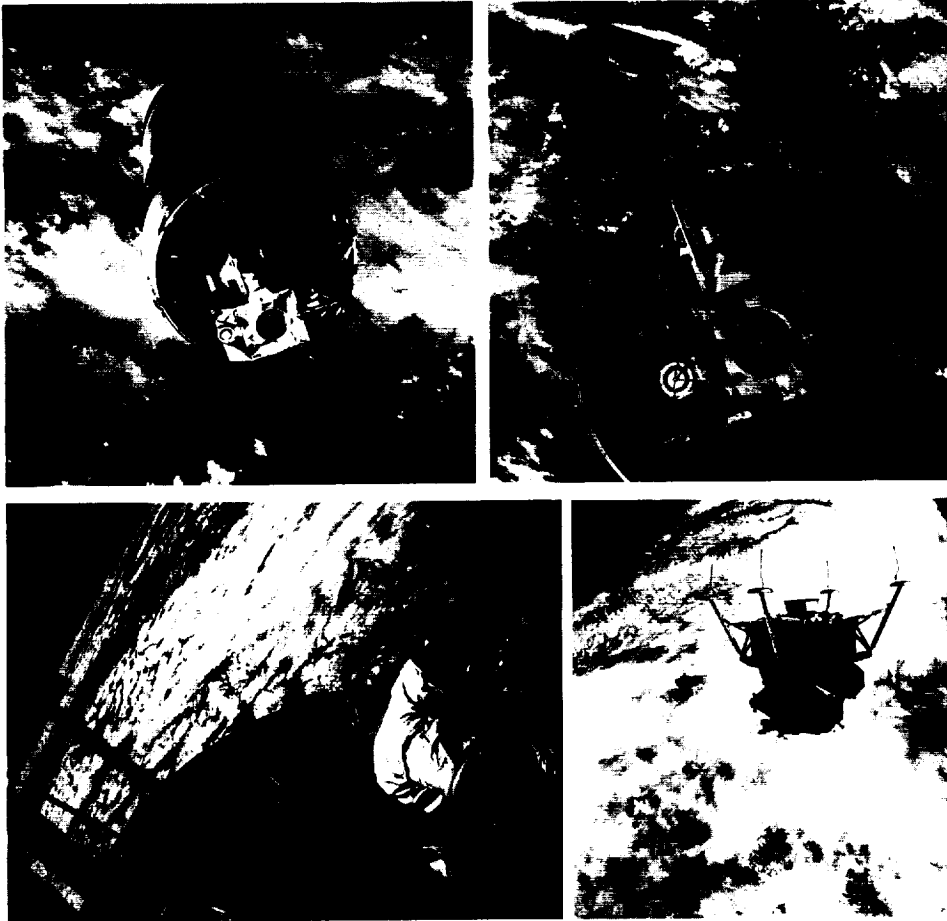

At top, LM-3 is still attached to the S-IVB stage after launch on the *Apollo 9* mission March 3, 1969. The CM has separated and turned around, moving in toward docking with the LM and separation. On the fourth day of the earth-orbital mission, CM pilot David R. Scott stood in the open hatch of the CM, photographed by LM pilot Russell L. Schweickart from the "front porch" of the LM, designated *Spider* during the flight. At the bottom right, *Spider* flies in lunar landing configuration, upside down to earth, with lunar surface probes extending from deployed foot pads. *Apollo 9* commander James A. McDivitt flies with Schweickart in the LM, photographed by Scott from the CM *Gumdrop*.

The *Apollo 9* CM splashed down in the Atlantic 290 kilometers east of the Bahamas at 12:01 p.m. EST. The crew was picked up by helicopter and flown to the recovery ship U.S.S. *Guadalcanal* within one hour after splashdown. Primary objectives of the flight were successfully accomplished. (Objectives of all Apollo flights are listed in Appendix 5.)

MSC, "Apollo 9 (AS-504) Flight Summary," undated; MSC, "Apollo 9 Mission Report" (MSC-PA-R-69-2), May 1969; NASA OMSF, "Manned Space Flight Weekly Report," March 4, 17, 1969.

1969
March

1969

March

5

President Nixon, at a White House ceremony, announced the nomination of Acting Administrator Thomas O. Paine to be the NASA Administrator.

Office of the Federal Register, National Archives and Records Service, *Weekly Compilation of Presidential Documents*, March 10, 1969, pp. 369-71.

6

NASA Associate Administrator for Manned Space Flight George E. Mueller, wrote MSC Director Robert R. Gilruth of his concern about Apollo software. "Software as I mean it to be understood in this letter includes computer programs, mission profiles and procedures (training). As I recall, the Apollo project started with a legacy of warnings from other programs about the rigors and pitfalls of software development. . . . I believe we are giving far more management attention to hardware changes than to software changes of similar impact." He questioned "whether some of these changes make the system better or safer when the disruptive effects of change are also considered. . . . We are making too many discretionary software changes. These are costing money and effort which could better be used elsewhere. . . ."

Gilruth replied March 11: "I cannot agree with your contention that we are not controlling software with the same rigor and management attention that we are devoting to hardware changes. Our Apollo Spacecraft Program Office has organized a number of Configuration Control Boards at MSC. These include George Low's Apollo Spacecraft Configuration Control Board, Max Faget's Board for Government Furnished Equipment, Chris Kraft's Software Configuration Control Board, and Deke Slayton's Procedures Change Control Board. . . . Hardware changes . . . are directly under George Low's control. All computer program changes, both on board and on the ground, are controlled by Chris Kraft's Board. Changes to the Apollo Operations Handbook, flight crew procedures, crew checklists, trainers and simulators are controlled by Slayton. Changes in software or crew procedures that involve changes in schedule must additionally be approved by George Low's Board. The system I described is working well and, according to Sam Phillips, has resulted in a more disciplined change control than anywhere else in the Apollo Program. . . . We are not making discretionary software changes. We are only making those changes which our managers deem to be necessary in their effort to carry out the Apollo Program in the most effective manner."

Ltrs., Mueller to Gilruth, March 6, 1969; Gilruth to Mueller, March 11, 1969.

7

In a report to the Administrator, the Associate Administrator for Manned Space Flight summed up the feeling of accomplishment as well as the problem of the space program: "The phenomenal precision and practically flawless performance of the Apollo 9 lunar module descent and ascent engines on March 7 were major milestones in the progress toward our first manned landing on the moon, and tributes to the intensive contractor and government effort that brought these two complex systems to the point of safe and reliable manned space flight. The inevitable developmental

problems that plagued the LM propulsion system were recurring items in our management reporting, and the fact that essentially all major test objectives were met during last Friday's flight operations is an outstanding achievement. The earth orbital simulations of the lunar descent, ascent, rendezvous, and docking maneuvers, taking Astronauts McDivitt and Schweickart 114 miles [183.4 km] away from the CSM piloted by Dave Scott and safely back, were a measure of the skill of the Apollo 9 crew and the quality of the hardware they were flying."

1969

March

NASA OMSF, "Manned Space Flight Weekly Report—March 10, 1969."

A radiation survey of CSM 107 was planned to determine if the radiation produced by onboard sources would be of a sufficient level to impair the effectiveness of proposed experiments to measure the natural radiation emitted from the lunar surface. The survey would be conducted at KSC by personnel from the Goddard Space Flight Center.

7

Ltr., Kenneth S. Kleinknecht, MSC, to Rocco A. Petrone, KSC, "Background radiation survey of Apollo CSM," March 3, 1969.

A Flight Readiness Review Board convened at MSC to determine the readiness of Lunar Landing Training Vehicle No. 2 and the Flight Crew Operation Directorate for resuming flight test operations. During the briefing and discussion the board agreed that the operation test team was operationally ready. However, a release for resuming flight test operations was withheld until certain open items were resolved. The board reconvened on March 31 and after examination of the open items, agreed that flight testing of LLTV No. 2 should be resumed as soon as possible.

10 and 3

Minutes, Lunar Landing Training Vehicle Number Two (LLTV No. 2) Flight Readiness Review Board (FRRB), April 1, 1969.

Apollo 10 was transferred to Pad B, Launch Complex 39, at KSC—for first operational use of Pad B. Meanwhile, a revised work schedule providing for a Flight Readiness Test on April 9 and launch readiness on May 18 was being prepared for Apollo 10.

11

NASA OMSF, "Manned Space Flight Weekly Report—March 17, 1969."

The additional direct cost to the Apollo research and development program from the January 27, 1967, Apollo 204 fire was estimated at \$410 million, principally for spacecraft modifications, NASA Associate Administrator for Manned Space Flight George E. Mueller testified in congressional hearings. The accident delayed the first manned flight of the spacecraft by about 18 months. "During this period, however, there occurred a successful unmanned test of the Lunar Module and two unmanned tests of the Saturn V vehicle."

11

House Committee on Science and Astronautics, Subcommittee on Manned Space Flight, *1970 NASA Authorization: Hearings*, 91st Cong., 1st sess., pt. 2, Feb. 28, March 6, 7, 8, 11, 12, 14, and 25, 1969, pp. 183-85.

1969
March
12

George M. Low discussed the status of a fire detection system for Apollo in a memorandum to Martin L. Raines, reminding him that such a system had been under consideration since the accident in January 1967. Low said: "Yesterday, Dr. [Maxime A.] Faget, you, and I participated in a meeting to review the current status of a flight fire detection system. It became quite clear that our state of knowledge about the physics and chemistry of fire in zero gravity is insufficient to permit the design and development of a flightworthy fire detection system at this time. For this reason, we agreed that we would not be able to incorporate a fire detection system in any of the Apollo spacecraft. We also agreed that it would be most worthwhile to continue the development of a detection system for future spacecraft." (See also entries of March 27 and September 28, 1967, and April 17, 1968.)

Memo, Low to Raines, "Fire detection system for Apollo," March 12, 1969.

13

MSC requested that Apollo Program Directive No. 41 delivery dates for the LM be changed as follows: LM-6 from March 1 to March 26, LM-7 from April 16 to May 15, LM-8 from May 31 to July 15, and LMs 9 through 14 two months apart. The rescheduling was to permit incorporation of the redesigned ascent-stage fuel-tank torus ring, installation and testing of the liquid-cooled suit loop, replacement of the descent-stage tanks, and incorporation of structural fitting changes to prevent stress corrosion.

TWX, George M. Low to NASA Hq., Attn: S. C. Phillips, March 13, 1969.

14

MSC Director Robert R. Gilruth forwarded plans for the MSC Lunar Gravity Simulation device to Apollo Program Director Samuel C. Phillips. He informed Phillips that "we have moved out on the design and fabrication of the inclined plane $\frac{1}{6}$ g simulator and our schedule shows that it will be completed and ready for checkout by May 1, 1969 [see February 5]. The vertical system approach is somewhat more sophisticated and our scheduled completion is February 1, 1970." Phillips replied March 28 that he was pleased to read that the simulator program was progressing so rapidly and "I feel very strongly that this device will greatly contribute to our capability to create useful lunar exploration missions."

Ltrs., George E. Mueller to Gilruth, Feb. 14, 1969; Gilruth to Phillips, March 14, 1969; Phillips to Gilruth, March 28, 1969.

20

ASPO Manager George Low wrote NASA Hq.—referring to a briefing of George Low at Downey on October 25, 1968—that "MSC has reviewed the possibility of deleting the CSM boost protective cover. We have concluded that deletion . . . would require the following spacecraft modifications: a. A new thermal coating would have to be developed to withstand the boost environment. b. Protective covers would have to be developed for the windows, EVA handholds, vent lines, etc. . . . We have further concluded that a resulting overall weight reduction is questionable, and . . . have

therefore decided that the cost of this change could not be justified and that the boost protective cover should be retained.”

1969

March

Ltr., Low to S. C. Phillips, “Deletion of the boost protective cover,” March 20, 1969.

NASA announced that Apollo 10, scheduled for launch May 18, would be a lunar orbit mission during which two astronauts would descend to within 15 240 meters of the moon’s surface. The decision followed reviews of technical and operational data from the *Apollo 9* earth-orbit mission. The prime crew would be astronauts Thomas P. Stafford, spacecraft commander; John W. Young, command module pilot; and Eugene A. Cernan, lunar module pilot. Backup crew members were L. Gordon Cooper, Jr., Donn F. Eisele, and Edgar D. Mitchell. With the exception of the actual landing, the mission plan was the same as for the lunar landing mission. Stafford and Cernan were to enter the LM, separate from the CSM, descend twice to within 16 kilometers of one of the preselected landing sites, and then rendezvous and dock with the CSM. Because of propellant limitations in the ascent stage, landing and subsequent liftoff from the moon would be impossible.

24

NASA News Release No: 69-46, “Apollo 10 Mission Scheduled,” March 24, 1969.

The first flight-model ALSEP arrived at KSC, where it would undergo software integration tests and be prepared for installation in the LM.

25

NASA OMSF, “Manned Space Flight Weekly Report—April 1, 1969.”

Following a report by the *Apollo 9* astronauts that they were thrown forward in their seats and had to grab their arm rests for support during the S-IC/S-II stage separation, an evaluation working group were studying the problem. Preliminary results indicated that the separation transients were a dynamic characteristic of the Saturn V vehicle; that the measured accelerations were within predicted range and below design limits; and that the separation sequences were normal. Conclusions were that similar separation dynamics could be anticipated on future Saturn V flights.

28

Memo, J. P. Lindberg, MSFC, to Addressees, “Special Bulletin on S-IC/S-II Stage Separation, AS-504,” March 28, 1969.

ASPO requested a plan for flight crew tests of sleeping pills and other drugs. The plan was to include number of tests to be performed by each crew member; time of the test with respect to the last sleep period; amount and kind of food and drink taken during a specified time before the test; general physical activity by the crew before taking a drug; and, for comparison purpose, any available statistical information on the effect of these pills after being taken.

April

3

Memo, George M. Low, ASPO Manager, to Charles A. Berry, Medical Research and Operations Directorate, MSC, “Use of sleeping pills,” April 3, 1969.

1969

April

5

ASPO Manager George Low, commented on control of Apollo spacecraft weight. Following the January 1967 spacecraft fire at Cape Kennedy, there had been substantial initial weight growth in the CSM. This was attributed to such items as the new CSM hatch, the flammability changes, and the additional flight safety changes. In mid-1967 the CSM weight stabilized and from then on showed a downward trend. The LM weight stabilized in mid-1968 and since that time had remained fairly constant. Conclusions were that the program redefinition had caused a larger weight increase than expected, but that once the weight control system became fully effective, it was possible to maintain a weight that was essentially constant. Low told Caldwell C. Johnson, Jr., of the MSC Spacecraft Design Division that the weight control was in part due to Johnson's strong inputs in early 1968. Johnson responded, "Your control of Apollo weight growth has destroyed my reputation as a weight forecaster—but I'm rather glad."

Ltrs., Low to Apollo Program Director Samuel C. Phillips, April 5, 1969; Phillips to Low, May 5, 1969; memos, Low to Johnson, "Apollo weight growth," April 5, 1969; Johnson to Low, "Apollo weight growth," April 8, 1969.

7-11

Work on Apollo 10 continued on schedule for a May 18 launch readiness date. The flight readiness test began on April 7 and was completed on April 10. A lunar module mission-simulation run was completed on April 10, and a crew compartment fit and function test on April 11. Mission control simulations were proceeding on schedule without major problems. The Apollo 10 preflight readiness review was held at MSC on April 11.

NASA OMSF, "Manned Space Flight Weekly Report—April 14, 1969."

12

ASPO Manager George Low informed MSC Director of Science and Applications Wilmot N. Hess that he had signed paperwork increasing the weight allowance for the Apollo scientific payload from 136 to 156.4 kilograms. Low said he was able to do this for the LM-6 (Apollo 12) mission because of the favorable LM weight picture. He stated, however, "I believe that we should understand that this increase in weight allowance does not alter our basic agreement to provide for a scientific payload of 300 pounds [136 kilograms]. In the event that future difficulties with the Lunar Module require additional weight growth in the basic spacecraft system, we will have to once again reduce the scientific payload to 300 pounds [136 kilograms]. . . . I wanted to be sure that we agreed in advance that the added 45 pounds [20.4 kilograms] of scientific payload allowance would be the first weight to be deleted. . . ." Hess concurred with the memorandum.

Memo, Manager, ASPO, to Hess, "Increased weight allowance for Apollo scientific payload," April 12, 1969.

14-21

Twenty-two astronauts trained in the MSC Flight Acceleration Facility during the week, for lunar reentry. Closed-loop simulation permitted the crews to control the centrifuge during the lunar reentry deceleration

profiles. Each astronaut flew four different reentry angles, which imposed acceleration loads of from 4.57 to 9.3 g.

1969

April

NASA OMSF, "Manned Space Flight Weekly Activity Report—April 21, 1969."

ASPO announced changes in launch readiness dates for the Apollo 12 and Apollo 13 missions. Apollo 12 was moved up from September 18 to September 13, 1969; and Apollo 13 was moved up from December 1 to November 10.

18

Memo, George M. Low to distr., "Apollo launch readiness dates for Apollo 12 and 13 changes," April 18, 1969.

The Director of Apollo Test in the NASA Hq. Apollo Program Office, LeRoy E. Day, was detailed to head the MSF Space Shuttle Task Group. The group would provide NASA with material for a report on the Space Shuttle to the President's Space Task Group.

21

Memo, George E. Mueller, NASA OMSF, to distr., "Special Assignment of Mr. LeRoy E. Day, Director of Apollo Test," April 21, 1969.

Discovery of six new mascons (mass concentrations of dense material) beneath the moon's surface by William L. Sjogren, Paul M. Muller, and Peter Gottlieb of Jet Propulsion Laboratory was announced. The first six mascons had been discovered in 1968 by Sjogren and Muller. Each mascon was found to be centered below a ringed sea, or an ancient, obliterated circular sea on the side of the moon's surface facing the earth. Noticeable acceleration variations were seen as moon-orbiting spacecraft flew over the mascons. Information was not available concerning possible mascons on the far side of the moon, since orbiting spacecraft could not be tracked while the moon blocked them from the view of earth antennas.

25

NASA News Release 69-61, "New Lunar Mascons Discovered," April 25, 1969.

In an exchange of correspondence, Samuel C. Phillips, NASA OMSF, and ASPO Manager George Low, MSC, discussed the possibility of carrying an aseptic sampler and a closeup stereo camera on the Apollo 11 flight. They decided the flight would carry the camera as an additional source of data; Apollo 11 crewmen would use it on targets of opportunity during lunar surface exploration. Because of the unrealistic schedule that would be required to certify the flight worthiness of the aseptic sampler, however, they decided not to fly it on Apollo 11.

25-26

TWX, Phillips to Low, "Assignment of Priority for Aseptic Sampler and Close-up Camera for Apollo G-1 Mission," April 25, 1969; ltr., Low to Phillips, April 26, 1969.

A power outage, required to permit maintenance work at the KSC Launch Control Center, was relayed to the pneumatic controls of the S-IC stage of the Apollo 10 launch vehicle, causing the prevalves to open and allowing 5280 liters of RP-1 fuel to drain from the vehicle. This, in turn, produced negative pressure in the RP-1 tank, which displaced the upper bulkhead.

28

- 1969**
April
- After repressurization, the bulkhead apparently returned to its normal shape. An effort was under way to determine the nature of the damage to the bulkhead and the effect on the May 18 Apollo 10 launch readiness date.
- NASA OMSF, "Manned Space Flight Weekly Report—April 28, 1969"; "Manned Space Flight Weekly Report—May 5, 1969."
- 29**
- The NASA Associate Administrator for Manned Space Flight concurred in a recommendation to carry an erectable antenna on the Apollo 11 mission. However, it would be deployed only if required to obtain satisfactory television, voice, telemetry, and biomedical data simultaneously from the lunar surface.
- Ltr., George H. Hage, NASA OMSF, to George M. Low, MSC, "LM Steerable Antenna Versus Erectable Antenna," April 29, 1969.
- May**
2
- A temporary fix to provide for an S-II-stage early center engine cutoff was made for Apollo 10 and 11. Purpose was to eliminate oscillations of the center engine and sympathetic structures. (See March 28, 1969, entry.) Meanwhile, plans were being made to incorporate a permanent fix into Apollo 12 and subsequent vehicles to eliminate the oscillations.
- TWX, Samuel C. Phillips, NASA OMSF, to Lee B. James, MSFC, Roderick O. Middleton, KSC, and George M. Low, MSC, "Permanent Fix for S-II Stage Oscillations," May 2, 1969.
- 5**
- ASPO reported a recent manned-test abort of the portable life support system had been caused by a nonfunctional lithium hydroxide canister. Quality control procedures were in existence and if properly implemented would have precluded the abort incident. To prevent similar incidents from occurring, all manned-test and flight equipment would be accompanied by complete documentation, would be visually inspected, and would be certified by quality assurance personnel before use.
- Memo, ASPO Manager to Acting Manager for Flight Safety, MSC, "Incident involving an out-of-configuration LiOH canister in an MSC manned altitude test," May 5, 1969.
- 5**
- MSC asked North American Rockwell to propose a design modification in the CM to add a cold storage compartment for fresh and frozen foods. If the frozen food study appeared promising, then the addition of a small oven or heater, similar in concept to that used by the Air Force on long flights, would also be required.
- Ltr., Kenneth S. Kleinknecht, MSC, to George W. Jeffs, North American Rockwell, May 5, 1969.
- 7-8**
- The fifth and final drop test of LM-2 was made on May 7. The first four drop tests had been made to establish the proper functioning of all LM systems after a lunar landing. The fifth test was made to qualify the functioning of the pyrotechnics after landing. On May 8, the final test, physically separating the ascent stage, was conducted.
- NASA OMSF, "Manned Space Flight Weekly Report—May 12, 1969."

1969

May

Apollo Program Director Samuel C. Phillips suggested to MSC Director Robert R. Gilruth that a meeting be held at MSC during the period of the Apollo 10 return flight to earth to review the status of experiment support facilities and the overall plans for science support operations during lunar missions and over an extended period of time. Phillips pointed out that the results from the Early Apollo Scientific Experiments Package, the Apollo Lunar Surface Experiments Packages, the Lunar Geology Experiment, and the analyses of the returned lunar samples would be of inestimable scientific value. However, NASA in the dissemination of the scientific results would require a science operations and data management plan which would spell out the operational, support, management, data-handling, and science relationships.

Ltr., Phillips to Gilruth, May 8, 1969.

The Apollo Back Contamination Documentation and Configuration Control Office was established at MSC to provide a documentation program for any possible contamination from the moon. The program was required by June 15, to meet deadlines for the launch of Apollo 11.

Memo, Richard S. Johnston, MSC, to distr., "Apollo Back Contamination Documentation Control Office," May 8, 1969.

NASA Hq. informed MSC that, for planning purposes and Change Control Board action, the following science sequence was being recommended for the Apollo 12 mission: (1) contingency sample; (2) ALSEP deployment; and (3) field geology investigations. The message said, "It is important that ALSEP be deployed in the first EVA (extravehicular activity). Then the entire second EVA could be devoted to Field Geology Investigations."

TWX, Samuel C. Phillips, NASA OMSF, to George M. Low and Wilmot N. Hess, MSC, "Mission H-1 Recommended Science Sequence," May 9, 1969.

MSC forwarded a plan for the Apollo 15 Lunar Surface Science Project to NASA Hq. The plan provided for replacement of the ALSEP Array A-2 central station and lunar geological equipment, along with rework of the Passive Seismic Experiment. Total cost of the project was estimated at \$6.7 million excluding the cost of surveying instrument and instrument staff. With a May 15 go-ahead, delivery could be made by one year from that date. Apollo Program Director Samuel C. Phillips in a message to MSC Director Robert R. Gilruth approved the plan, saying that a June 1, 1970, delivery of the array would be acceptable and requesting procurement action leading to a definitive Bendix contract be submitted by June 20, 1969.

Ltr., Gilruth to George E. Mueller, NASA Hq., "Apollo 15 Lunar Surface Science," May 9, 1969; TWX, Phillips to Gilruth, June 12, 1969.

1969

May

12

Because the first flight of the ALSEP was scheduled on Apollo 12, NASA Hq. asked MSFC to provide for installation at KSC of the prelaunch cooling system for the ALSEP radioisotopic thermoelectric generator (RTG) on instrument units 507 through 510.

TWX, Samuel C. Phillips, NASA Hq., to MSFC, May 12, 1969.

13

NASA policy on release of manned space flight communications was outlined. The policy was to release all air-to-ground conversations in real time. However, if circumstances arose in which crew or mission director requested a private conversation, the public information officer responsible for the mission commentary would be notified and would monitor the conversation with the mission director. A summary would be released at the discretion of the Office of Public Affairs. Tapes of the air-to-ground private conversations would not be released.

Memo, T. O. Paine, NASA Administrator, to S. C. Phillips, NASA OMSF, May 13, 1969; Itr., G. E. Mueller, OMSF, to R. R. Gilruth, MSC, May 15, 1969.

18-26

Apollo 10 (AS-505)—with crew members Thomas P. Stafford, Eugene A. Cernan, and John W. Young aboard—lifted off from Pad B, Launch Complex 39, KSC, at 12:49 p.m. EDT on the first lunar orbital mission with complete spacecraft. The Saturn V's S-IVB stage and the spacecraft were inserted into an earth parking orbit of 189.9 by 184.4 kilometers while the onboard systems were checked. The S-IVB engine was then ignited at 3:19 p.m. EDT to place the spacecraft in a trajectory toward the moon. One-half hour later the CSM separated from the S-IVB, transposed, and docked with the lunar module. At 4:29 p.m. the docked spacecraft were ejected, a separation maneuver was performed, and the S-IVB was placed in a solar orbit by venting residual propellants. TV coverage of docking procedures was transmitted to the Goldstone, Calif., tracking station for worldwide, commercial viewing.

On May 19 the crew elected not to make the first of a series of midcourse maneuvers. A second preplanned midcourse correction that adjusted the trajectory to coincide with a July lunar landing trajectory was executed at 3:19 p.m. The maneuver was so accurate that preplanned third and fourth midcourse corrections were canceled. During the translunar coast, five color TV transmissions totaling 72 minutes were made of the spacecraft and the earth.

At 4:49 p.m. EDT on May 21 the spacecraft was inserted into a lunar orbit of 110.4 by 315.5 kilometers. After two revolutions of tracking and ground updates, a maneuver circularized the orbit at 109.1 by 113.9 kilometers. Astronaut Cernan then entered the LM, checked all systems, and returned to the CM for the scheduled sleep period.

On May 22 activation of the lunar module systems began at 11:49 a.m. EDT. At 2:04 p.m. the spacecraft were undocked and at 4:34 p.m. the LM was inserted into a descent orbit. One hour later the LM made a low-level

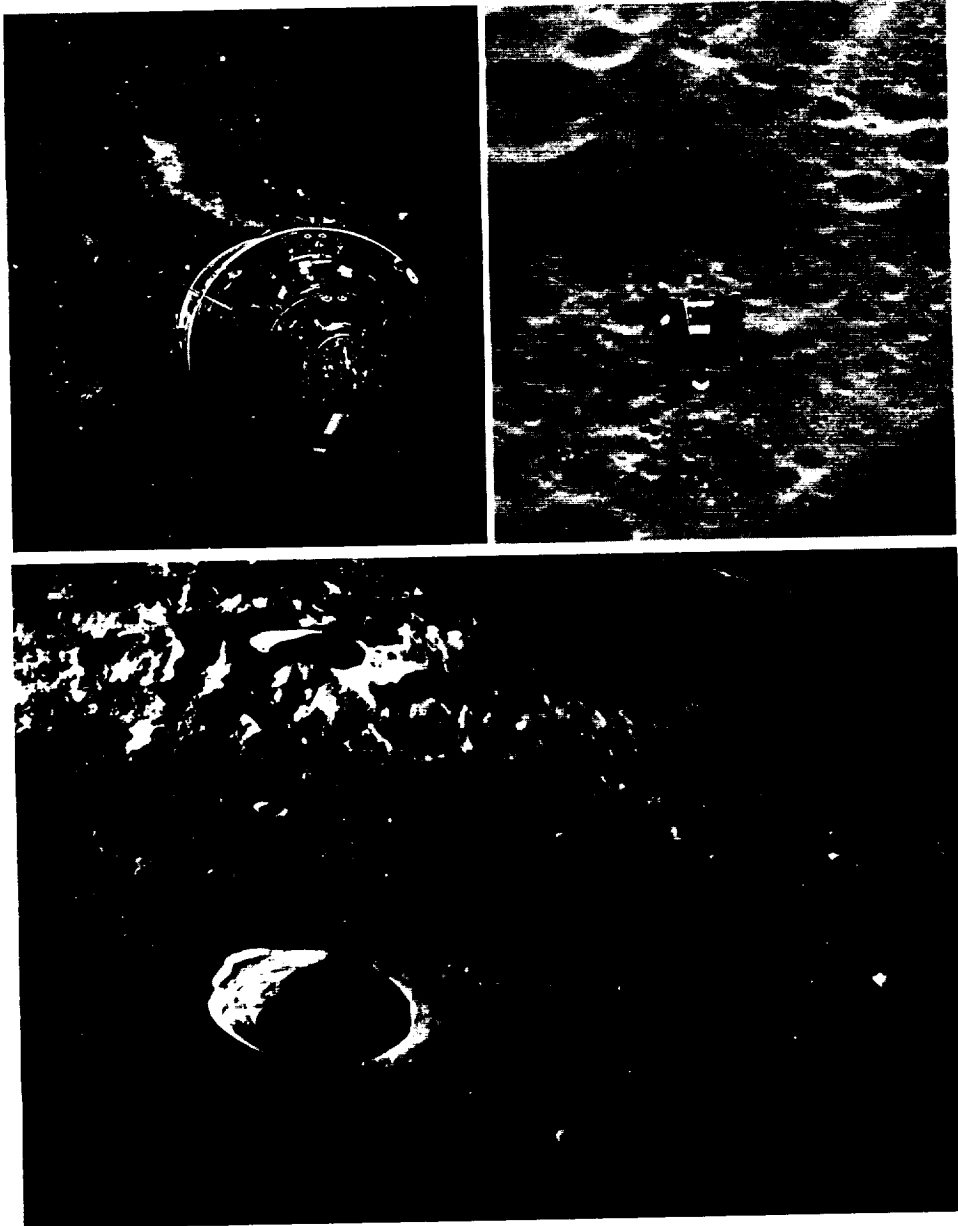

Astronaut John W. Young in the *Apollo 10* command module passes 97 kilometers above unnamed craters on the far side of the moon while Thomas P. Stafford and Eugene A. Cernan descend in the separated LM to within 25 000 meters of the surface. The returning LM—its descent stage jettisoned—was photographed from the CSM before the spacecraft redocked in orbit. On the near side of the moon, Triesnecker Crater was photographed from the CSM; terrain features are typical of the northeastern Central Bay area and highlands along the border of Central Bay. The smooth floor of the Sea of Vapors extends from the highlands to the horizon, 600 kilometers from the spacecraft. Triesnecker Crater is about 27 kilometers in diameter. The intersecting linear features to its right are the Triesnecker Rilles.

1969

May

pass at an altitude of 15.4 kilometers over the planned site for the first lunar landing. The test included a test of the landing radar, visual observation of lunar lighting, stereo photography of the moon, and execution of a phasing maneuver using the descent engine. The lunar module returned to dock successfully with the CSM following the eight-hour separation, and the LM crew returned to the CSM.

The LM ascent stage was jettisoned, its batteries were burned to depletion, and it was placed in a solar orbit on May 23. The crew then prepared for the return trip to earth and after 61.5 hours in lunar orbit a service propulsion system TEI burn injected the CSM into a trajectory toward the earth. During the return trip the astronauts made star-lunar landmark sightings, star-earth horizon navigation sightings, and live television transmissions.

Apollo 10 splashed down in the Pacific at 12:52 p.m. EDT on May 26, 5.4 kilometers from the recovery ship. The crew was picked up and reached the recovery ship U.S.S. *Princeton* at 1:31 p.m. All primary mission objectives of evaluating performance and support and the detailed test objectives were achieved. (Objectives of all the Apollo flights are shown in Appendix 5.)

MSC, "Apollo 10 (AS-505) Flight Summary," undated; MSC, "Apollo 10 Mission Report" (MSC-00126), August 1969; NASA OMSF, "Manned Space Flight Weekly Reports," May 9, 26, 1969; memo, R. O. Middleton, KSC, to distr., "Apollo 10 (AS-505) Quick Look Assessment Report," May 22, 1969.

19

Recent serious incidents were reported at MSC, involving mercury and affecting ground support equipment or Apollo flight hardware. These incidents reflected the relaxation of safety disciplinary procedures required in handling mercury and mercury-filled instruments. To preclude further such incidents, stringent regulations were imposed governing the acquisition, use, and disposition of mercury at MSC.

Memo, Robert R. Gilruth, MSC, to distr., "Mercury Contamination Control," May 19, 1969.

19

Vision distortion was found when looking through the pressure garment assembly helmet during Water Immersion Facility training activities at MSC. Curvature of the helmet caused objects to appear distorted, hampering crew training. Studies were being made in an effort to correct the problem. Negotiations were also under way with the Department of the Navy to provide a modified indoctrination course in open-circuit SCUBA for a number of astronauts, to ensure their safety while training in the Water Immersion Facility.

Memo, Director of Flight Crew Operations to Director of Medical Research and Operations, "Vision distortion while training in the Water Immersion Facility (WIF)," May 19, 1969; ltr., D. K. Slayton, MSC, to B. J. Semmes, Jr., Department of the Navy, May 19, 1969.

19

In a telephone conference, MSC personnel and members of the Interagency Committee on Back Contamination agreed to eliminate the requirement for a postlanding ventilation filter for Apollo 12, approve a plan for sterilization of the CM in the Lunar Receiving Laboratory (LRL), release

the spacecraft at the same time as the crew release, and approve the LRL Bioprotocol Summary. The ICBC planned to meet on June 5 to complete planning and documentation for Apollo 11.

1969

May

Memo, Richard S. Johnston, MSC, to distr., "ICBC Telephone Conference Summary and Action Items," May 21, 1969; NASA OMSF, "Manned Space Flight Report—May 26, 1969."

MSFC was authorized to proceed with development of a manned lunar roving vehicle for use on the Apollo missions beginning in mid-1971. A meeting was scheduled for June 6 in Washington to establish requirements for development of the vehicle.

27

TWX, Lee R. Scherer, NASA Hq., to Wernher von Braun and William R. Lucas, MSFC; Robert R. Gilruth and John D. Hodges, MSC; and Kurt H. Debus, KSC, May 27, 1969.

Apollo Program Director Sam C. Phillips wrote to MSC regarding a Flight Readiness Review action item on translunar injection (TLI: insertion into a trajectory toward the moon) dispersions after manual guidance for TLI on Apollo missions. He enclosed a memorandum prepared by W. G. Heffron of Bellcomm, Inc., on the subject. Phillips stated that fuel reserves on *Apollo 10* were such that dispersions seemed acceptable and he would have permitted use of manned guidance during TLI if it had been needed. He pointed out that margins would be much less for the Apollo 11 mission, and that it would be necessary either to reduce the dispersions or limit the use of the capability. ASPO Manager George M. Low replied to the letter on June 13 and submitted the following comments for consideration: ". . . I see little advantage to not attempting manual launch vehicle guidance for TLI. . . . If the dispersions are within the 120 feet [37 meters] per second budgeted for translunar midcourse corrections, the mission would be continued as planned. If the dispersions are within 270 feet [82 meters] per second, the mission would be completed utilizing a slower transearth trajectory. If the dispersions are very large, the mission would be limited to a circumlunar flight in which all of the service propulsion system and LM descent stage propellants could be used for midcourse corrections. . . ."

27

Ltrs., Phillips to Low, "Manual Launch Vehicle Guidance—TLI Dispersion," May 27, 1969; Low to Phillips, "Manual launch vehicle guidance—TLI dispersions," June 13, 1969.

Apollo Program Office Change Control Board (CCB) Directive No. 140 assigned Experiment S080, Solar Wind Composition, to the first lunar landing mission. CCB Directive No. 156 requested MSC to also include this experiment on the second lunar landing mission.

June

3

TWX, S. C. Phillips, NASA Hq., to G. M. Low, MSC, June 4, 1969.

The early engineering evaluation of the *Apollo 10* launch vehicle, Saturn V AS-505, indicated that the major flight objectives were accomplished. Indications were that all detailed test objectives were also accomplished.

3

The basic performance of the Saturn V was satisfactory, but the following problem areas were identified for more extensive investigation: (1) The

1969

June

S-IVB stage auxiliary hydraulic pump performance degraded during S-IVB second burn. The hydraulic system cycle after second burn also indicated degraded pump performance. (2) Astronauts reported low-frequency lateral and longitudinal oscillations throughout the S-IVB first and second burn, with high-frequency vibration superimposed beginning at 4 minutes 40 seconds into second burn and continuing until engine cutoff. While the associated amplitudes of both high and low frequency were well within structural and component vibration qualification levels, a priority effort to identify the source of these vibrations was under way.

Ltr., Lee B. James, MSFC, to Samuel C. Phillips, NASA Hq., June 3, 1969, with encl., "Saturn AS-505 M + 5 Day Report," June 3, 1969.

3

In a report to the ASPO Manager, the Chief of MSC's Systems Engineering Division described Apollo Site Selection Board (ASSB) action on proposed landing sites for the Apollo 12 mission. The MSC recommendation was to land at either the *Surveyor III* or *Surveyor I* site if Apollo 11 landed in either Apollo site 2 or site 3. Earlier, on January 10, Benjamin Milwitzky, NASA Hq., had said, "There appears to be much merit in landing close to one or more Surveyors." He pointed out that "reexamination of disturbances in the lunar surface created by Surveyor landings, the study of unique lunar features seen by Surveyors, and the return to Earth of objects identified by Surveyors as scientifically important can greatly enhance the scientific and technological value of subsequent Apollo landings. . . ."

MSC informed NASA Hq. on June 12 that it had analyzed landing terrain in Hipparchus and Fra Mauro and concluded that these areas were too rough to be given consideration for the Apollo 12 mission. At the same time, MSC recommended that ASSB reconsider the *Surveyor III* site as a prospective site for that mission. On June 16, Apollo Program Director Sam C. Phillips wrote that Fra Mauro and Hipparchus would not be considered as landing sites for the Apollo 12 mission and that he would entertain consideration of the *Surveyor III* site following analysis of its scientific desirability in a meeting of the Group for Lunar Exploration Planning at MSC on June 17 and subsequent recommendations by MSC and NASA Hq. OMSF staff members.

Memos, Benjamin Milwitzky, NASA Hq., to Apollo Lunar Exploration Office Director, NASA Hq., "Biasing Apollo Missions to Land Near Surveyor Spacecraft on the Moon," Jan. 10, 1969; Chief, Systems Engineering Div., MSC, to ASPO Manager, "Apollo Site Selection Board trip report—June 3, 1969," dated June 10, 1969; TWXs, G. M. Low, MSC, to S. C. Phillips, NASA Hq., "Lunar Landing Sites for H-1 Mission," June 12, 1969; Phillips to Low, "Lunar Landing Sites for H-1 Mission," June 16, 1969.

7

ASPO Manager George Low suggested to MSC Director of Flight Crew Operations Donald K. Slayton that beginning with Apollo 12 Velcro applications should be "in a spacecraft configuration and not vice versa." In the past, Velcro applications had presumably been made in the spacecraft to conform to the configurations used in training.

Memo, Low to Slayton, "Velcro Changes," June 7, 1969.

The CSM 107 (Apollo 11) Flight Readiness Review Board met at MSC. The board heard reviews of government-furnished equipment problems, a special report on camera equipment, scientific experiments and equipment to be used on Apollo 11, medical requirements, operations and procedures to preclude back contamination from the moon, and a structural assessment of the LM/SLA/CSM. CSM Manager Kenneth S. Kleinknecht summarized the status of CSM 107 and emphasized that Apollo Operations Handbook changes must be in by June 15. Board Chairman George S. Trimble, MSC, noted that there seemed to be a tendency to bring more items to the board at this review than before, since this mission was the goal toward which everyone had been working.

1969

June

9

Trimble, MSC, to distr., "Minutes of Meeting, CSM 107, Flight Readiness Review Board," June 9, 1969.

Preparation of Apollo 11 was on schedule for a July 16 launch date. Lunar landmark and landing site mosaics were delivered for flight crew training. A flight readiness test, begun on June 4, had been completed June 6 despite an MSC Mission Control Center power outage that delayed the test for several hours.

9

NASA OMSF, "Manned Space Flight Weekly Report—June 9, 1969;" OMSF, "Apollo Program Weekly Status Report," June 12, 1969.

Studies were being conducted to determine the feasibility of intentionally impacting an S-IVB stage and an empty LM stage on the lunar surface after jettison, to gather geological data and enhance the scientific return of the seismology experiment. Data would be obtained with the ALSEP seismographic equipment placed on the lunar surface during the Apollo 11 or Apollo 12 flight. MSFC and Bellcomm were examining the possibility of the S-IVB jettison; MSC, the LM ascent stage jettison. Intentional impacting of the ascent stage for Apollo 11 was later determined not to be desirable.

9-13

TWXs, Samuel C. Phillips, NASA Hq., to George M. Low, MSC, "LM-5 Ascent Stage Disposition after Jettison," June 13, 1969; Phillips to Low, "Impact of the Ascent Stage on Apollo 11," June 25, 1969; Phillips to MSFC and MSC, "This Is APO CCB Directive No. 158," June 30, 1969; NASA OMSF, "Manned Space Flight Weekly Report—June 9, 1969."

In establishing a task force for hardware development, Apollo Program Director Samuel C. Phillips stated: "We have recently been given . . . approval on our plans for continuing the lunar missions through Apollo 20. We have given authority to the field centers to issue CCA's for the design and the procurement of long lead time items for modifications to the LM and CSM. We have also authorized the procurement of a wheeled vehicle for lunar surface transportation. We are in the process of evaluating over 50 proposals for lunar orbital experiments, and have given MSC authority to procure an already approved experiment group. In short, we are becoming very rapidly involved in the definition and management of the lunar exploration missions."

11

Ltr., Phillips to distr., "Task Force for Hardware Development," June 11, 1969; NASA OMSF, "Manned Space Flight Weekly Report—June 16, 1969."

1969
June
13 Apollo Program Director Phillips wrote MSC ASPO Manager George Low, that "based on the excellent results of the color TV coverage on the Apollo 10 mission . . . I concur with your plan to carry and utilize a color TV camera in the Command Module for Apollo 11 and subsequent missions. . . ."

Ltr., Phillips to Low, "Apollo On-board Color TV," June 13, 1969.

13 NASA Hq. authorized MSC to modify its contract with Bendix to include a 60- to 90-day effort to define a modified ALSEP design. Additional cost was not to exceed \$300 000.

TWX, Samuel C. Phillips to Robert R. Gilruth, "Design Definition of Modified ALSEP," June 13, 1969.

13 The NASA Associate Administrator for Manned Space Flight, in a message to MSC, said he understood that, subsequent to the MSC Flight Readiness Review (FRR) and the NASA Headquarters Readiness Review of the LLTV, additional modifications had been made to that training vehicle. He requested a return wire indicating the date of the delta Flight Readiness Review and evaluation of the readiness for astronaut LLTV flight. In a reply, several hours later, MSC informed Mueller that a delta FRR had been conducted that date; that the changes in avionics had been extensively ground-checked and demonstrated on two separate test flights on June 9 and June 12; that the MSC board concluded the overall system was ready for astronaut training; and that the plan was to start the Apollo 11 Critical Design Review on the following day.

TWXs, George E. Mueller to Robert R. Gilruth, June 13, 1969; Gilruth to Mueller, June 13, 1969.

17 A seven-day simulation was successfully completed in the Lunar Receiving Laboratory at MSC. The test simulated processing of lunar samples, operation of the mobile quarantine facility and crew reception area, and biolab activities. Action was under way to overcome procedural and equipment difficulties encountered in the vacuum laboratory.

NASA OMSF, "Manned Space Flight Weekly Report—June 23, 1969."

20 Sigurd A. Sjoberg, MSC Deputy Director of Flight Operations, informed MSC management of a list of records that could be set in the Apollo 11 flight. Plans were made to file claims with the Fédération Aéronautique Internationale for:

Class records for lunar missions

1. Duration of stay on the surface of the moon.
2. Duration of stay inside the spacecraft on the surface of the moon.
3. Duration of stay outside the spacecraft on the surface of the moon.
4. Greatest mass landed on the moon.
5. Greatest mass lifted to lunar orbit from the surface of the moon.

6. Duration of stay in lunar orbit (The *Apollo 10* record would be broken if the optional sleep period after rendezvous and before transearth injection were included.)

1969

June

Absolute world record

1. EVA record—duration of stay outside spacecraft.

Memo, Sigurd A. Sjoberg to distr., "World Space Flight Records for the Apollo 11 Mission," June 30, 1969.

Christopher C. Kraft, Jr., MSC Director of Flight Operations, recommended that the following fundamental requirements be considered during the lunar roving vehicle (LRV) design approach: "a. A means of continuous voice communication with one crew member, on or off the LRV to the mother station (LM) and from the mother station to earth, must be provided. b. A simple dead reckoning system should be considered for determining the LRV and crew location at all times in order to provide a safe return of the astronauts to the LM. The accuracy should be sufficient to permit the astronauts to rendezvous with the LM from any point on a sortie. c. The vehicle should be designed so that a telemetry system is not required for operation. However, for crew safety and systems operations, instrumentation may be required."

20

Memo, Kraft to Manager, Advanced Missions Program, "FOD criteria for manned Lunar Roving Vehicle," June 20, 1969.

Preparations for the first manned lunar landing continued on schedule for a July 16 launch of Apollo 11. Dress rehearsal of the countdown was scheduled to begin on Friday, June 27, and to run for 113 hours, including a 6-hour built-in hold. Spacecraft hypergolic loading started on June 18 and was completed on June 23, despite delays caused by weather conditions. A lunar module landing-radar problem was resolved by repainting the base heatshield to reduce the reflectivity. In flight operations, the crew, the controllers, and the recovery operations team were moving ahead with training sessions on schedule. Two days of discussions were held with senior recovery officials on the U.S.S. *Hornet* and no major problems were identified. A second mobile quarantine facility was being deployed aboard the *Hornet* to provide backup support on the bioprotocol. A significant milestone was reached June 18 when the scientific investigators and the Apollo 11 astronauts went through a successful simulation of the EASEP (Early Apollo Surface Experiments Package) activities, ranging from the data plans and procedures to the use of the facilities.

23

NASA OMSF, "Manned Space Flight Weekly Report—June 23, 1969."

The status of the Apollo 11 crew training program as of June 15 was reported to NASA Headquarters by MSC. The summary indicated the crew had completed more than 70 percent of the briefing and reviews, had spent a total of 143 hours on procedures against a programmed 100 hours, had spent

27

1969

June

a total of 71 hours on spacecraft test and checkout procedures against a programmed 68 hours, had spent 167 hours in command module simulators against a requirement for 156, and had accomplished 96 percent of the required 226 hours of training in the LM simulators and about 94 percent of the 180 hours of required special-purpose training. Overall, 92 percent of the training program had been accomplished. The special-purpose training included such items as lunar surface timeline walk-throughs, lunar surface operations preparation and post-walk-throughs, and bench checks. Astronaut Neil Armstrong had successfully completed his LLTV training program by flying a ground run and eight flights on June 14, 15, and 16.

Ltr., Robert R. Gilruth, MSC, to George E. Mueller, NASA Hq., "Flight crew training summaries," June 27, 1969, with encl., "Apollo 11 Crew Training Summary Status as of June 15, 1969."

27

How the decision was reached on who would be the first man to step out onto the moon was reported in a letter by ASPO Manager George M. Low: "Some time during the middle of the night, I had a call from Associated Press informing me that they had a story that Neil Armstrong had pulled rank on Buzz Aldrin to be the first man on the surface of the moon. They wanted to know whether it was true and how the decision was reached concerning who would get out of the LM first.

"To the best of my recollection, I gave the following information:

"a. There had been many informal plans developed during the past several years concerning the lunar timeline. These probably included all combinations of one man out versus two men out, who gets out first, etc.

"b. There was only one approved plan and that was established 2 to 4 weeks prior to our public announcement of this planning. I believe that this was in April 1969.

"c. The basic decision was made by my Configuration Control Board. It was based on a recommendation by the Flight Crew Operations Directorate. I am sure that Armstrong had made an input to this recommendation, but he, by no means, had the final say. The CCB decision was final."

Ltr., Low to B. M. Duff, MSC, "Press Inquiry," June 27, 1969.

July

1

Preparations continued on schedule for a July 16 launch of Apollo 11. Edwin Aldrin, Neil Armstrong, and Michael Collins were in good physical condition and on schedule for their training and mission preparations. Descent and landing simulations were successfully completed. The recovery ship U.S.S. *Hornet* was prepared for the recovery operation. The Goldstone 64-meter dish antenna was ready to support both the Apollo 11 and the Mariner requirements. [*Mariner VI* and *VII*, launched February 24 and March 27, were on their way to July 31 and August 4 flybys of the planet Mars]. Mission control and the worldwide network stations were

completing final simulation and tracking preparations, and the flight plan was ready for distribution.

NASA OMSF, "Manned Space Flight Weekly Report—July 1, 1969."

The Interagency Committee on Back Contamination agreed to the designation of the MSC Director of Medical Research and Operations as the agent to impose a quarantine applicable to the crew, the spacecraft, and the returned lunar materials during any phase of the Apollo 11 mission. He was

A cutaway of the lunar module shows critical components and areas of the ascent stage, top, and the descent stage, below.

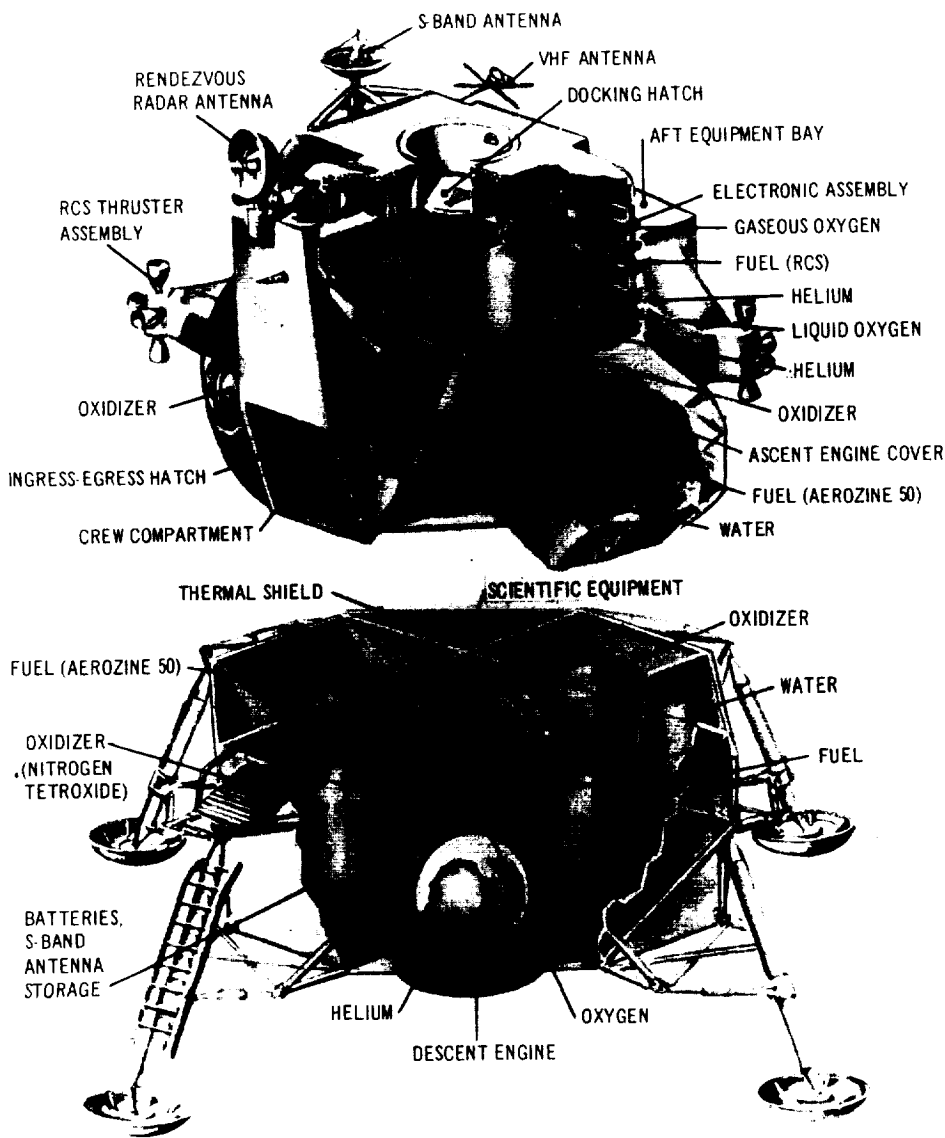

1969

July

authorized to appoint persons at each location and phase of the mission who would have the responsibility of exercising the quarantine authority if necessary.

Ltr., Apollo Mission Director George H. Hage to NASA General Counsel, "Back Contamination and Quarantine—Apollo 11," July 2, 1969.

8

In an effort to stem the increasing number of human errors found in flight hardware, the ASPO Manager appointed a spacecraft walk-down team to take a first-hand look at spacecraft as late as possible before delivery to KSC. Team members selected were highly experienced in their respective fields and thoroughly familiar with the spacecraft. While ASPO recognized that the team could not possibly discover all the possible discrepancies, it hoped that the inspections might help avoid some of the problems experienced in the past.

Ltr., G. M. Low, MSC, to R. A. Petrone, KSC, July 8, 1969.

9

The ASPO Manager for the command and service modules expressed belief that costs could be reduced and others avoided by the effective use of agency resources in many areas. However, he pointed out that the very nature of the program—that is, one operating in a research and development atmosphere—would result in higher costs than would a mass-production program.

Memo, Kenneth S. Kleinknecht to Manager, Apollo Spacecraft Program, "Cost of manned flight programs," July 9, 1969.

9

Microscopic examination of dust particles collected from the spacecraft after the *Apollo 10* mission and of samples collected from the inside of nine garments worn by the *Apollo 10* astronauts confirmed preliminary findings that the itching experienced by the astronauts was due to the insulation in the tunnel hatch of the command module. Investigation showed the fiberglass insulation had flaked off during LM pressurization. Review of thermal conditions indicated the insulation was not essential and it was eliminated from future vehicles.

Ltr., Kenneth S. Kleinknecht, MSC, to George W. Jeffs, North American Rockwell Corp., July 9, 1969.

16-24

Apollo 11 (AS-506)—with astronauts Neil A. Armstrong, Michael Collins, and Edwin E. Aldrin, Jr., aboard—was launched from Pad A, Launch Complex 39, KSC, at 9:32 a.m. EDT July 16. The activities during earth-orbit checkout, translunar injection, CSM transposition and docking, spacecraft ejection, and translunar coast were similar to those of *Apollo 10*. (See entry for May 18-26, 1969.)

At 4:40 p.m. EDT July 18, the crew began a 96-minute color television transmission of the CSM and LM interiors, CSM exterior, the earth, probe and drogue removal, spacecraft tunnel hatch opening, food preparation,

1969

July

and LM housekeeping. One scheduled and two unscheduled television broadcasts had been made previously by the *Apollo 11* crew.

The spacecraft entered lunar orbit at 1:28 p.m. EDT on July 19. During the second lunar orbit a live color telecast of the lunar surface was made. A second service-propulsion-system burn placed the spacecraft in a circularized orbit, after which astronaut Aldrin entered the LM for two hours of housekeeping including a voice and telemetry test and an oxygen-purge-system check.

At 8:50 a.m. July 20, Armstrong and Aldrin reentered the LM and checked out all systems. They performed a maneuver at 1:11 p.m. to separate the LM from the CSM and began the descent to the moon. The LM touched down on the moon at 4:18 p.m. EDT July 20. Armstrong reported to mission control at MSC, "Houston, Tranquility Base here—the *Eagle* has landed." (*Eagle* was the name given to the *Apollo 11* LM; the CSM was named *Columbia*.) Man's first step on the moon was taken by Armstrong at 10:56 p.m. EDT. As he stepped onto the surface of the moon, Armstrong described the feat as "one small step for a man—one giant leap for mankind."

Aldrin joined Armstrong on the surface of the moon at 11:15 p.m. July 20. The astronauts unveiled a plaque mounted on a strut of the LM and read to a worldwide TV audience, "Here men from the planet earth first set foot on the moon July 1969, A.D. We came in peace for all mankind." After raising the American flag and talking to President Nixon by radiotelephone, the two astronauts deployed the lunar surface experiments assigned to the mission and gathered 22 kilograms of samples of lunar soil and rocks. They then reentered the LM and closed the hatch at 1:11 a.m. July 21. All lunar extravehicular activities were televised in black-and-white. Meanwhile, Collins continued orbiting moon alone in CSM *Columbia*.

The *Eagle* lifted off from the moon at 1:54 p.m. EDT July 21, having spent 21 hours 36 minutes on the lunar surface. It docked with the CSM at 5:35 p.m. and the crew, with the lunar samples and film, transferred to the CSM. The LM ascent stage was jettisoned into lunar orbit. The crew then rested and prepared for the return trip to the earth.

The CSM was injected into a trajectory toward the earth at 12:55 a.m. EDT July 22. Following a midcourse correction at 4:01 p.m., an 18-minute color television transmission was made, in which the astronauts demonstrated the weightlessness of food and water and showed shots of the earth and the moon.

At 12:15 p.m. EDT July 24 the *Apollo 11's* command module *Columbia* splashed down in the mid-Pacific, about 24 kilometers from the recovery ship U.S.S. *Hornet*. Following decontamination procedures at the point of

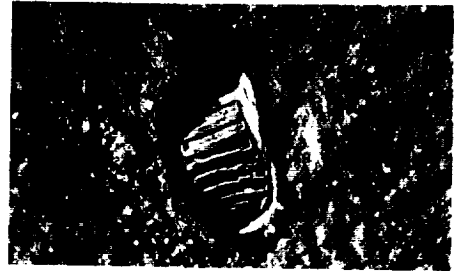

The *Apollo 11* space vehicle thrusts upward from Kennedy Space Center July 16, 1969, on the flight that fulfilled President Kennedy's May 26, 1961, challenge to land man on the moon and return him safely to the earth by the end of the decade. On the lunar surface July 20–21, astronaut Edwin E. Aldrin's helmet visor reflects the LM and Neil A. Armstrong standing in the Sea of Tranquility. Armstrong also photographed Aldrin deploying the Solar Wind Composition Experiment and as he paused by the deployed United States flag. Leaving footprints behind in the lunar soil after EVA completion, the LM rises to meet the CSM and pilot Michael Collins for the return to earth—the destination visible over the lunar horizon.



splashdown, the astronauts were carried by helicopter to the *Hornet*, where they entered a mobile quarantine facility to begin a period of observation under strict quarantine conditions. The CM was recovered and moved to the quarantine facility. Sample containers and film were flown to Houston.

1969

July

1969
July All primary mission objectives and all detailed test objectives of *Apollo 11* were met, and all crew members remained in good health. (Objectives of all the Apollo flights are shown in Appendix 5.)

MSC, "Apollo 11 (AS-506) Flight Summary," undated; MSC, "Apollo 11 Mission Report" (MSC-00171), November 1969; "Apollo 11 Sequence of Events," July 30, 1969; KSC, "Apollo 11 (AS-506) Quick Look Assessment Report," July 23, 1969; NASA Hq., "Mission Director's Summary Report, Apollo 11," July 24, 1969; *Apollo 11 Mission Report* (NASA SP-238, 1971).

19 During the *Apollo 11* mission, members of the Lunar International Observer Network (LION) made continuous observations of a lunar area where illuminations had been noted. At 1845 GMT (2:45 p.m. EDT), the astronauts sighted an illumination in the Aristarchus region, the first time that a lunar transient event was sighted by an observer in space. The sighting was confirmed by a LION observer in West Germany.

NASA OMSF, "Manned Space Flight Weekly Report—August 11, 1969."

July 27–
August 1 The scientific experiments planned for the *Apollo 11* mission were reported successfully accomplished. The passive seismometry had recorded a series of minor events and withstood temperatures of up to 364 kelvins (195°F). The average temperature in the central station reached 361 K (190°F) at solar noon on July 27 and dropped to 243 K (157°F) on July 31. MSC appointed a study group to investigate the causes of the higher than predicted temperature levels. Lick Observatory in California successfully acquired beams from the laser retroreflector on August 1 and was continuing ranging activities.

NASA OMSF, "Manned Space Flight Weekly Report—August 11, 1969."

28 To guard against cannibalization, misuse, or destruction of any part of the lunar mission support equipment, spacecraft, and recovered equipment (however insignificant it might seem) from the *Apollo 11* mission, NASA Hq. specified the following steps: All recovered items would be identified, recorded, and inventoried as soon as quarantine, decontamination, and deactivation activities permitted. All items would be placed in secure storage, under guard if necessary. No removal would be permitted that would deface exterior portions of the spacecraft or portions of the cabin visible through the hatch or windows. No destructive testing would be permitted. Items returned to contractors for testing would be under bond. Preparation for public display would be expedited.

Ltr., Samuel C. Phillips, NASA Hq., to George M. Low, MSC, "Control and Disposition of Apollo 11 Hardware," July 28, 1969.

NASA issued a tentative planning schedule for the Apollo program:

<i>Flight</i>	<i>Launch Plans</i>		<i>Tentative Landing Area</i>
Apollo 12	November	1969	Oceanus Procellarum lunar lowlands
Apollo 13	March	1970	Fra Mauro highlands
Apollo 14	July	1970	Crater Censorinus highlands
Apollo 15	November	1970	Littrow volcanic area
Apollo 16	April	1971	Crater Tycho (<i>Surveyor VII</i> impact area)
Apollo 17	September	1971	Marius Hills volcanic domes
Apollo 18	February	1972	Schroter's Valley, riverlike channel-ways
Apollo 19	July	1972	Hyginus Rille region-Linear Rille, crater area
Apollo 20	December	1972	Crater Copernicus, large crater impact area

NASA OMSF, "Manned Space Flight Weekly Report—July 28, 1969."

1969

July

29

The Secretary of Defense announced the assignment of Lt. Gen. Samuel C. Phillips (USAF), who had been serving as Apollo Program Director in the NASA Office of Manned Space Flight, to be Commander of the Air Force Space and Missile Systems Organization (SAMSO) in Los Angeles. He would assume his new responsibilities in the Air Force effective September 1.

31

NASA Announcement of Key Personnel Change, "DOD Announcement of General Phillips' Air Force Assignment," July 31, 1969.

During the *Apollo 11* management debriefing, the ASPO Manager noted a number of items requiring investigation. During separation from the S-IVB stage, the CSM autopilot apparently had difficulty determining direction of rotation. After the CSM hatch removal, there was a strong odor of burnt material in the tunnel. The leveling device on one of the experiment packages did not work. The closeup stereo camera was hard to operate and tended to fall over. The temperature in the lunar module was too cold during sleep periods. The biological isolation garment was uncomfortably hot and its visor fogged. The crew observed flashes at the rate of about one per minute in the command module at night.

August

1

Memo, George M. Low, MSC, to Donald D. Arabian, MSC, "Apollo 11 management debriefing," Aug. 1, 1969.

George Low, James McDivitt, Neil Armstrong, and Edwin Aldrin discussed lunar exploration that could be carried out by astronauts walking in spacesuits or riding roving vehicles. The following conclusions were reached: "a. A possible mode of exploration would be to walk 1 hour (3 to 5 miles [5 to 8 kilometers]) to an exploration site; spend 1 to 2 hours at that site; and then return to the LM. b. It would be easy to carry anything that need be carried, provided that it did not require the hands for the purpose.

7

- 1969**
August
- c. A roving vehicle might work if it had extremely large wheels. There appeared to be no significant advantage of using the presently conceived roving vehicle instead of walking. d. All extravehicular excursions should be carried out by two men at a time. e. Excursions should not be carried out beyond the radius of ground communications."
- ASPO Manager, Memo for the Record, "Lunar Exploration," Aug. 13, 1969.
- 7** MSFC-NASA Hq. correspondence emphasized the need to restrict the lunar roving vehicle to a 181-kilogram weight limit. If necessary, range and speed would be traded off to retain this weight limit.
- Ltr., Saverio F. Morea, MSFC, to William E. Stoney, Jr., NASA Hq., Aug. 7, 1969.
- 10** The Interagency Committee on Back Contamination met in Atlanta, Ga. Basing its decision on medical and biological data obtained during a 21-day observation period, the committee lifted the quarantine on the *Apollo 11* crew and the personnel in quarantine with the crew. The CSM was also released from quarantine. However, all loose equipment removed from the spacecraft and held in the Lunar Receiving Laboratory would remain in quarantine until the lunar samples were released. The committee also agreed that a postlanding ventilation filter would not be required on *Apollo 12*.
- Memo, Richard S. Johnston, MSC, to ASPO Manager, "Apollo Back Contamination Program," Aug. 11, 1969.
- 12** During lunar module checkout activities at KSC, the LM-6 (for *Apollo 12*) guidance computer was removed and replaced because of an unexpected restart during panel revalidation.
- NASA OMSF, "Manned Space Flight Weekly Report—August 18, 1969."
- 13** S. C. Phillips, NASA Hq., suggested that for communications on the lunar surface a long, deployable antenna might work. He suggested that an antenna about 30 meters long could be used. The antenna would be rolled up like a tape measure and would curl into a cylinder when deployed, somewhat like an antenna that had been used on the CSM.
- Ltr., G. M. Low, MSC, to J. A. McDivitt, MSC, "Discussions with General Phillips," Aug. 13, 1969.
- 18** The Lunar Roving Vehicle Task Team, which had been established at MSFC on April 7, was reconstituted as the Lunar Mobility Task Team. Its function would be to direct and coordinate MSFC efforts to conceive, design, and develop various modes of lunar transportation systems.
- MSFC Organization Announcement, "Lunar Roving Vehicle Task Team Reconstituted as the Lunar Mobility Task Team," Aug. 18, 1969.
- 19** The *Apollo 11* seismic experiment package on the moon was reactivated. Indications were that the unit was fully functional. The laser reflector was

also operating well. Scientists at the McDonald Observatory, Fort Davis, Tex., conducted ranging operations that established the distance between the earth and the moon, to within an accuracy of 4 meters as 373 794.3333 kilometers.

1969
August

NASA OMSF, "Manned Space Flight Weekly Report—August 25, 1969."

MSC rejected a Grumman proposal to use the LM as a lunar reconnaissance module. MSC pointed out that an MSC special task team had recently studied a number of proposals for lunar reconnaissance. These included use of a command module test vehicle, the AAP multiple docking adapter, the subsystem test bed, the ascent stage of the LM, and the entire LM vehicle.

20

Ltrs., Joseph G. Gavin, Jr., Grumman Aerospace Corp., to Robert R. Gilruth MSC, July 18, 1969; Gilruth to Gavin, Aug. 20, 1969.

NASA named Rocco A. Petrone, Director of Launch Operations at KSC, to succeed Samuel C. Phillips as Director of the Apollo Program effective September 1. (See also July 31, 1969, entry.)

22

NASA News Release 69-124, "Petrone Named Apollo Director," Aug. 22, 1969.

In response to a query from MSFC, MSC took the position that primary batteries as opposed to secondary (rechargeable batteries) should be used to power the lunar roving vehicle. Concern was expressed that a solar array recharge assembly would introduce an extra complexity into the LM payload packaging and the roving vehicle servicing requirements and would contribute to a loss in effective EVA time because astronauts would need time to deploy the solar array and connect it to the rover.

26

Ltrs. Saverio F. Morea, MSFC, to John D. Hodge, MSC, July 14, 1969; Hodge to Morea, "Power requirements for the Lunar Roving Vehicle (LRV)," August 26, 1969.

Analyses of the radioactive decay of Argon 40 and Neon 21 in two lunar samples indicated that the minimum age of the part of the Sea of Tranquility from which the samples were obtained was about 3.1 billion years—plus or minus 200 million years.

September

2

NASA OMSF, "Manned Space Flight Weekly Report—September 2, 1969."

After the preliminary examination of *Apollo 11* lunar samples, the Department of the Interior made a number of recommendations for processing samples to be brought from the moon by the *Apollo 12* mission.

8

Memo, E. C. T. Chao and R. L. Smith, Dept. of Interior, to W. Hess, A. J. Calio, and P. R. Bell, MSC, "Recommendations and suggestions for preliminary examination of *Apollo 12* returned lunar samples," Sept. 6, 1969; ltr., R. S. Johnston, MSC, to Chao and Smith, Sept. 23, 1969.

The first reported weights of *Apollo 11* lunar samples were inaccurate because of a number of variables that could not be eliminated until after quarantine was lifted, MSC told NASA Hq. Because of the concern this inaccuracy had generated, procedures were being developed for future

16

1969
September

missions to permit more accurate determination of sample weights early in the Lunar Receiving Laboratory processing cycle.

Memo, George M. Low, MSC, to Rocco A. Petrone, NASA Hq., "Apollo 11 Lunar Sample Weight," Sept. 16, 1969.

17 The Interagency Committee on Back Contamination recommended changes in Apollo mission recovery procedures, including:

- Elimination of the biological isolation garment and, instead, use of a mask and clean room garment for astronauts returning from lunar missions.

- Design changes to improve the spacecraft and mobile quarantine facility tunnel operation.

Memo for record, Richard S. Johnston, MSC, "Apollo 12 Back Contamination Program," Sept. 17, 1969; memo, Donald K. Slayton, MSC, to Special Assistant to Director, "Crew comments on the use of biological isolation garment (BIG)," Oct. 6, 1969.

19 MSC replied to a query that 136 flags of other nations, the U.N. flag, and flags from each state and territory of the United States had been flown on *Apollo 11*. The flags, measuring 10.16 cm x 15.24 cm and made of silk-screened rayon, were procured through available commercial sources. Vacuum packed and stowed in Beta cloth bags for flammability protection the flags were not removed from the containers during the flight. The American flag left on the surface of the moon would probably last for a considerable period, since the only deterioration expected would be from the solar wind.

Ltr., Donald K. Slayton, MSC, to Mrs. Seddon Sadtler, ca. Sept. 19, 1969.

23 In response to a query from *Guinness Superlatives*, London, as to the maximum distance from the earth reached by *Apollo 8* and *Apollo 11*, MSC said the maximum distance for *Apollo 8* was 377 348.704 kilometers, during the 10th lunar revolution. The maximum distance from the earth for *Apollo 11* was 389 921.3764 kilometers, during lunar orbit insertion. However, because of the requirement to exceed previously established space records by 10 percent, the altitude achieved on *Apollo 8* was still the recognized record.

Ltr., George M. Low, MSC, to Norris D. McWhirter, *Guinness Superlatives*, Sept. 23, 1969.

25 James A. McDivitt was appointed ASPO Manager at MSC. George M. Low, former ASPO Manager was temporarily on special assignment at MSC to plan future MSC programs and work on organizational matters.

MSC News Release, 69-66, Sept. 25, 1969.

25-26 A Manned Space Flight Awareness seminar was held at MSC. The seminar, attended by some 500 industry and government representatives, emphasized the need for maintaining the dedication and motivation that led to the success of *Apollo 11*.

NASA OMSF, "Manned Space Flight Weekly Report—September 29, 1969."

An exchange of correspondence that had begun in April formalized the suggestion that a series of handbooks on the "lessons learned" from the Apollo program should be prepared as an aid to future programs.

Ltrs., Samuel C. Phillips, NASA Hq., to George M. Low, MSC, April 30, 1969; Low to Phillips, May 5, 1969; memos, Low to Director of Flight Operations, "Apollo experience reports," Sept. 23, 1969; Christopher C. Kraft, Jr., MSC, to distr., "Documentation of FOD Apollo experience," Oct. 3, 1969.

1969

October

3

Program responsibility for the Saturn launch vehicles was divided, at the Headquarters level, between the Apollo Program Office and the Apollo Applications Program. Overall responsibility for the Saturn V remained with the Apollo Program Office, while overall responsibility for the Saturn IB vehicle was assigned to Apollo Applications.

Memorandum of Understanding between the Apollo and Apollo Applications Program Offices on Saturn Vehicle Management Interfaces, signed Rocco A. Petrone, APO, Oct. 6, 1969, and William C. Schneider, AAP, Oct. 13, 1969.

6

Major milestones were reached for extending astronauts' staytime on the moon and increasing their mobility for the Apollo 16-20 missions. Modifications in the A7L spacesuit incorporating improved waist mobility were authorized, and letter contract authority for the portable life support system/secondary life support system was approved.

Minutes of Manned Space Flight Management Council Meeting, Oct. 15, 1969.

10

A portion of the Apollo 12 mission would be devoted to an examination of *Surveyor III* and recovery of its TV camera and thermal-switch glass mirror fragments, MSC announced. Recovery of the glass fragments was important to Jet Propulsion Laboratory, to provide data for designing thermal switches for the Mercury-Venus Mariners to be flown in 1973. However, recovery of the splinters could easily cause cuts and leaks in the astronauts' gloves; extreme caution would be required. The following procedures were recommended: use of a line during the initial solo descent into the *Surveyor III* crater, to determine the footing and climbing situation before both crewmen descended into the crater, and recovery of thermal-switch glass fragments by a suitable tool such as tweezers, to prevent glove damage.

Memo, James A. McDivitt, MSC, to distr., "Apollo 12 Surveyor III safety review and recommendation," Oct. 18, 1969; Apollo 12 Surveyor III Safety Report, Oct. 10, 1969.

12

Apollo 12 film from the onboard cameras would be delivered in two batches to the Lunar Receiving Laboratory for decontamination within 24 to 36 hours after recovery, MSC reported. Decontamination was expected to take an additional 47 hours for each batch. Film would then be released for processing at the Photographic Technology Laboratory. Photography containing earth views would be prepared at once, but would not be released until authorized by the MSC Director. The flight crew logs would be photographically copied from outside the crew reception area of the LRL using procedures previously developed and agreed on. Original logs would be

21

1969

October

retained within the crew recovery area during the quarantine period, after which they would be picked up by the flight crew.

Memo, Donald D. Arabian, MSC, to Chief, Photographic Technology Laboratory, "Photographic processing and distribution requirements for Apollo 12 (AS-507) mission and scientific photography," Oct. 21, 1969.

22

The Flight Crew Operations Directorate expressed opposition to a major effort to develop a lunar flyer until after the Apollo 16 mission. Plans for Apollo flights 12 through 16 required that the LM be maneuvered to landings at various points of scientific interest on the lunar surface, and experience from *Apollo 11* and partial gravity simulators indicated the crews would be able to accomplish their surface EVA tasks for these missions without the aid of a mobility device.

Memo, Donald K. Slayton, MSC, to Director of Engineering and Development, "Lunar flyer studies," Oct. 22, 1969.

27

MSC Flight Operations informed the Apollo 12 commander that records could be set in a number of areas on the Apollo 12 mission. MSC planned to file claims with the Fédération Aéronautique Internationale for:

Class records for a lunar mission

1. Duration of a lunar mission.
2. Duration of stay in lunar orbit.
3. Duration of stay on lunar surface.
4. Duration of stay in spacecraft on lunar surface.
5. Duration of stay outside spacecraft on lunar surface.

Absolute world record

1. Duration of stay outside spacecraft on lunar surface.

Memo, Sigurd A. Sjöberg, MSC, to the Apollo 12 Commander, "World Space Flight Records for the Apollo 12 Mission," Oct. 27, 1969.

28

A lunar roving vehicle (LRV) cost-plus-incentive-fee contract was awarded to the Boeing Co. LRV-1 was scheduled for delivery on April 1, 1971, leaving only 17 months for vehicle development, production, and tests. The LRV project was managed at MSFC by Saverio F. Morea as a project within the Saturn Program Office. The Boeing Company would manage the LRV project in Huntsville, Ala., under Henry Kudish. General Motors Corp. AC Electronics Defense Research Laboratories in Santa Barbara, Calif., would furnish the mobility system (wheels, motors, and suspension). The Boeing Co. in Seattle, Wash., would furnish the electronics and navigation system. Vehicle testing would take place at the Boeing facility in Kent, Wash., and the chassis manufacturing and overall assembly would take place at the Boeing facility in Huntsville, Ala.

Memo, James A. McDivitt, MSC, to distr., "Lunar Roving Vehicle," Nov. 1, 1969; NASA OMSF, "Manned Space Flight Weekly Report—November 3, 1969."



KSC Director Kurt H. Debus, left, confers with Launch Operations Director Walter J. Kapryan in the Launch Control Center during the Apollo 12 countdown demonstration test, October rehearsal for the second lunar landing mission, set for November 14, 1969, launch.

The Interagency Committee on Back Contamination made the following decisions regarding Apollo 12. The biological isolation garment would not be used. A biological mask and flight suit would be used instead. (See entry of September 17, 1969.) Sterilization of flight film was eliminated. Data tapes would be sterilized if required before the release of samples. The command module would not be decontaminated unless access for postflight testing was required before the sample release date of January 7, 1970.

Memos, Richard C. Johnston, MSC, to distr., "Minutes of ICBC Meeting of October 30, 1969"; Johnston to Director of Medical Research and Operations and Director of Science and Applications, "ICBC Meeting," Oct. 7, 1969.

The spacecraft walk-down team, established by ASPO in July in an effort to stem the increased number of human errors found in flight hardware, made a walkaround inspection of CSM-110 (Apollo 14 hardware). (See entry of July 8, 1969.) Cooperation of North American Rockwell and the Resident Apollo Spacecraft Program Office was excellent during the preparation and implementation of the inspection. No significant discrepancies were found by the inspection team during the several hours of inspection.

Memo, Scott H. Simpkinson, MSC, to ASPO Command and Service Modules Manager, "Action items resulting from CSM-110 engineering walkaround inspection," Nov. 10, 1969.

Christopher C. Kraft, Jr., MSC Director of Flight Operations, suggested that an in-house review reevaluate the Apollo secondary life support system, because of its complexity and cost of development, and at the same time

1969
October
30

November
3

3

1969
November

reexamine the possibilities of an expanded oxygen purge system using identical concepts.

Memo, Christopher C. Kraft, Jr., MSC, to James A. McDivitt, MSC, "SLSS," Nov. 3, 1969.

4

Provision of a thermometer that could be attached to the ALSEP for the Apollo 13 mission, to take a reading of the lunar surface soil temperature, was being considered at MSC.

Memo, James A. McDivitt, MSC, to Robert A. Gardiner, MSC, "Lunar surface temperatures," Nov. 4, 1969.

4-7

Preparations for a November 14 launch of Apollo 12 continued on schedule. Final lunar surface simulations with the crew, network, and Mission Control Center were completed on November 4. The instrument-unit command system, with a replacement transponder and decoder, was successfully retested and in-place repair of four LM-6 circuit breakers was completed, also on November 4. The recovery quarantine equipment and mobile quarantine facility completed checkout for shipment to the recovery ship on November 7. The final consumable analysis showed positive margins for all phases of the mission. Also, on November 7, the countdown to launch began at KSC (T minus 98 hours). A 31-hour hold was scheduled for November 8 with the count resuming at 9:00 a.m. November 9 (T minus 84 hours). The hold was designed to avoid premium wage cost.

NASA OMSF, "Manned Space Flight Weekly Report—November 10, 1969."

6

In an exchange of correspondence between MSFC and MSC concern was expressed over the weight growth of the lunar roving vehicle (LRV) and its payload. As a result, a recommendation was made that MSFC manage the weight of the LRV and MSC the payload weight.

Ltrs., Saverio F. Morea, MSFC, to James A. McDivitt, MSC, "LRV Weight Growth," Nov. 6, 1969; McDivitt to Roy E. Godfrey, MSFC, Dec. 12, 1969.

10

At the request of the Apollo 12 crew, the internal primary guidance and navigational control system targeting for descent was being changed so that the automatic guidance would land LM-6 at *Surveyor III* rather than at a point offset 305 meters east and 153 meters north as originally planned.

Memo, James A. McDivitt, MSC, to distr., "Apollo 12 PGNCs descent targeting is being changed," Nov. 10, 1969; TWX, McDivitt to C. Lee and R. Sheridan, NASA Hq., Nov. 4, 1969.

10

NASA announced the resignation of Associate Administrator for Manned Space Flight George E. Mueller effective December 10. In December Charles W. Mathews was named Acting Associate Administrator for Manned Space Flight until a successor for Mueller was appointed.

Astronautics and Aeronautics, 1969 (NASA SP-4014, 1970), pp. 368, 405; NASA News Release 69-151; NASA Announcement, Dec. 11, 1969.

President Nixon nominated George M. Low, former Apollo Spacecraft Program Manager at MSC, as NASA Deputy Administrator. Low had been with the space program since 1949, when he joined NACA. The Senate confirmed the nomination on November 26. (See also entries of September 25 and December 3, 1969.)

Office of the Federal Register, National Archives and Records Service, *Weekly Compilation of Presidential Documents*, Nov. 17, 1969, p. 1597; *Congressional Record*, Nov. 26, 1969, pp. S15140, D1126.

Apollo 12 (AS-507)—with astronauts Charles Conrad, Jr., Richard F. Gordon, Jr., and Alan L. Bean as the crewmen—was launched from Pad A, Launch Complex 39, KSC, at 11:22 a.m. EST November 14. Lightning struck the space vehicle twice, at 36.5 seconds and 52 seconds into the mission. The first strike was visible to spectators at the launch site. No damage was done. Except for special attention given to verifying all spacecraft systems because of the lightning strikes, the activities during earth-orbit checkout, translunar injection, and translunar coast were similar to those of *Apollo 10* and *Apollo 11* (see entries of May 18–26 and July 16–24, 1969).

During the translunar coast astronauts Conrad and Bean transferred to the LM one-half hour earlier than planned in order to obtain full TV coverage through the Goldstone tracking station. The 56-minute TV transmission showed excellent color pictures of the CSM, the intravehicular transfer, the LM interior, the earth, and the moon.

At 10:47 p.m. EST, November 17, the spacecraft entered a lunar orbit of 312.6 x 115.9 kilometers. A second service propulsion system burn circularized the orbit with a 122.5-kilometer apolune and a 100.6-kilometer perilune. Conrad and Bean again transferred to the LM, where they performed housekeeping chores, a voice and telemetry test, and an oxygen purge system check. They then returned to the CM.

Conrad and Bean reentered the LM, checked out all systems, and at 10:17 p.m. EST on November 18 fired the reaction control system thrusters to separate the CSM 108 (the *Yankee Clipper*) from the LM-6 (the *Intrepid*). At 1:55 a.m. EST November 19, the *Intrepid* landed on the moon's Ocean of Storms, about 163 meters from the *Surveyor III* spacecraft that had landed April 19, 1967. Conrad, shorter than Neil Armstrong (first man on the moon, July 20), had a little difficulty negotiating the last step from the LM ladder to the lunar surface. When he touched the surface at 6:44 a.m. EST November 19, he exclaimed, "Whoopee! Man, that may have been a small step for Neil, but that's a long one for me."

Bean joined Conrad on the surface at 7:14 a.m. They collected a 1.9-kilogram contingency sample of lunar material and later a 14.8-kilogram selected sample. They also deployed an S-band antenna, solar wind composition experiment, and the American flag. An Apollo Lunar Surface Experiments Package with a SNAP-27 atomic generator was deployed about 182 meters from the LM. After 3 hours 56 minutes on the lunar

1969

November

13

14-24

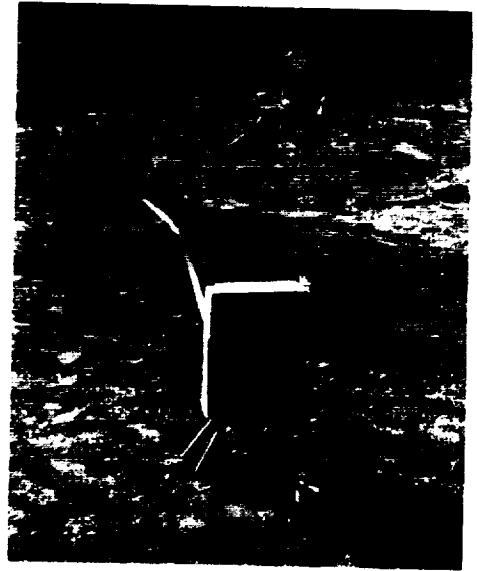

Apollo 12 astronauts Alan L. Bean, descending from the LM, and Charles Conrad, Jr., explore the lunar surface in the Ocean of Storms November 19–20, 1969, using tools from a carrier and deploying experiments. The Cold Cathode Ion Gauge would indicate atmospheric density and any particle density variation, and the Lunar Ionosphere Detector would measure characteristics of positive ions at the surface. In the second EVA period, Conrad examines *Surveyor III*, which had landed on the moon April 19, 1967; the LM *Intrepid* is on the horizon.

1969
November

surface, the two astronauts entered the *Intrepid* to rest and check plans for the next EVA.

The astronauts again left the LM at 10:55 p.m. EST November 19. During the second EVA, Conrad and Bean retrieved the lunar module TV camera for return to earth for a failure analysis, obtained photographic panoramas, core and trench samples, a lunar environment sample, and assorted rock,

dirt, bedrock, and molten samples. The crew then examined and retrieved parts of *Surveyor III*, including the TV camera and soil scoop. After 3 hours 49 minutes on the lunar surface during the second EVA, the two crewmen entered the LM at 2:44 a.m. EST November 20. Meanwhile astronaut Gordon, orbiting the moon in the *Yankee Clipper*, had completed a lunar multispectral photography experiment and photographed proposed future landing sites.

At 9:26 a.m. EST November 20, after 31 hours 31 minutes on the moon, *Intrepid* successfully lifted off with 34.4 kilograms of lunar samples. Rendezvous maneuvers went as planned. The LM docked with the CSM at 12:58 p.m. November 20. The last 24 minutes of the rendezvous sequence was televised. After the crew transferred with the samples, equipment, and film to the *Yankee Clipper*, the *Intrepid* was jettisoned and intentionally crashed onto the lunar surface at 5:17 p.m. November 20, 72.2 kilometers southeast of *Surveyor III*. The crash produced reverberations that lasted about 30 minutes and were detected by the seismometer left on the moon.

Apollo 12 commander Conrad talks by phone from the Mobile Quarantine Facility to members of his family. Conrad and astronauts Bean (right) and Gordon arrived at Ellington Air Force Base from Hawaii on a USAF C-141 transport aircraft November 29, 1969, after November 24 splashdown.



1969

November

1969
November

At 3:49 p.m. EST November 21, the crew fired the service propulsion system engine, injecting the CSM into a transearth trajectory after 89 hours 2 minutes in lunar orbit. During the transearth coast, views of the receding moon and the interior of the spacecraft were televised, and a question and answer session with scientists and the press was conducted.

Parachute deployment and other reentry events occurred as planned. The CM splashed down in mid-Pacific at 3:58 p.m. EST November 24, 7.25 kilometers from the recovery ship, U.S.S. *Hornet*. The astronauts, wearing flight suits and biological face masks, were airlifted by helicopter from the CM to the recovery ship, where they entered the mobile quarantine facility. They would remain in this facility until arrival at the Lunar Receiving Laboratory, MSC. The *Apollo 12* mission objectives were achieved and the experiments successfully accomplished. [All Apollo experiments are listed in Appendix 5.]

MSC "Apollo 12 (AS-507) Flight Summary," undated; MSC, "Apollo 12 Mission Report" (MSC-01855), March 1970; MSC Apollo Program Summary Report," preliminary draft, p. 2-38, undated; TWX, F. A. Speer, MSFC, to C. M. Lee, NASA Hq., "Apollo 12 (AS-507) HOSC Report," Nov. 14, 1974; ltr., E. R. Mathews, KSC, to distr., "Apollo 12 (AS-507) Quick Look Assessment Report," Nov. 26, 1969; *Apollo 12 Preliminary Science Report* (NASA SP-235, 1970).

- 15** A review of North American Rockwell Space Division's in subcontract management indicated that its subcontractor schedule and cost performance had been excellent. The quality had been achieved, for the most part, by effective North American Rockwell subcontract management planning and execution of these plans.

Ltr., Kenneth S. Kleinknecht, MSC, to George W. Jeffs, North American Rockwell Corp., Nov. 15, 1969.

- 17** NASA selected an Apollo Orbital Science Photographic Team to provide scientific guidance in design, operation, and data use of photographic systems for the Apollo lunar orbital science program. Chairman was Frederick Doyle of the U.S. Geological Survey. The 14-man team comprised experts from industry, universities, and government.

NASA OMSF, "Manned Space Flight Weekly Report—November 17, 1969."

- 17** NASA discontinued the use of names such "LEO," "ALEM," and "Apollo Lunar Exploration Program" that had been used since *Apollo 11* to identify the lunar exploration phase of the Apollo program. Henceforth, the single-word title "Apollo" would be used when referring to the program. However, additional descriptive language, such as "lunar exploration phase of Apollo" and "Apollo lunar exploration" would continue to be authorized for defining the Apollo program activity. The action was taken to establish uniformity and eliminate misunderstanding.

Ltr., George E. Mueller, NASA Hq., to Robert R. Gilruth, MSC, Nov. 17, 1969; memo, James A. McDivitt, MSC, to distr., "Identification of the current lunar exploration phase of the Apollo Program," Nov. 26, 1969.

Christopher C. Kraft, Jr., was appointed Deputy Director of MSC. Kraft, Director of Flight Operations at MSC since November 1963, succeeded George S. Trimble, Jr., who had resigned September 30.

NASA Announcement, Jan. 18, 1972; NASA News Release 72-11; MSC News Release 69-70.

The MSC Flight Crew Operations Directorate submitted its requirement for a simple lightweight Rover (lunar roving vehicle) guidance and navigation system that would provide the following displayed information to the crew: vehicle heading and heading to the LM, speed in kilometers per hour, total distance traveled in kilometers, and distance to the LM. Requirements were based on the assumptions that the landing area was as well known as for *Apollo 12*, all traverses were preplanned, accurate photo maps were available, and there was MSFN support through voice communications. The Directorate emphasized that it had no requirements for a display of pitch and roll, X and Y coordinates, or time.

Memo, Donald K. Slayton, MSC, to ASPO Manager, "Rover guidance and navigation system," Dec. 1, 1969.

The *Apollo 12* crew program/project debriefing was held. Some areas of concern included the lunar dust which obscured visibility during the landing, a dust problem in the suit connectors after completion of the first extravehicular activity, and wear on the suits after completion of the second EVA.

NASA OMSF, "Manned Space Flight Weekly Report—December 8, 1969."

MSFC Director Wernher von Braun forwarded to MSC Director Robert R. Gilruth an analysis of increasing space scientists' dissatisfaction with the space program. "Ultimate origin" of dissatisfaction was in "the very complex and difficult interfaces between science, engineering, and management" in NASA and governmental systems and "the need for a quick and flexible challenge-and-response capability."

Young scientists from an academic environment found changing from a research scientist to a science administrator difficult; they often preferred active research to desk-and-meetings career.

Many scientists were reluctant to accept the long times between conceptual design and data gathering in space experiments—often 6 to 10 years. The question was not only of patience, graduate student support, and funding continuity, but also of scientific obsolescence.

Scientists felt that science was not as well represented in upper NASA management as were engineering and project management and that high-level decisions were often made without consideration of scientific viewpoints. While recognizing that the space program also had other prime objectives—such as advancement of technology, national achievement, applications, earth resources, and "bringing the world closer together"—

1969

November

26

December

1

2

3

1969
December

they felt that “science is still a stepchild in this family of program objectives.”

The analysis said that a good portion of the problems could be relieved by actions taken by Centers and NASA Hq. over the next few months and years. NASA space projects should be structured to give more scientists an opportunity to launch experiments. With the few present scientific flights, only a few scientists could hope to have their experiments flown in their lifetimes. The situation would improve when the Space Shuttle and Space Station were available, but that would not be before 1978 or 1979. With low emphasis on OAO, HEAO, Pioneer, ATM, and planetary flights suggested by the President’s Space Task Group, “we will have almost no good flight experiments prepared, and almost no scientists left in the program, by the time the gates of the shuttle and the station open for science.”

NASA should also find ways to reduce the time span between conception and flight of an experiment. “For Bill Kraushaar, who proposed a measurement of gamma rays with a simple (now almost obsolete) sensor on a Saturn launch vehicle, this time is now 8 years, with no end in sight.” For the Apollo telescope mount principal investigators, “this time will be 8 years, provided that ATM-A is launched early in 1972.”

The Shuttle promised great improvements, but “initiation or continuation of unmanned, relatively unsophisticated spacecraft projects for science payloads” was “highly desirable.”

Procedures for proposal, screening, selection, acceptance, and final approval of experiments were “exceedingly cumbersome and time consuming.” Streamlining requirements after approval—early definition, documentation, reporting, reviews, and administrative actions—as well as the maze of committees, boards, panels, and offices, was urgently recommended.

“Many scientists inside and outside NASA have suggested that NASA should establish, at a high level in the Administrator’s Office, a ‘Chief Scientist’ position with no other functions than to act as a spokesman for . . . scientists who wish to participate in the space program.”

Ltr., von Braun, MSFC, to Gilruth, MSC, Dec. 3, 1969, with encl., memo, Ernst Stuhlinger, MSFC, to von Braun, “Notes on ‘Science in NASA,’” Nov. 7, 1969.

3 George M. Low was sworn in as NASA Deputy Administrator by Thomas O. Paine, NASA Administrator. (See November 13.)

NASA News Release 69-159, Dec. 3, 1969.

15 NASA was considering incorporation of a mobile equipment transporter on LM-8, LM-9, and LM-10, to help with problems such as the *Apollo 12* astronauts had in carrying hand tools, sample boxes and bags, a stereo camera, and other equipment on the lunar surface. The MET also could

extend lunar surface activities to a greater distance from the lunar module. A prototype MET and training hardware were being fabricated and were expected to be available in late December.

1969

December

Memo, James A. McDivitt, MSC, to Rocco A. Petrone, NASA Hq., "Mobile Equipment Transporter (MET)," Dec. 15, 1969.

A lunar roving vehicle preliminary requirements review was held at MSFC. MSC was asked to review the requirement for a roll bar which it had requested in the interest of astronaut safety. Navigation system requirements as defined by MSC would require changes in the design presented by Boeing (see entry of December 1, 1969). Full-length fenders and effects of dust on radiators, sealed joints, and vision needed to be considered and appropriate measures taken in the vehicle design, the review found.

16-18

Ltr., William E. Stoney, NASA Hq., to Roy E. Godfrey, MSFC, and James A. McDivitt, MSC, "Lunar Roving Vehicle Preliminary Requirements Review, December 16-18, 1969," Dec. 24, 1969; memo, Donald K. Slayton, MSC, to David B. Pendley, MSC, "Lunar Rover Vehicle (LRV) crew safety provisions," Dec. 12, 1969.

A configuration control panel for Apollo GFE scientific equipment was established at MSC, with Robert A. Gardiner as chairman. The panel would control proposed changes in Apollo spacecraft GFE science equipment.

18

Memo, James A. McDivitt, MSC, to distr., "Configuration control panel for GFE scientific equipment," Dec. 18, 1969.

Correlation of the *Apollo 12* descent film with the crew's comments during landing indicated that lunar dust first became apparent at about 30 meters from the surface and that from about 12 meters above to the actual touchdown the ground was almost completely obscured by the dust. Because of both *Apollo 11* and *Apollo 12* landing experiences, studies were begun and discussions held about various aspects of lunar dust. An MSC management review in the latter part of January 1970 would include discussions of the basic mechanism of erosion during landing, the possibility of alleviating the effects of erosion on visibility, and an estimate of what could be expected at future lunar landing sites.

22

Memo, James A. McDivitt, MSC, to distr., "Investigation of the effects of lunar dust during LM landing," Dec. 22, 1969; NASA OMSF, "Manned Space Flight Weekly Report—December 22, 1969"; ltr., Robert R. Gilruth, MSC, to Rocco A. Petrone, NASA Hq., "Landing site for Apollo 13," Dec. 18, 1969.

MSC announced the appointment of Sigurd A. Sjoberg as Director of Flight Operations, replacing Christopher C. Kraft, Jr., who had been appointed MSC Deputy Director Nov. 26. Sjoberg had been Deputy Director of Flight Operations since 1963.

28

MSC News Release 70-1, Jan. 1, 1969.

NASA had canceled the Apollo 20 mission and stretched out the remaining seven missions to six-month intervals, Deputy Administrator George M. Low told the press in an interview after dedication of the Lunar Science

1970

January

4

One of the samples collected by Neil Armstrong and Ed Aldrin on the moon July 20, 1969, during the *Apollo 11* mission. This rock was studied at the Lunar Receiving Laboratory; other samples were distributed to scientists in nine countries.

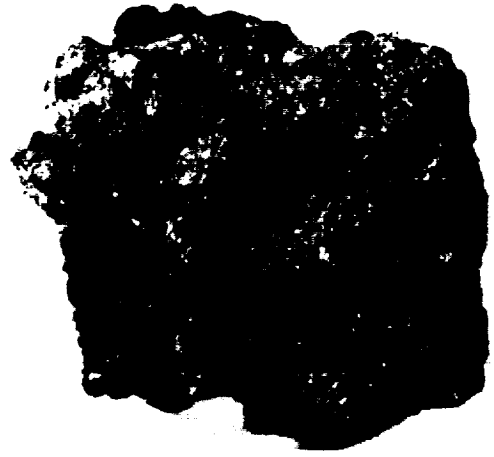

1970
January

Institute (next to MSC in Houston). Budget restrictions had brought the decision to suspend Saturn V launch vehicle production after vehicle 515 and to use the Apollo 20 Saturn V to launch the first U.S. space station in 1972. (See also Jan. 7.)

UPI, "Apollo Missions Extended to '74," *New York Times*, Jan. 5, 1970, p. 10; NASA Administrator Thomas O. Paine in NASA News Release, "NASA Future Plans," press conference transcript, Jan. 13, 1970.

5-8

Detailed reports on the *Apollo 11* sample analyses were presented at the Lunar Science Conference at MSC. Principal investigators covered the fields of geology, mineralogy, petrology, radiogenic isotopes, inorganic and organic chemistry, solar wind and cosmic ray spallation products, magnetic and electrical properties, physical properties, impact metamorphism, and micropaleontology. The results added up to the greatest single advance in the understanding of a planetary-size body attained to date.

Abstract, N. W. Hinners, Bellcomm, Case 340, "Significant Results Reported at the Apollo 11 Lunar Science Conference," Jan. 30, 1970.

6

An MSC Experiments Review Group was established to consider new or late experiments for the Apollo flights. The group would recommend MSC policy on changes in experiments and would serve as a management clearing house.

Memo, James A. McDivitt, MSC, to distr., "Apollo Experiments Review Group," Jan. 6, 1970.

6

North American Rockwell announced a reorganization to strengthen its operating divisions, streamline channels of communication, and place more direct responsibility for performance with top division management.

Ltr., J. Leland Atwood, North American Rockwell Corp., to Robert R. Gilruth, MSC, Jan. 6, 1970.

1970

January

6

North American Rockwell declined to become a member of the Coordinated Aerospace Supplier Evaluation (CASE) organization. North American Rockwell stated that its Certified Special Processors system provided greater effectiveness, that there was no real assurance that a supplier listed in the CASE Register was capable of performing to all the requirements of the indicated specifications, and that participants in CASE were prohibited from any exchange of information concerning supplier inadequacies. Several processors discontinued by North American Rockwell because of poor performance were still enjoying the full benefit of listing in the CASE Register, with the implication of system acceptability and certified-processor status that the listing provided.

Ltr., George W. Jeffs, North American Rockwell Corp., to Kenneth S. Kleinknecht, MSC, Jan. 6, 1970.

NASA issued instructions for deletion of the Apollo 20 mission from the program (see January 4). MSC was directed to take immediate action to:

7

- Stop work on LM-14 and determine its disposition.
- Delete requirements for the Apollo 20 spacesuits and portable and secondary life support systems.
- Determine disposition of CSM 115A pending a final decision as to its possible use in a second workshop mission.
- Reevaluate orbital science experiments and assignments and prepare proposed revisions.

TWX, Rocco A. Petrone, NASA Hq., to MSC, "Apollo 20 Deletion," Jan. 7, 1970.

Dale D. Myers' appointment as NASA Associate Administrator for Manned Space Flight was announced effective January 12, to succeed Dr. George E. Mueller, who had joined General Dynamics Corp. in New York City as a Vice President. Before this appointment, Myers was Vice President and General Manager of the Space Shuttle Program, North American Rockwell Corp.

12

NASA News Release 70-4, Jan. 8, 1970.

The scientific debriefing of the *Apollo 12* astronauts indicated there were areas of strong interest for which there was no data and that the data could have been provided by an Apollo lunar surface closeup stereo camera. These included three distinct kinds of soil noticed by the astronauts, strangely patterned surface in certain areas, glazings in craters, and fillets around certain rocks. To assist the Apollo 13 astronauts in making scientific judgment of targets to be documented, the following photography list was established: unexpected features, glassy features, rock-soil junction, undisturbed surface, surface patterns, rock surface, and craters.

14

Memos, Anthony J. Calio, MSC, to James A. McDivitt, MSC, "Experiment S184 on Apollo 13. Apollo Lunar Surface Close-up Photography," Jan. 14, 1970; Richard S. Johnston, MSC, to Lee R. Scherer, NASA Hq., "Close-up stereo camera utilization on Apollo 13," Jan. 27, 1970.

1970

January

16

An MSC meeting to realign the Apollo 16-19 lunar orbital science experiments recommended that the Sounding Radar Experiment, S-167, be deleted and the Lunar Electromagnetic Sounder, S-168, should be developed and flown. Scientific value for the experiments was ranked in the following descending priorities for the various scientific disciplines: geochemistry, particles and fields, imagery and geodesy, surface and subsurface profiles, and atmospheres.

Minutes, Lunar Orbital Experiments Review, Jan. 16, 1970; memo, James A. McDivitt, MSC, to Rocco A. Petrone, NASA Hq., "Lunar orbital science experiments," Jan. 21, 1970.

29

Ground rules for service module design and integration, established during recent changes in the lunar orbital science program (see January 16), were reported. The Apollo LM experiment hardware would be installed and tested at KSC. A single scientific instrument module configuration was being proposed for Apollo 16-19 with modification kits developed, as required, to install Apollo 18 and Apollo 19 experiments. An expanded Apollo LM data system would be available for Apollo 16 (spacecraft 112).

Memo, James A. McDivitt, MSC, to Rocco A. Petrone, NASA Hq., "Apollo lunar orbital science program," Jan. 29, 1970.

February

5

North American Rockwell completed an investigation, requested by NASA, of the *Apollo 12* flight anomalies associated with apparent vehicle electrostatic discharges at 36.5 and 52 seconds into the flight. The investigation indicated the most logical recommendation consistent with cost and schedule considerations to minimize or eliminate similar occurrences was for more restrictive launch rules. When atmospheric conditions exhibited electrostatic gradients in excess of several thousand volts with severe fluctuations or when heavy cloud conditions associated with frontal passages existed even in the absence of precipitation or reported spherics activities, delay of launch should be considered.

Ltr., George W. Jeffs, North American Rockwell Corp., to James A. McDivitt, MSC, Feb. 5, 1970.

6

A statement of agreements was reached between NASA Hq. and the Centers covering the requirements for a lunar roving vehicle (LRV). Appropriate portions of the agreements were being incorporated in a revised Apollo Program Specification and in Apollo Program Directive No. 4.

Memo, Rocco A. Petrone, NASA Hq., to MSFC, MSC, and KSC, "Lunar Roving Vehicle Requirements," Feb. 6, 1970.

17

MSC appointed a panel to investigate a February 13 accident at the Aerojet-General plant in Fullerton, Calif., that had damaged a lunar module descent tank beyond repair. Panel findings were reported to a review board later in the month, which recommended needed safety measures.

Ltr., O. G. Morris, MSC, to R. H. Tripp, Grumman, Feb. 17, 1970; memo for record, S. H. Simpkinson, MSC, "LM descent tank incident at Aerojet-General Corporation, California, on February 13, 1970," March 6, 1970.

In a White House release, President Nixon listed six specific objectives for the space program: continued exploration of the moon, exploration of the planets and the universe, substantial reductions in the cost of space operations, extension of man's capability to live and work in space, rapid expansion of the practical applications of space technology, and greater international cooperation in space.

Office of the Federal Register, National Archives and Records Service, *Weekly Compilation of Presidential Documents*, March 9, 1970, pp. 328-31.

1970

March

7

Wernher von Braun was sworn in as NASA Deputy Associate Administrator for Planning. He left MSFC on March 1 and was succeeded as MSFC Director by Eberhard F. M. Rees.

Astronautics and Aeronautics, 1970 (NASA SP-4015, 1972), pp. 88-89.

13

Astronaut John L. Swigert, Jr., Apollo 13 backup command module pilot, began intensive training as a replacement for Thomas K. Mattingly II. The Apollo 13 prime crew had undergone a comprehensive medical examination after German measles had been contracted by Charles M. Duke, Jr., a member of the Apollo 13 backup crew. Mattingly had not shown immunity to the rubella virus and it was feared that he might become ill during the Apollo 13 flight.

MSC Apollo 13 Mission Report (MSC-02680), September 1970.

April

6-10

Apollo 13 (AS-508) was launched from Pad A, Launch Complex 39, KSC, at 2:13 p.m. EST April 11, with astronauts James A. Lovell, Jr., John L. Swigert, Jr., and Fred W. Haise, Jr., aboard. The spacecraft and S-IVB stage entered a parking orbit with a 185.5-kilometer apogee and a 181.5-kilometer perigee. At 3:48 p.m., onboard TV was begun for five and one-half minutes. At 4:54 p.m., an S-IVB burn placed the spacecraft on a translunar trajectory, after which the CSM separated from the S-IVB and LM *Aquarius*. (The crew had named lunar module 7 *Aquarius* and CSM 109 *Odyssey*.) The CSM then hard-docked with the LM. The S-IVB auxiliary propulsion system made an evasive maneuver after CSM/LM ejection from the S-IVB at 6:14 p.m. The docking and ejection maneuvers were televised during a 72-minute period in which interior and exterior views of the spacecraft were also shown.

11-17

At 8:13 p.m. EST a 217-second S-IVB auxiliary propulsion system burn aimed the S-IVB for a lunar target point so accurately that another burn was not required. The S-IVB/IU impacted the lunar surface at 8:10 p.m. EST on April 14 at a speed of 259 meters per second. Impact was 137.1 kilometers from the *Apollo 12* seismometer. The seismic signal generated by the impact lasted 3 hours 20 minutes and was so strong that a ground command was necessary to reduce seismometer gain and keep the recording on the scale. The suprathreshold ion detector experiment, also deployed by the *Apollo 12* crew, recorded a jump in the number of ions from zero at the time of impact up to 2500 shortly thereafter and then back to a zero count. Scientists theorized that ionization had been produced by 6300 K to 10 300 K (6000°C to

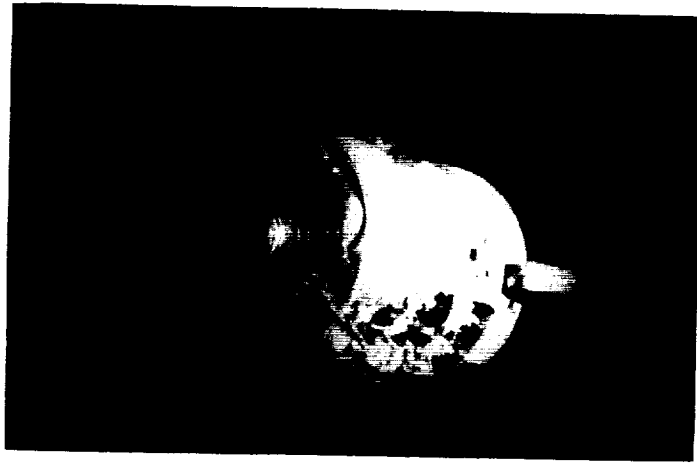

The severely damaged *Apollo 13* service module, whose oxygen tank explosion aborted the lunar landing mission, was photographed from the LM/CM after SM jettison for reentry. An entire panel had been blown off, exposing fuel cells. The interior view of the LM—after astronauts had transferred to use the emergency “lifeboat” for return to earth—shows temporary connections and apparatus rigged to use LM supplies and systems. An astronaut holds the PLSS feed water bag connected to a hose from a lunar camera. An astronaut-built “mailbox” in the background used CM lithium hydroxide canisters to purge carbon dioxide from the LM. John L. Swigert, Jr., holds a hose. Just before reentry, astronauts returned to the CM and jettisoned the LM, photographing it as they bid their lifeboat *Aquarius* farewell.

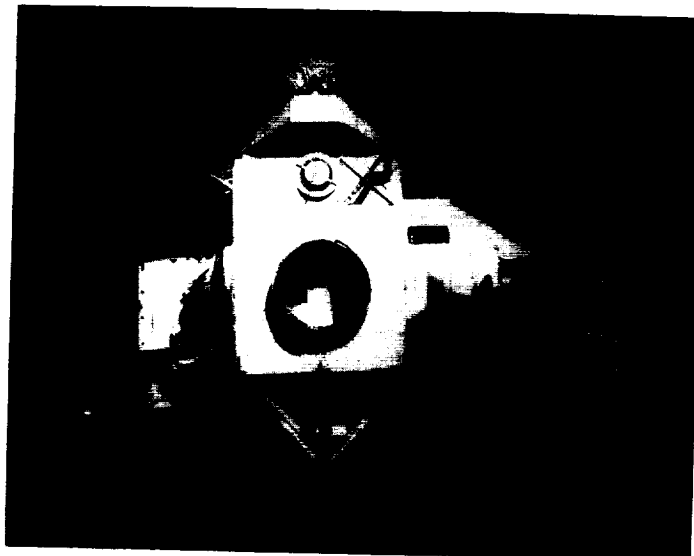

10 000°C) temperature generated by the impact or that particles had reached an altitude of 60 kilometers from the lunar surface and had been ionized by sunlight.

Meanwhile back in the CSM/LM, the crew had been performing the routine housekeeping duties associated with the period of the translunar coast. At 30:40 ground elapsed time a midcourse correction maneuver took the spacecraft off a free-return trajectory in order to control the arrival time at the moon. Ensuring proper lighting conditions at the landing site. The maneuver placed the spacecraft on the desired trajectory, on which the closest approach to the moon would be 114.9 kilometers.

At 10:08 p.m. EST April 13, the crew reported an undervoltage alarm on the CSM main bus B, rapid loss of pressure in SM oxygen tank No. 2, and dropping current in fuel cells 1 and 3 to a zero reading. The loss of oxygen and primary power in the service module required an immediate abort of the mission. The astronauts powered up the LM, powered down the CSM, and used the LM systems for power and life support. The first maneuver following the abort decision was made with the descent propulsion system to place the spacecraft back in a free-return trajectory around the moon. After the spacecraft swung around the moon, another maneuver reduced the coast time back to earth and moved the landing point from the Indian Ocean to the South Pacific.

Joy and cigar smoke. Mission Operations Control at MSC relaxes after the safe splashdown of *Apollo 13* astronauts. Lt. Gen. Samuel C. Phillips (USAF), former Apollo Program Director, is at left; MSC Director of Medical Research and Operations Charles A. Berry, third from left; NASA Administrator Thomas O. Paine, center; and NASA Deputy Director George M. Low, right.



1970

April

About four hours before reentry on April 17, the service module was jettisoned and the crew took photographs and made visual observations of the damaged area. About one hour before splashdown the command module was powered up and the lunar module was jettisoned. Parachutes were deployed as planned, and the *Odyssey* landed in the mid-Pacific 6.4 kilometers from the recovery ship U.S.S. *Iwo Jima* at 1:07 p.m. EST April 17. The astronauts were picked up by helicopter and transported to the recovery ship less than an hour after splashdown.

MSC "Apollo 13 Mission Report" (MSC-02680). Sept. 1970; MSC "Apollo 13 (AS-508) Flight Summary," undated; memos, C. M. Lee, NASA Hq., to distr., "Mission Director's Summary Report, Apollo 13," April 17, 1970; E. R. Mathews, KSC, "Apollo 13 (AS-508) Post-Launch Report," April 24, 1970.

13

MSC informed NASA Hq. that the *Apollo 12* ALSEP left on the moon in November 1969 was continuing to transmit satisfactory data. Status of experiments feeding data into the station was as follows:

The operation of the solar wind experiment was satisfactory.

During the lunar days, useful data were being received from the lunar surface magnetometer. However, during the lunar-night cycle data were not received.

Useful data were being received from the three long-period sensors of the passive seismometer experiment. The short period sensor was inoperative.

The cold cathode ion gauge power had failed.

Satisfactory data were being received from the suprathreshold ion detector.

Ltr., James A. McDivitt, MSC, to Rocco A. Petrone, NASA Hq., "Operational Status of Apollo 12 ALSEP," April 13, 1970.

April 13-

June 15

"Hey, we've got a problem here." The message from the *Apollo 13* spacecraft to Houston ground controllers at 10:08 p.m. EDT on April 13, initiated an investigation to determine the cause of an oxygen tank failure that aborted the *Apollo 13* mission. The investigation terminated on June 15, when the Review Board accident report was released by NASA at a Headquarters press conference.

The Apollo 13 Review Board was established April 17 by George M. Low, NASA Deputy Administrator, and Thomas O. Paine, NASA Administrator, who appointed the Director of Langley Research Center, Edgar M. Cortright, as Review Board Chairman. On April 21 the members of the Board were named. In addition, by separate memos of April 20, the Aerospace Safety Advisory Panel was requested to review the procedures and findings of the Board and the Associate Administrator for Manned Space Flight was directed to provide records, data, and technical support as requested by the Board. The investigation indicated the accident was caused by a combination of mistakes and a somewhat deficient design. The following sequence of events led to the accident:

1970

April

a. After assembly and acceptance testing, the oxygen tank no. 2 that flew on *Apollo 13* was shipped from Beech Aircraft Corp. to North American Rockwell (NR) in apparently satisfactory condition.

b. However, the tank contained two inadequate protective thermostatic switches on the heater assembly, and they subsequently failed during ground test operations at Kennedy Space Center (KSC).

c. In addition, the tank probably contained a loosely fitting fill tube assembly. This assembly was probably displaced during subsequent handling, which included an incident at the prime contractor's plant in which the tank was jarred.

d. In itself, the displaced fill tube assembly was not particularly serious, but it led to improvised detanking procedures at KSC, which "almost certainly set the stage for the accident."

e. Although Beech had not met any problem in detanking during acceptance tests, it was not possible to detank oxygen tank no. 2 using normal procedures at KSC. Tests and analyses indicate that the problem was gas leakage through the displaced fill tube assembly.

f. The special detanking procedures at KSC subjected the tank to an extended period of heater operation and pressure cycling. "These procedures had not been used before, and the tank had not been qualified by test for the conditions experienced. However, the procedures did not violate the specifications which governed the operation of the heaters at KSC."

g. In reviewing these procedures before the flight, officials of NASA, NR, and Beech did not recognize the possibility of damage from overheating. Many were not aware of the extended heater operation. In any event, adequate thermostatic switches might have been expected to protect the tank.

h. A number of factors contributed to the presence of inadequate thermostatic switches in the heater assembly. The original 1962 specifications from NR to Beech Aircraft Corp. for the tank and heater assembly specified the use of 28-volt, direct-current power, which was used in the spacecraft. In 1965, NR issued a revised specification that stated the heaters should use a 65-volt dc power supply for tank pressurization; this was the power supply used at KSC to reduce pressurization time. Beech ordered switches for the Block II tanks but did not change the switch specifications to be compatible with 65-volt dc.

i. The thermostatic switch discrepancy was not detected by NASA, NR, or Beech in their review of documentation, nor did tests identify the incompatibility of the switches with the ground support equipment (GSE) at KSC, "since neither qualification nor acceptance testing required switch cycling under load as should have been done. It was a serious oversight in which all parties shared."

j. The thermostatic switches could accommodate the 65-volt dc during tank pressurization because they normally remained cool and closed. However, they could not open without damage with 65 volt dc power applied. They were not required to open until the special detanking. During this procedure, as the switches started to open when they reached their upper

1970

April

temperature limit, they were welded permanently closed by the resulting arc and were rendered inoperative as protective thermostats.

k. Failure of the thermostatic switches to open could have been detected at KSC if switch operation had been checked by observing heater current readings on the oxygen tank heater control panel. Although not recognized at the time, the tank temperature readings indicated that the heaters had reached their temperature limit "and switch opening should have been expected."

l. Subsequent tests showed that failure of the thermostatic switches probably permitted the temperature of the heater tube assembly to reach about 1000°F [810 K] in spots during the continuous eight-hour period of heater operation. Such heating had been shown by tests to damage severely the Teflon insulation on the fan motor wires near the heater assembly. "From that time on, including pad occupancy, the oxygen tank no. 2 was in a hazardous condition when filled with oxygen and electrically powered."

m. Nearly 56 hours into the mission, the fan motor wiring, possibly moved by the fan stirring, short-circuited and ignited its insulation. Combustion in the oxygen tank "probably overheated and failed the wiring conduit where it entered the tank, and possibly a portion of the tank itself."

n. The rapid expulsion of high-pressure oxygen which followed, "possibly augmented by combustion of insulation in the space surrounding the tank, blew off the outer panel to bay 4 of the SM, caused a leak in the high-pressure system of oxygen tank no. 1, damaged the high-gain antenna, caused other miscellaneous damage, and aborted the mission."

Based on the findings of the Board, a number of recommendations were made to preclude similar accidents in future space flights:

1. The cryogenic oxygen storage system in the service module should be modified to:

a. Remove from contact with the oxygen all wiring and unsealed motors that could potentially short-circuit and ignite adjacent materials; or otherwise ensure against an electrically induced fire in the tank.

b. Minimize the use of Teflon, aluminum, and other relatively combustible materials in the presence of the oxygen and potential ignition sources.

2. The modified cryogenic oxygen storage system should be subjected to a rigorous requalification program, including careful attention to potential operational problems.

3. The warning systems on the Apollo spacecraft and in the Mission Control Center should be carefully reviewed and modified where appropriate, with specific attention to:

a. Increasing the differential between master alarm trip levels and expected normal operating ranges to avoid unnecessary alarms.

1970

April

b. Changing the caution and warning system logic to prevent an out-of-limits alarm from blocking another alarm if a second quantity in the same subsystem went out of limits.

c. Establishing a second level of limit sensing in Mission Control on critical quantities, with a visual or audible alarm that could not be easily overlooked.

d. Providing independent talk-back indicators for each of the six fuel cell reactant valves plus a master alarm when any valve closed.

4. Consumables and emergency equipment in the LM and the CM should be reviewed to determine whether steps should be taken to enhance their potential for use in a 'lifeboat' mode.

5. MSC should complete the special tests and analyses under way to understand more completely the details of the *Apollo 13* accident. In addition, the lunar module power system anomalies should receive careful attention. Other NASA Centers should continue support to MSC in the areas of analysis and test.

6. Whenever significant anomalies occurred in critical subsystems during final preparation for launch, standard procedures should require a presentation of all prior anomalies on that particular piece of equipment, including those which have previously been corrected or explained. Critical decisions on flightworthiness should require the full participation of an expert "intimately familiar with the details of that subsystem."

7. NASA should thoroughly reexamine all its spacecraft, launch vehicle, and ground systems containing high-density oxygen or other strong oxidizers, to identify and evaluate potential combustion hazards in the light of information developed in this investigation.

8. NASA should conduct additional research on materials compatibility, ignition, and combustion in strong oxidizers at various gravity levels and on the characteristics of supercritical fluids. Where appropriate, new NASA design standards should be developed.

9. MSC should reassess all Apollo spacecraft subsystems, and the engineering organizations responsible for them at MSC and at its prime contractors, to ensure adequate understanding and control of the engineering and manufacturing details at the subcontractor and vendor level. "Where necessary, organizational elements should be strengthened and in-depth reviews conducted on selected subsystems with emphasis on soundness of design, quality of manufacturing, adequacy of test, and operational experience."

Memos, Low and Paine to Cortright, "Establishment of Apollo 13 Review Board," April 17, 1970; Low and Paine to Cortright, "Membership of Apollo 13 Review Board," April 21, 1970; Low and Paine to Chairman, Aerospace Safety Advisory Panel Charles D. Harrington, "Review of Procedures and Findings of Apollo 13 Review Board," April 20, 1970; Low and Paine to Dale D. Myers, NASA Hq., "Apollo 13 Review," April 20, 1970; ltr., Cortright to Paine, June 15, 1970; House Committee on Science and Astronautics, *The Apollo 13 Accident: Hearings*, 91st Cong., 2d sess., June 16, 1970, pp. 234-36, 273-74.

1970

April

19

To support the Apollo 13 Review Board, an MSC Apollo 13 Investigation Team, headed by Scott H. Simpkinson, was established with the following panels: spacecraft incident investigation, flight crew observations, flight operations and network; photograph handling, processing, and cataloging; corrective action study and implementation for the CSM, LM, and government-furnished equipment; related system evaluation; reaction processes in high-pressure fluid systems; high-pressure oxygen system survey; public affairs; and administration, communications, and procurement.

Memos, James A. McDivitt, MSC, to Apollo 13 Investigation Team, "Apollo 13 Investigation Team organization," April 19, 1970; Owen G. Morris, MSC, to Scott H. Simpkinson, "Apollo 13 Investigation Team organization," April 20, 1970.

June

26

NASA Hq. and Center actions were initiated on recommendations of the Apollo 13 Review Board. The Associate Administrator for Space Science and Applications would take specific action on recommendations 6, 7, and 9 of the report as they applied to spacecraft, launch vehicles, aircraft, ground systems and laboratories under OSSA jurisdiction. Lewis Research Center

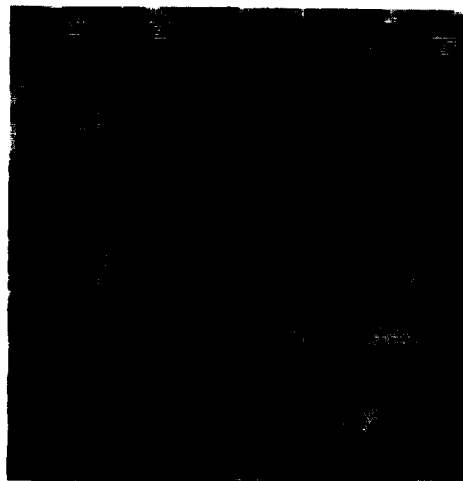

An interior view of the Space Environment Simulation Laboratory at MSC shows Chamber A with the door open in the background and an Apollo spacecraft mockup inside a work stand. In the high-angle photo inside Chamber A, three suited astronauts prepare to enter Apollo spacecraft 2TV-1 for a run-through before an eight-day manned thermal vacuum test. The astronauts are Joe H. Engle, left, Vance D. Brand, center, and Joseph P. Kerwin.

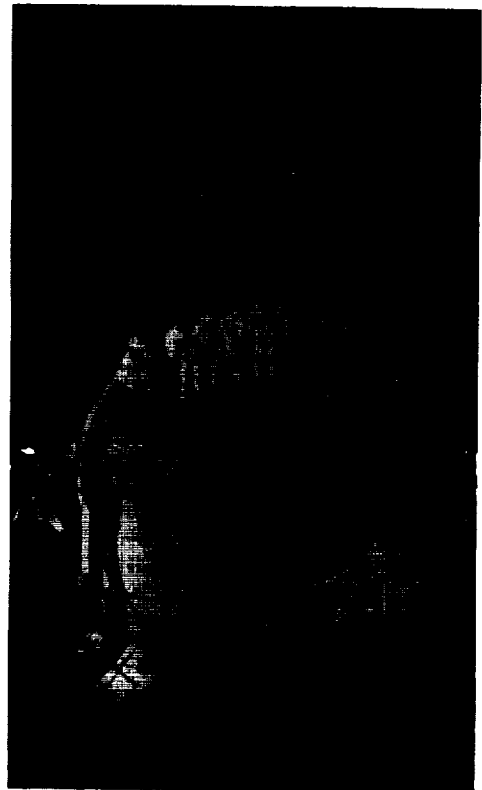

was directed to conduct a comprehensive review of oxygen-handling practices in NASA programs. The Aerospace Safety Research and Data Institute was already conducting studies on oxygen handling in aerospace programs. Other Centers were taking action on Board recommendations as applicable. (See July 16 entry.)

1970**June**

Memos, George M. Low, NASA Hq., to Associate Administrator for Space Science and Applications, "Recommendations of the Apollo 13 Review Board," June 26, 1970; Low to Director, Lewis Research Center, "Expansion of ASRDI Oxygen Systems Review," June 26, 1970; T. O. Paine, NASA Hq., to Director, Lewis Research Center, "Review of Oxygen Handling in Aerospace Programs to be Conducted by the Aerospace Safety Research and Data Institute (ASRDI)," May 19, 1970; Bruce T. Lundin, Lewis Research Center to Deputy Administrator, "Proposed oxygen handling program," July 14, 1970; Deputy Associate Administrator for Space Science and Applications (Engineering) to distr., "Recommendations of the Apollo 13 Review Board," Aug. 5, 1970.

Efforts of MSC personnel that had been redirected to support the *Apollo 13* investigation would again be concentrated on the Apollo-experience-reporting project in an effort to attain a publication date of November 1, 1970.

July**14**

Memo, Scott H. Simpkinson, MSC, to distr., "Apollo experience reporting," July 14, 1970.

MSC moved to reassess all Apollo spacecraft subsystems and the engineering organizations responsible for them at MSC and its prime contractors, in response to Apollo 13 Review Board recommendation 9 (see April 13–June 15).

16

Memo, James A. McDivitt, MSC, to distr., "Apollo 13 Review Board Report—Recommendation #9," July 16, 1970; extract from recommendation 9 of the Apollo 13 Review Board Report.

During the anniversary of *Apollo 11*, NASA Administrator Thomas O. Paine said: "The success of Apollo 11 marked the beginning of a new and important phase of mankind—not just the triumphant end of a mission. The mission was a voyage of discovery, and an important part of the discovery was the revelation of the infinite human potential for achievement as an endless new frontier was opened for future generations.

17

"Our remarkable progress in the first dozen years of the space age demonstrates that no dreams are impossible of realization, that the prospects for progress and human betterment here on earth as well as in space are limitless. And you may be sure that despite changing program directions, NASA will continue to play an exciting and vigorous role in the avant-garde of human progress."

Paine, Message to NASA coworkers, July 17, 1970.

North American Rockwell announced that William B. Bergen, who had been serving as president of North American's Space Division, would become a corporate vice president with the title Group Vice President-Aerospace and Systems. This was one of a number of key organizational

August**7**

Astronauts Edgar D. Mitchell, left, and Alan B. Shepard, Jr., participate in lunar surface simulation at Kennedy Space Center. Both wear extravehicular mobility units as they check out the mobile (or modular) equipment transporter they will use on the moon during the Apollo 14 mission.

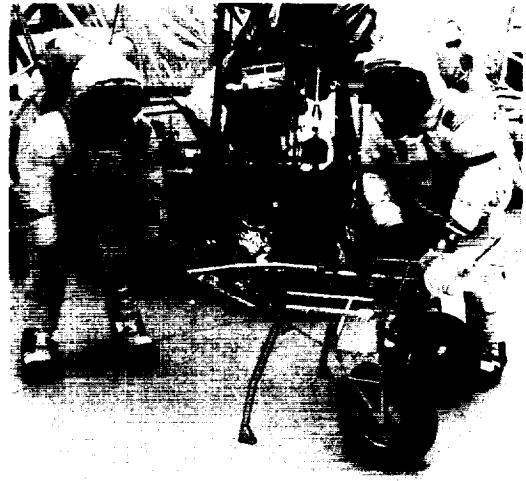

1970
August

steps taken since January to improve and strengthen the North American management structure in response to significant changes that had occurred in the aerospace environment.

Ltr., Robert Anderson, North American Rockwell Corp., to Robert R. Gilruth, MSC, Aug. 11, 1970.

September
2

NASA was canceling Apollo missions 15 and 19 because of congressional cuts in FY 1971 NASA appropriations, Administrator Thomas O. Paine announced in a Washington news conference. Remaining missions would be designated Apollo 14 through 17. The Apollo budget would be reduced by \$42.1 million, to \$914.4 million—within total NASA \$3.27 billion.

"Statement by Dr. Thomas O. Paine," Sept. 2, 1970; *Astronauts and Aeronautics, 1970* (NASA SP-4015, 1972), pp. 248, 257, 284-85.

11

Modifications were made in MSFC's lunar roving vehicle simulator and the static mockup to eliminate extreme arm and hand fatigue felt by a flight crew member and other test subjects after driving 10 to 15 minutes in LRV simulator evaluation tests. A T-shaped handle was added to the pistol grip; a parking-brake release and a reduced brake-travel distance were incorporated; and a mechanical reverse lockout was added.

Memo, James A. McDivitt, MSC, to Richard G. Smith, MSFC, "Lunar roving vehicle hand controller," Sept. 11, 1970.

November
24

MSC Director Robert R. Gilruth reported MSC actions on the Apollo 13 Review Board recommendations (see April 13-June 15), including:

- Fan motors had been removed from oxygen storage tanks in the service modules; the electrical leads had been encased in stainless steel sheaths with hermetically sealed headers and had been shielded from contact with the remaining Teflon parts.

- The modified cryogenic oxygen storage system had been subjected to a comprehensive recertification program developed in close coordination by

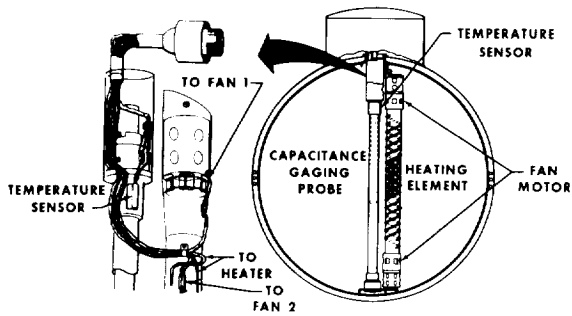

Apollo 13's service module oxygen tank, left. Redesigned oxygen tank below.

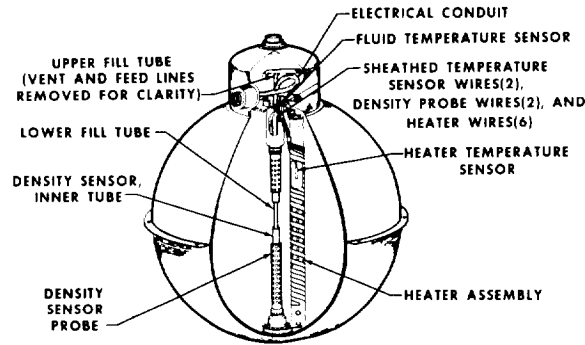

North American Rockwell, Beech Aircraft Corp., and NASA. Requirements were founded on environmental as well as operational factors necessary to prove design capability.

1970

November

- No major changes had been made in the caution and warning system.
- The LM and CSM consumables and emergency equipment had been reviewed to determine any design changes required to provide a safe return from lunar orbit in the event of a service module cryogenic-oxygen-supply loss. Three design changes were made in the CSM related to the oxygen tanks, an LM descent battery, and a water storage system in the CM.

- MSC had made special tests and analyses to understand the *Apollo 13* accident better. The testing had reaffirmed the conclusions reached by the Apollo 13 Review Board.

- Significant anomalies in critical subsystems during final preparation for launch would be analyzed and resolved with authorized and documented corrective action in much the same manner as employed during the missions. An Apollo Program Directive for identification and resolution of significant failures and anomalies had been issued.

- A thorough reexamination of all spacecraft, launch vehicle, and ground systems containing high-density oxygen and other strong oxidizers was being made to identify and evaluate potential combustion hazards.

- Additional research was being conducted on materials compatibility, ignition, and combustion in strong oxidizers at various gravity levels and on the characteristics of supercritical fluids. Arc-ignition tests of the Apollo 14

1970
November

oxygen-storage-system materials in both normal and overstressed modes indicated a positive margin of safety.

- MSC had organized a system-by-system task team effort and made comprehensive reassessments of each subsystem. Design and qualification of each subsystem was reaffirmed as adequate for current ground test and mission requirements with the exception of a heatshield blowout plug for dumping reaction-control-subsystem propellant for launch aborts.

Ltr., Gilruth to Edgar M. Cortright, LaRC, Nov. 24, 1970.

25

George M. Low, Acting NASA Administrator, discussed the significance of unmanned lunar probes *Luna XVI* and *XVII* launched by the U.S.S.R. September 12 and November 10. *Luna XVI* had brought lunar samples back to earth and *Luna XVII* had landed an unmanned Lunokhod roving vehicle on the moon's surface. Low stated in a letter to Chairman Clinton P. Anderson of the Senate Committee on Aeronautical and Space Sciences that while the two launches were impressive their contributions to science and technology were relatively minor. Low suggested that the main lesson to be learned from the two launches specifically and the U.S. and U.S.S.R. space programs in general was that while the Soviet launch rate was increasing that of the United States was decreasing. These trends in the two countries' space programs should be a cause of concern if the United States was interested in maintaining a position of leadership in space.

Ltr., Dale D. Myers, NASA Hq., to Robert R. Gilruth, MSC, Dec. 16, 1970; *Congressional Record-Senate*, Nov. 30, 1970, pp. S19001-02.

1971
January
18

NASA was considering several methods for providing real-time television coverage of lunar surface activities with scientific commentary to the news media during future Apollo flights. A recommended approach would place



Astronaut Shepard stands near a lunar landing training vehicle at Ellington Field, Texas, before a test flight December 14, 1970, preparing for his January 1971 role on Apollo 14.

scientific personnel from within NASA, including Apollo Program principal investigators, in the MSC news center briefing room with a panel representing the news media. The scientific personnel would supplement the normal air-to-ground communications, public affairs commentary, and TV transmissions from the moon with spontaneous commentary on surface activities in progress.

1971
January

Memo, James A. McDivitt, MSC, to Rocco A. Petrone, NASA Hq., "Media coverage of Apollo 12 and 14 experiments," Jan. 18, 1971.

The space vehicle for the Apollo 14 mission was determined ready for launch on January 31. The Flight Readiness Review had been held at KSC on December 17, 1970; all required action and open work had been completed; and the Pre-Liftoff Readiness Review had been favorably completed January 29.

29

Memo, Rocco A. Petrone, NASA Hq., to Apollo 14 Flight Readiness Review Record, "Confirmation of Flight Readiness for the Apollo 14 Mission," Jan. 29, 1971.

The *Apollo 14* (AS-509) mission—manned by astronauts Alan B. Shepard, Jr., Stuart A. Roosa, and Edgar D. Mitchell—was launched from Pad A, Launch Complex 39, KSC, at 4:03 p.m. EST January 31 on a Saturn V launch vehicle. A 40-minute hold had been ordered 8 minutes before scheduled launch time because of unsatisfactory weather conditions, the first such delay in the Apollo program. Activities during earth orbit and translunar injection were similar to those of the previous lunar landing missions. However, during transposition and docking, CSM 110 *Kitty Hawk* had difficulty docking with LM-8 *Antares*. A hard dock was achieved on the sixth attempt at 9:00 p.m. EST, 1 hour 54 minutes later than planned. Other aspects of the translunar journey were normal and proceeded according to flight plan. A crew inspection of the probe and docking mechanism was televised during the coast toward the moon. The crew and ground personnel were unable to determine why the CSM and LM had failed to dock properly, but there was no indication that the systems would not work when used later in the flight.

January 31–
February 9

Apollo 14 entered lunar orbit at 1:55 a.m. EST on February 4. At 2:41 a.m. the separated S-IVB stage and instrument unit struck the lunar surface 174 kilometers southeast of the planned impact point. The *Apollo 12* seismometer, left on the moon in November 1969, registered the impact and continued to record vibrations for two hours.

After rechecking the systems in the LM, astronauts Shepard and Mitchell separated the LM from the CSM and descended to the lunar surface. The *Antares* landed on Fra Mauro at 4:17 a.m. EST February 5, 9 to 18 meters short of the planned landing point. The first EVA began at 9:53 a.m., after intermittent communications problems in the portable life support system had caused a 49-minute delay. The two astronauts collected a 19.5-kilogram contingency sample; deployed the TV, S-band antenna, American

1971

January

flag, and Solar Wind Composition experiment; photographed the LM, lunar surface, and experiments; deployed the Apollo lunar surface experiments package 152 meters west of the LM and the laser-ranging retroreflector 30 meters west of the ALSEP; and conducted an active seismic experiment, firing 13 thumper shots into the lunar surface.

A second EVA period began at 3:11 a.m. EST February 6. The two astronauts loaded the mobile equipment transporter (MET)—used for the first time—with photographic equipment, tools, and a lunar portable magnetometer. They made a geology traverse toward the rim of Cone Crater, collecting samples on the way. On their return, they adjusted the alignment of the ALSEP central station antenna in an effort to strengthen the signal received by the Manned Space Flight Network ground stations back on earth.

Just before reentering the LM, astronaut Shepard dropped a golf ball onto the lunar surface and on the third swing drove the ball 366 meters. The second EVA had lasted 4 hours 35 minutes, making a total EVA time for the mission of 9 hours 24 minutes. The *Antares* lifted off the moon with 43 kilograms of lunar samples at 1:48 p.m. EST February 6.

Meanwhile astronaut Roosa, orbiting the moon in the CSM, took astronomy and lunar photos, including photos of the proposed Descartes landing site for Apollo 16.

Ascent of the LM from the lunar surface, rendezvous, and docking with the CSM in orbit were performed as planned, with docking at 3:36 p.m. EST February 6. TV coverage of the rendezvous and docking maneuver was excellent. The two astronauts transferred from the LM to the CSM with samples, equipment, and film. The LM ascent stage was then jettisoned and intentionally crashed on the moon's surface at 7:46 p.m. The impact was recorded by the *Apollo 12* and *Apollo 14* ALSEPs.

The spacecraft was placed on its trajectory toward earth during the 34th lunar revolution. During transearth coast, four inflight technical demonstrations of equipment and processes in zero gravity were performed.

The CM and SM separated, the parachutes deployed, and other reentry events went as planned, and the *Kitty Hawk* splashed down in mid-Pacific at 4:05 p.m. EST February 9 about 7 kilometers from the recovery ship U.S.S. *New Orleans*. The *Apollo 14* crew returned to Houston on February 12, where they remained in quarantine until February 26.

All primary mission objectives had been met (see Appendix 5). The mission had lasted 216 hours 40 minutes and was marked by the following achievements:

- Third manned lunar landing mission and return.
- Use of mobile equipment transporter (MET).
- Payload of 32 500 kilograms placed in lunar orbit.
- Distance of 3.3 kilometers traversed on lunar surface.

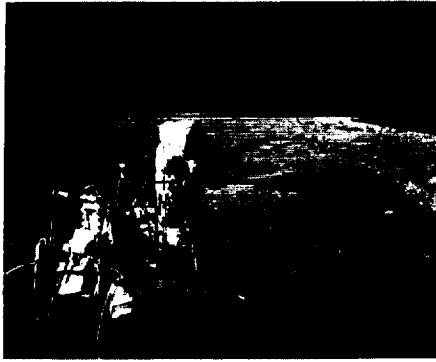
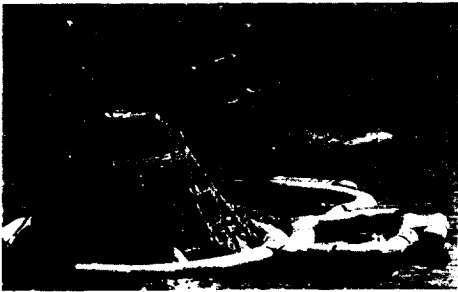

Tracks of the modular equipment transporter lead back across the lunar surface to the distant LM *Antares* during *Apollo 14* EVA. Also during EVA, Shepard assembles hand tools from the transporter. The large boulder was found by Shepard and Mitchell during the excursion. In recovery operations after splashdown, CM pilot Roosa is hoisted up to one of the recovery helicopters.

- Payload of 43.5 kilograms returned from the lunar surface.
- Lunar surface stay time of 33 hours.
- Lunar surface EVA of 9 hours 47 minutes.
- Use of shortened rendezvous technique.
- Service propulsion system orbit insertion.
- Active seismic experiment.
- Inflight technical demonstrations.
- Extensive orbital science period during CSM solo operations.

MSC, "Apollo 14 (AS-509) Flight Summary," undated; MSC, "Apollo 14 Mission Report" (MSC-04112), April 1971; NASA OMSF, "Manned Space Flight Weekly Report—February 16, 1971"; TWX, F. A. Speer, MSFC, to C. M. Lee, NASA Hq., "Apollo 14 (AS-509) HOSC Report," Jan. 31, 1971; ltr., Chester M. Lee, NASA Hq., "Mission Director's Summary Report, Apollo 14," Feb. 9, 1971; NASA Hq., *Apollo 14 Preliminary Science Report* (NASA SP-272, 1971).

MSC requested removal of sharp corners from the lunar roving vehicle (LRV) seat. During a recent series of LRV/EMU (extravehicular mobility unit) tests, a nicking or tearing of the portable life support system thermal cover had been discovered. Observation revealed that the thermal cover was

1971

January

February

22



1971
February

Apollo 15 astronauts James B. Irwin, left, Alfred M. Worden, and David R. Scott display the experiments and equipment to be loaded into their LM for its July 1971 mission to the moon.

contacting sharp corners on the LRV seats, when the test subject entered and left the vehicle.

Ltr., James A. McDivitt, MSC, to Richard G. Smith, MSFC, "Sharp corners on current lunar roving vehicle design," Feb. 22, 1971.

March
1

Because of difficulties during the past several months in developing and qualifying an automatic deployment system for the lunar roving vehicle, the automatic system was abandoned in favor of a manual system. Boeing was directed to stop all further effort on the automatic system.

Ltr., Richard G. Smith, MSFC, to Rocco A. Petrone, NASA Hq., "LRV Manual Deployment System," March 1, 1971.

10

Action was initiated to determine the feasibility of providing photographic coverage of a lunar eclipse from the lunar surface or the CSM during the Apollo 15 mission. The eclipse would occur on August 6, three or four days after the scheduled Apollo 15 mission lunar surface liftoff.

TWX, Rocco A. Petrone, NASA Hq., to James A. McDivitt, MSC, "Lunar eclipse during Apollo 15 mission," March 10, 1971.

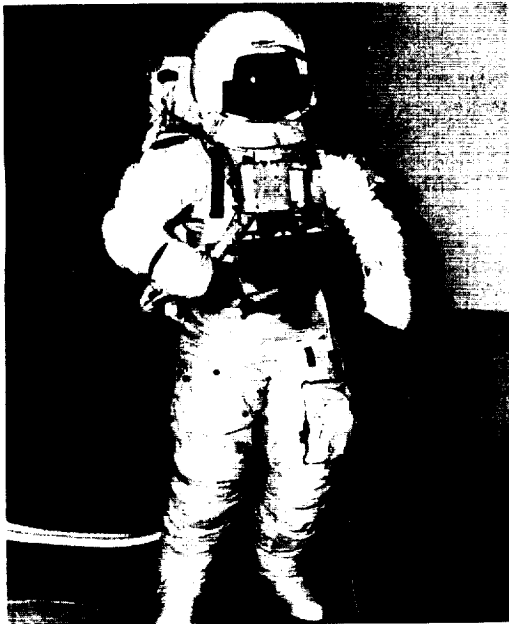

The improved design of the extravehicular mobility unit (EMU) to be used by astronauts on the moon for Apollo 15 and subsequent missions permitted increased lunar surface EVA periods, extended range of operations, and greater mobility than previous units. Shown are the pressure garment assembly with thermal overlay, the portable life support system on the back with oxygen purge system on top, the remote control unit fitting the chest, with Goertz lunar surface camera attached, and the lunar extravehicular visor assembly. Lunar surface boots are not shown.

Acting NASA Administrator George M. Low discontinued the quarantine for future Apollo flights to the moon beginning with the Apollo 15 mission. The decision was based on a recommendation of the Interagency Committee on Back Contamination (ICBC). The ICBC would continue as an active body, however, at least until the results of the last Apollo lunar mission were reviewed. Biomedical characterization of returned lunar samples would also be continued.

Low announcement, "Decision to Terminate Quarantine under NMI 1052.90 (Attachment A, Change 1, 2)," April 26, 1971; ltr., Dale D. Myers, NASA Hq., to MSC Director, "Decision to Terminate Quarantine," May 10, 1971; TWX, J. W. Humphreys, NASA Hq., "Discontinuance of Lunar Quarantine," April 28, 1971.

James C. Fletcher was sworn in as NASA Administrator at a White House ceremony. President Nixon had nominated him for the position on March 1, and the Senate had confirmed the nomination on March 11. George M. Low, NASA Deputy Administrator, had been Acting Administrator since the resignation of Administrator Thomas O. Paine on September 15, 1970.

Astronautics and Aeronautics, 1971 (NASA SP-4018, 1972), pp. 56-57, 59, 68, 69, 72, 114.

Lee B. James, Director of Program Management at MSFC, would leave for a position in the academic community effective May 31, MSFC announced. On June 1, J. T. Shepherd would assume the duties as Acting Director, Program Management. James had been active in the space program since 1947.

MSFC Key Personnel Announcement, April 30, 1971; ltr., Eberhard F. M. Rees, MSFC, to Robert R. Gilruth, MSC, May 3, 1971.

1971

April

26

27

30

1971

May

5

The Apollo Site Selection Board selected Descartes as the Apollo 16 site. However, after the selection, a discussion began as to whether the Kant or Descartes region would be the better choice. NASA finally decided to go with the original selection of the Board: Descartes would be the prime Apollo 16 site.

Ltr., Lee R. Scherer, NASA Hq., to distr., "Apollo 16 and 17 Site Selection Discussions," May 5, 1971; TWX, Rocco A. Petrone, NASA Hq., to James A. McDivitt, MSC, et al., "Apollo 16 Landing Site," June 11, 1971.

13

NASA was considering a plan for obtaining contamination measurements on the remaining Apollo flights for use in Skylab planning. The plan required photography on Apollo 15 of liquid dumps, limited magnitude starfield, and window deposition photography. Apollo 16 and 17 would carry instrumentation to measure cloud intensity and effects, deposits and their effects, critical surfaces, particle count, surface charge potential, and pressure.

TWX, Leland F. Belew, MSFC, to William C. Schneider and John H. Disher, NASA Hq., Kenneth S. Kleinknecht, James A. McDivitt, and Ronald W. Kubicki, MSC, "Contamination Measurements on Apollo," May 13, 1971; memo, Leland F. Belew, MSFC, to ASPO and Skylab Managers, MSC, "Background and Justification for Apollo 16 Skylab Data Request," Sept. 10, 1971.



Wernher von Braun, Deputy Associate Administrator of NASA, examines the camera to be mounted on the lunar roving vehicle, shown folded for storage in the LM for its trip to the moon. The camera would be operated by astronauts, or by ground command from Mission Control in Houston during lunar traverses. It would also be used to show the astronauts when they left the Rover and to show the LM ascent-stage liftoff from the moon.

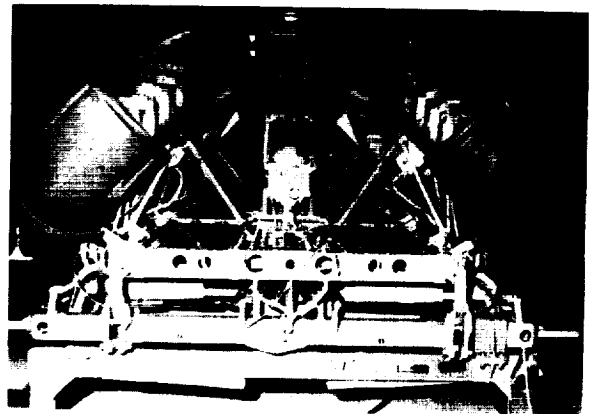

PART III: MAN CIRCLES THE MOON, LANDS, EXPLORES

Apollo 15 (AS-510) with astronauts David R. Scott, Alfred M. Worden, and James B. Irwin aboard was launched from Pad A, Launch Complex 39, KSC, at 9:34 a.m. EDT July 26. The spacecraft and S-IVB combination was placed in an earth parking orbit 11 minutes 44 seconds after liftoff. Activities during earth orbit and translunar injection (insertion into the trajectory for

1971

July 26-

August 7

Apollo 15 astronaut David Scott sits on the Rover awaiting his partner James Irwin for the return to the LM *Falcon* with samples of rocks and soil. The view of a portion of the Hadley-Apennine landing site shows the 4500-meter-high Mount Hadley on the left, on which crewmen noted a layering feature.

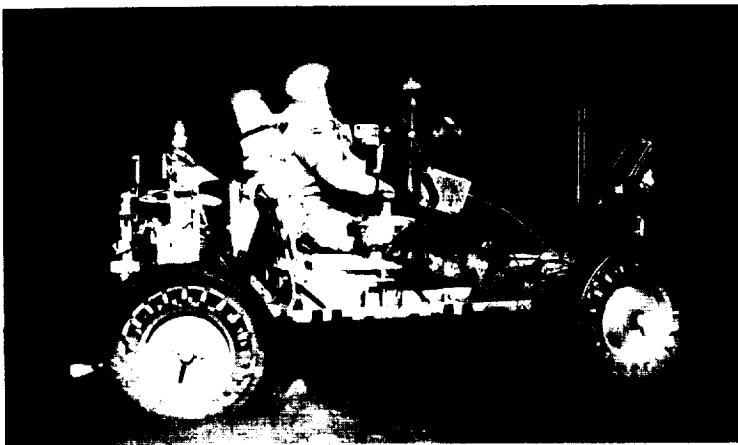

1971
July

the moon) were similar to those of previous lunar landing missions. Translunar injection was at about 12:30 p.m., with separation of the CSM from the LM/S-IVB/IU at 12:56 p.m. At 1:08 p.m., onboard color TV showed the docking of the CSM with the LM.

S-IVB auxiliary propulsion system burns sent the S-IVB/IU stages toward the moon, where they impacted the lunar surface at 4:59 p.m. EDT July 29. The point of impact was 188 kilometers northeast of the *Apollo 14* landing site and 355 kilometers northeast of the *Apollo 12* site. The impact was detected by both the *Apollo 12* and *Apollo 14* seismometers, left on the moon in November 1969 and February 1971.

After the translunar coast, during which TV pictures of the CSM and LM interiors were shown and the LM communications and other systems were checked, *Apollo 15* entered lunar orbit at 4:06 p.m. EDT July 29.

The LM-10 *Falcon*, with astronauts Scott and Irwin aboard, undocked and separated from the *Endeavor* (CSM 112) with astronaut Worden aboard. At 6:16 p.m. EDT July 30, the *Falcon* landed in the Hadley-Apennine region of the moon 600 meters north-northwest of the proposed target. About two hours later, following cabin depressurization, Scott performed a 33-minute standup EVA in the upper hatch of the LM, during which he described and photographed the landing site.

The first crew EVA on the lunar surface began at 9:04 a.m. July 31. The crew collected and stowed a contingency sample, unpacked the ALSEP and other experiments, and prepared the lunar roving vehicle (LRV) for operations. Some problems were encountered in the deployment and checkout of the LRV, used for the first time, but they were quickly resolved. The first EVA traverse was to the Apennine mountain front, after which the ALSEP was deployed and activated, and one probe of a Heat Flow experiment was emplaced. A second probe was not emplaced until EVA-2 because of drilling difficulties. The first EVA lasted 6 hours 33 minutes.

At 7:49 a.m. EDT August 1, the second EVA began. The astronauts made a maintenance check on the LRV and then began the second planned traverse of the mission. On completion of the traverse, Scott and Irwin completed the placement of heat flow experiment probes, collected a core sample, and deployed the American flag. They then stowed the sample container and the film in the LM, completing a second EVA of 7 hours 12 minutes.

The third EVA began at 4:52 a.m. August 2, included another traverse, and ended 4 hours 50 minutes later, for a total *Apollo 15* lunar surface EVA time of 18 hours 35 minutes.

While the lunar module was on the moon, astronaut Worden completed 34 lunar orbits in the CSM operating scientific instrument module experiments and cameras to obtain data concerning the lunar surface and environment. X-ray spectrometer data indicated richer abundance of aluminum

1971

July

in the highlands, especially on the far side, but greater concentrations of magnesium in the maria.

Liftoff of the ascent stage of the LM, the first one to be televised, occurred at 1:11 p.m. EDT August 2. About two hours later the LM and CSM rendezvoused and docked, and film, equipment, and 77 kilograms of lunar samples were transferred from the LM to the CSM. The ascent stage was jettisoned and hit the lunar surface at 11:04 p.m. EDT August 2. Its impact was recorded by the *Apollo 12*, *Apollo 14*, and *Apollo 15* seismometers, left on the moon during those missions. Before leaving the lunar orbit, the spacecraft deployed a subsatellite, at 4:13 p.m. August 4, in an orbit of 141.3 by 102 kilometers. The satellite would measure interplanetary and earth magnetic fields near the moon. It also carried charged-particle sensors and equipment to detect variations in lunar gravity caused by mascons (mass concentrations).

A transearth injection maneuver at 5:23 p.m. August 4 put the CSM on an earth trajectory. During the transearth coast, astronaut Worden performed an inflight EVA beginning at 11:32 a.m. August 5 and lasting for 38 minutes 12 seconds. He made three trips to the scientific instrument module (SIM) bay of the SM, twice to retrieve cassettes and once to observe the condition of the instruments in the SIM bay.

Orbiting the moon, the *Apollo 15* CSM *Endeavor* exposes its scientific instrument module bay with instruments gathering lunar data. The solar corona just beyond the lunar horizon was photographed from the CSM about one minute before sunrise July 31, 1971. Three series of photos—man's first view of this part of the sun's light—were made by astronaut Alfred Worden during his solo flight, while his fellow crewmen explored the surface below. The bright object on the opposite side of the frame is the planet Mercury. The bright star near the center is Regulus, and smaller stars form the head of the constellation Leo.

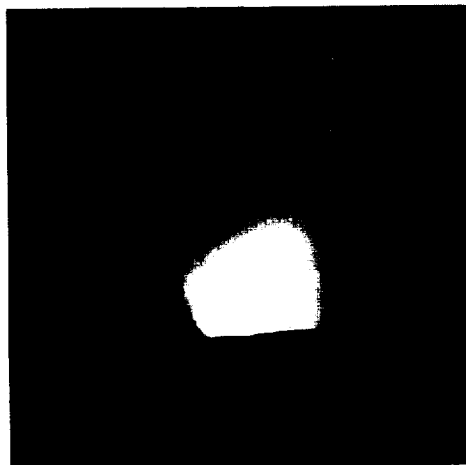

1971
July CM and SM separation, parachute deployment, and other reentry events went as planned, but one of the three main parachutes failed, causing a hard but safe landing. Splashdown—at 4:47 p.m. EDT August 7, after 12 days 7 hours 12 minutes from launch—was 530 kilometers north of Hawaii and 10 kilometers from the recovery ship U.S.S. *Okinawa*. The astronauts were carried to the ship by helicopter, and the CM was retrieved and placed on board. All primary mission objectives had been achieved (see Appendix 5).

MSC, "Apollo 15 Mission Report" (MSC-05161), December 1971; MSC, "Apollo 15 (AS-510) Flight Summary," undated; TWX, H. F. Kurtz, MSFC, to C. M. Lee, NASA Hq., "Apollo 15 (AS-510) HOSC Report," July 26, 1971; MSFC, "Saturn Evaluation Bulletin," No. 1, 2, and 3, Aug. 3, 13, 27, 1971; Ltr., Lee, "Mission Director's Summary Report, Apollo 15," Aug. 7, 1971; KSC, "Apollo 15 Post-Launch Report," Aug. 12, 1971.

October
6-7 Major items of discussion during the Manned Space Flight Management Council meeting in Washington were the *Apollo 15* anomalies. These included parachute collapse during landing, lunar module descent battery, lunar surface drill, and steering mechanism on the LRV. Also discussed were the Apollo 16 preparations and the feasibility of TV coverage of the lunar rover during traverse.

The most likely cause of the parachute collapse was damage from burning raw RCS fuel (monomethyl hydrazine) being expelled during depletion firing. Corrective action included landing with reaction control system propellants on board for a normal landing and biasing the propellant load to a slight excess of oxidizer and increasing the time delay inhibiting the rapid propellant dump, to avoid fuel contacting the parachute riser and suspension lines during low-altitude-abort land landings.

Highlights of Manned Space Management Council Meeting," Oct. 18, 1971.

21 Some members of the Lunar Sample Review Board expressed concern that, unless provisions were made to retain vital parts of the Apollo science program for a number of years after the lunar landings were completed, tangible returns from the lunar landings would be greatly diminished. Three main areas of concern were the lunar sample analysis program, the curatorial staff and facilities for care of the sample collection, and the lunar geophysical stations and Apollo orbital science.

Ltr., William W. Rubey and Robert A. Phinney, Cochairmen, Lunar Sample Review Board, to John E. Naugle, NASA Hq., Oct. 21, 1971.

November
18 A detailed objective assessment of the lunar roving vehicle (LRV) used on the *Apollo 15* mission indicated:

- The LRV was successfully deployed, with minor problems. Deployment took 26.5 minutes instead of the allotted time of 17 minutes.
- LRV systems were successfully prepared for traverse. Forward steering was inoperative during EVA-1, but functioned normally on EVA-2 and EVA-3.

- Average speed during traverse was 9.3 kilometers per hour; maximum speed 13 kilometers per hour. Maximum slopes negotiated were up to 12°. Braking distance was 4.6 meters from 10 kilometers per hour.
- The navigation system was extremely accurate.
- Forward visibility was generally excellent.

Ltr., Richard G. Smith, MSFC, to ASPO Manager, "Apollo 15 Objective Assessment Report," Nov. 18, 1971, with encl., "LRV Detailed Objective Assessment."

1971

November

A meeting was held at NASA Hq. to formulate a plan to provide the National Space Science Data Center (NSSDC) with the material required to serve the scientific community. As a result of the meeting, MSC was requested to:

December

7

- Prepare index map overlays and frame indexes for all lunar photos from command module and scientific instrument module cameras.
- Evaluate the photos in terms of the correctness of the exposure settings and the visible effects of any camera malfunctions.
- Manage the preparation of the photo support data and camera calibration data to ensure their suitability for the photogrammetric reduction and subsequent analysis of the photographs.
- Manage the preparation of microfiche imagery of all command module photographs and every third mapping camera photograph, supplying masters and/or copies of the fiches to NSSDC.
- Provide paper prints to NSSDC for the preparation of microfilm imagery of the panoramic camera photographs.

Ltr., Rocco A. Petrone, NASA Hq., to James A. McDivitt, MSC, "Revised Apollo Photo Data Package," Jan. 7, 1972.

Manned Spacecraft Center Robert R. Gilruth was appointed to the newly created position of NASA Director of Key Personnel Development. He would integrate NASA planning to fill key positions, identify actual and potential candidates, and guide them through appropriate work experience.

1972

January

14

Christopher C. Kraft, Jr., MSC Deputy Director, was named Director of MSC. Both Kraft and Gilruth were original members of the NASA Space Task Group established in 1958 to manage Project Mercury.

NASA News Release 72-11, Jan. 14, 1972; MSC News Release 72-15, Jan. 14, 1972.

Sigurd A. Sjoberg was named Deputy Director of Manned Spacecraft Center. Sjoberg succeeded Christopher C. Kraft, Jr., who was named Director of MSC January 14.

18

MSC News Release 72-16, "Sjoberg Named Deputy Director of MSC," Jan. 18, 1972.

- 1972**
January
19
- A directive establishing policy and procedure and assigning responsibilities governing articles to be included in astronaut preference kits flown on board Apollo spacecraft was promulgated.
- Memo, Dale D. Myers, NASA Hq., to Apollo Program Director, "Astronaut Preference Kits—Apollo Missions," Jan. 19, 1972.
- March**
8
- An Olympic Games flag 1.2 by 1.8 meters would be packed in a fireproof container and carried in the command module during the Apollo 16 mission. Weight and storage limitations would preclude carrying the flag in the lunar module. However, an additional Olympic Games flag, 1.2 by 1.8 centimeters, would be carried in the LM flag kit to the lunar surface. Small flags of members of the United Nations, other international organizations, and national states generally accepted as independent in the world community would be carried on the mission in the LM flag kit.
- Memo, Rocco A. Petrone, NASA Hq., to Associate Deputy Administrator, "Flags to Be Carried on Apollo 16," March 8, 1972.
- April**
16–27
- The *Apollo 16* (AS-511) space vehicle was launched from Pad A, Launch Complex 39, KSC, at 12:54 p.m. EST April 16, with a crew of astronauts John W. Young, Thomas K. Mattingly II, and Charles M. Duke, Jr. After insertion into an earth parking orbit for spacecraft system checks, the spacecraft and the S-IVB stage were placed on a trajectory to the moon at 3:28 p.m. CSM transposition and docking with the LM were achieved, although a number of minor anomalies were noted.
- One anomaly, an auxiliary propulsion system leak on the S-IVB stage, produced an unpredictable thrust and prevented a final S-IVB targeting maneuver after separation from the CSM. Tracking of the S-IVB ended at 4:04 p.m. EST April 17, when the instrument unit's signal was lost. The stage hit the lunar surface at 4:02 p.m. April 19, 260 kilometers northeast of the target point. The impact was detected by the seismometers left on the moon by the *Apollo 12*, *14*, and *15* missions.
- Spacecraft operations were near normal during the coast to the moon. Unexplained light-colored particles from the LM were investigated and identified as shredded thermal paint. Other activities during the translunar coast included a cislunar navigation exercise, ultraviolet photography of the earth and moon, an electrophoresis demonstration, and an investigation of the visual light-flash phenomenon noted on previous flights. Astronaut Duke counted 70 white, instantaneous light flashes that left no after-glow.
- Apollo 16* entered a lunar orbit of 314 by 107.7 kilometers at 3:22 p.m. April 19. After separation of LM-11 *Orion* from CSM 112 *Casper*, a CSM active rendezvous kept the two vehicles close together while an anomaly discovered on the service propulsion system was evaluated. Tests and analyses showed the redundant system to be still safe and usable if required. The vehicles were again separated and the mission continued on a revised timeline because of the 5¼-hour delay.



Apollo 16 astronaut Charles M. Duke, Jr., above left, collects lunar samples with surface rake and tongs. John W. Young, standing on the edge of Plum Crater, uses a geological hammer for more samples, having left the Rover on the other side of the 40-meter crater. An oblique view of the moon's far side was photographed from lunar orbit by a camera in the scientific instrument module bay of the CSM. The most conspicuous feature is the smooth-floored Kohlschutter Crater at upper center of the photo; about two-thirds of Mills Crater is at bottom right. Back on earth in MSC's Mission Control Center, *Apollo* Program Director Rocco A. Petrone (standing) and Dr. Gary Latham (kneeling), from Lamont-Doherty Geological Observatory, examine a seismic reading of the Saturn's third-stage impact on the lunar surface.

1972**April**

The lunar module landed with Duke and Young in the moon's Descartes region, about 230 meters northwest of the planned target area at 9:23 p.m. EST April 20. A sleep period was scheduled before EVA.

The first extravehicular activity began at 11:59 a.m. April 21, after the eight-hour rest period. Television coverage of surface activity was delayed until the lunar roving vehicle systems were activated, because the steerable antenna on the lunar module could not be used. The lunar surface experiments packages were deployed, but accidental breaking of the electronics cable rendered the heat flow experiment inoperable. After completing activities at the experiments site, the crew drove the lunar roving vehicle west to Flag Crater, where they performed the planned tasks. The inbound traverse route was just slightly south of the outbound route, and the next stop was Spook Crater. The crew then returned via the experiment station to the lunar module and deployed the solar wind composition experiment. The duration of the extravehicular activity was 7 hours 11 minutes. The distance traveled by the lunar roving vehicle was 4.2 kilometers. The crew collected 20 kilograms of samples.

The second extravehicular traverse, which began at 11:33 a.m. April 22, was south-southeast to a mare-sampling area near the Cinco Craters on Stone Mountain. The crew then drove in a northwesterly direction, making stops near Stubby and Wreck Craters. The last leg of the traverse was north to the experiments station and the lunar module. The second extravehicular activity lasted 7 hours 23 minutes. The distance traveled by the lunar roving vehicle was 11.1 kilometers.

Four stations were deleted from the third extravehicular traverse, which began 30 minutes early at 10:27 a.m. April 23 to allow extra time. The first stop was North Ray Crater, where "House Rock" on the rim of the crater was sampled. The crew then drove southeast to "Shadow Rock." The return route to the LM retraced the outbound route. The third extravehicular activity lasted 5 hours 40 minutes, and the lunar roving vehicle traveled 11.4 kilometers.

Lunar surface activities outside the LM totaled 20 hours 15 minutes for the mission. The total distance traveled in the lunar roving vehicle was 26.7 kilometers. The crew remained on the lunar surface 71 hours 14 minutes and collected 96.6 kilograms of lunar samples.

While the lunar module crew was on the surface, Mattingly, orbiting the moon in the CSM, was obtaining photographs, measuring physical properties of the moon and deep space, and making visual observations. Essentially the same complement of instruments was used to gather data as was used on the *Apollo 15* mission, but different areas of the lunar surface were flown over and more comprehensive deep space measurements were made, providing scientific data that could be used to validate findings from *Apollo 15* as well as add to the total store of knowledge of the moon and its atmosphere, the solar system, and galactic space.

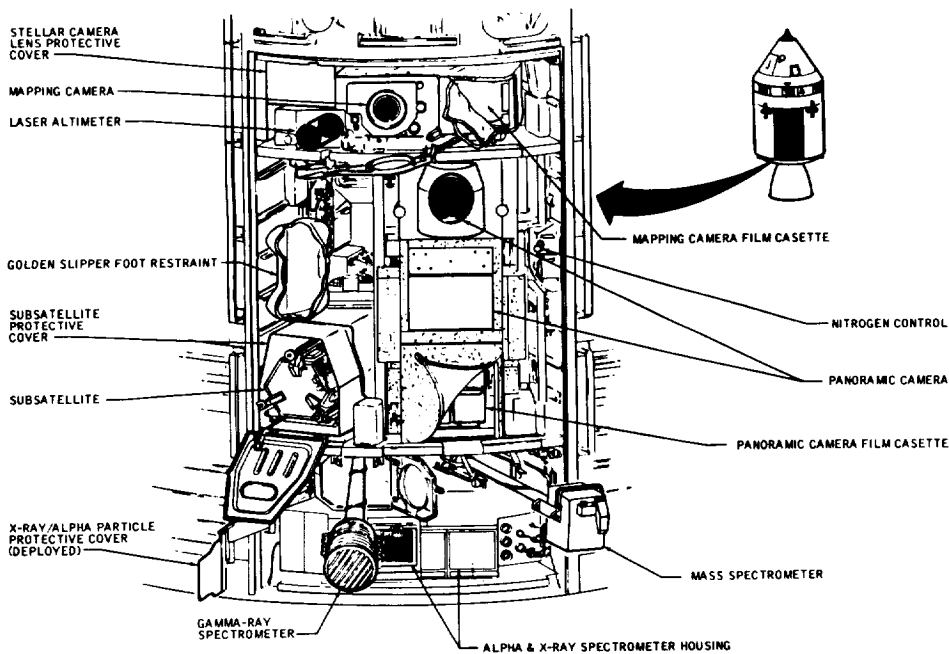

The SIM bay of the *Apollo 16* scientific instrument module housed sensors and experiments to gather data on the moon's atmosphere and surface, as well as a subsatellite to be launched in lunar orbit. Gamma ray and mass spectrometer sensors extended on a boom when in use.

The LM lifted off from the moon at 8:26 p.m. EST April 23, rendezvoused with the CSM, and docked with it in orbit. Young and Duke transferred to the CSM with samples, film, and equipment, and the LM was jettisoned the next day. LM attitude control was lost at jettison; therefore a deorbit maneuver was not possible and the LM remained in lunar orbit, with an estimated orbital lifetime of about one year.

The particles and fields subsatellite was launched into lunar orbit and normal system operation was noted. However, the spacecraft orbital shaping maneuver was not performed before ejection and the subsatellite was placed in a non-optimum orbit that resulted in a much shorter lifetime than the planned year. Loss of all subsatellite tracking and telemetry data on the 425th revolution (May 29) indicated that the subsatellite had hit the lunar surface.

The mass spectrometer deployment boom stalled during a retract cycle and was jettisoned before transearth injection. The second plane-change maneuver and some orbital science photography were deleted so that transearth injection could be performed about 24 hours earlier than originally planned.

1972

April

- 1972**
April
28
- Activities during the transearth coast phase of the mission included photography for a contamination study for the Skylab program and completion of the visual light-flash-phenomenon investigation that had been partially accomplished during translunar coast. A 1-hour 24-minute transearth extravehicular activity was conducted by command module pilot Mattingly to retrieve the film cassettes from the scientific instrument module cameras, inspect the equipment, and expose a microbial-response experiment to the space environment. Two midcourse corrections were made on the return flight to achieve the desired entry interface conditions.
- Entry and landing were normal, completing a 265-hour 51-minute mission. The command module was viewed on television while dropping on the drogue parachutes, and continuous coverage was provided through crew recovery. Splashdown was at 2:44 p.m. EST April 27 in mid-Pacific, 5 kilometers from the recovery ship U.S.S. *Ticonderoga*. All primary mission objectives had been achieved (see Appendix 5).
- MSC, "Apollo 16 Mission Report" (MSC-07230), August 1972; MSC "Apollo 15 (AS-511) Flight Summary," undated; C. M. Lee, NASA Hq., "Mission Director's Summary Report, Apollo 16," April 28, 1972; R. C. Hock, KSC, "Apollo 16 (AS-511) Post-Launch Report," May 2, 1972.
- Owen G. Morris was appointed Manager, Apollo Spacecraft Program Office, at MSC. Morris, who had been Manager for the Lunar Module, succeeded James A. McDivitt, who was appointed Special Assistant to the Center Director for Organizational Affairs. Both appointments were effective immediately.
- MSC Announcement 72-70, "Key Personnel Assignment," April 28, 1972; MSC Announcement 72-71, "Key Personnel Assignment," April 28, 1972.
- May**
7
- A tank cart at the San Diego Naval Air Station, defueling the *Apollo 16* command module after its April 27 return from its mission to the moon, exploded because of overpressurization. Forty-six persons suspected of inhaling of toxic fumes, were hospitalized, but examination revealed no symptoms of inhalation. An Apollo 16 Deactivation Investigation Board completed its report on the accident June 30. The ratio of neutralizer to oxidizer being detanked had been too low because of the extra oxidizer retained in the CM tanks as a result of the *Apollo 15* parachute anomaly. Changes were made in ground support equipment and detanking procedure to prevent future overpressurization.
- Ltr., Scott H. Simpkinson, MSC, to Thomas J. Walker III, Commander, Naval Air Force, U.S. Pacific Fleet, June 30, 1972; "Apollo 16 Mission Anomaly Report No. 1, Oxidizer Deservicing Tank Failure" (MSC-07032), June 1972.
- June**
28
- NASA Deputy Administrator George M. Low and Associate Administrator for Manned Space Flight Dale D. Myers met and decided there was no foreseeable mission for CSMs 115 and 115a; funds would not be authorized

for any work on these spacecraft; and skills would not be retained specifically to work on them.

1972

June

Memos, Harry H. Gorman, NASA Hq., to Directors, Apollo Program and Skylab Program, July 6, 1972; Myers to Christopher C. Kraft, Jr., MSC, "Storage and Utilization of Apollo Command and Service Modules," Oct. 30, 1972; ltr., Kraft to Myers, NASA Hq., Sept. 27, 1972.

A meeting at NASA Hq. reviewed the proposed photographic and visual observation tasks of the command module pilot during the Apollo 17 mission scheduled for December. Feasibility of the tasks and potential flight planning impact were discussed.

July

13

Memo, George F. Esenwein, NASA Hq., to distr., "Apollo 17 CM Photographic and Visual Observation Tasks," July 26, 1972.

The Lunar Science Institute's summer study on post-Apollo lunar science arrived at a number of conclusions and recommendations. Some conclusions were: Lunar science would evolve through three rather distinct phases. For two years immediately following Apollo 17, high priority would be given to collection, organization, and preliminary analysis of the wealth of information acquired from the exploration of the moon. In the next two years (1975 and 1976), emphasis would shift to a careful first look at all the data. In the next years, investigations would be concentrated on key problems.

15

Some recommendations were: The tasks being carried out by NASA to preserve and describe the samples, data, and photographs, and to make them available to the scientific community would need to continue for the next few years. The lunar sample curatorial facility at MSC was absolutely essential to lunar science objectives. The ALSEP network and the subsatellite should be operated continuously as long as significant new findings derived from their operation.

Ltr., Joseph W. Chamberlin, Lunar Science Institute, to John Naugle, NASA Hq., July 15, 1972.

During the Apollo 17 mission, MSC would be responsible for the medical briefing at the mission reviews, would provide the medical staffing of the mission operations control room, would assume the medical line responsibilities in the operations team, and would provide mission surgeons to take part in the change-of-shift press briefings.

September

26

Ltr., Christopher C. Kraft, Jr., MSC, to Dale D. Myers, NASA Hq., Sept. 26, 1972.

Apollo 17 (AS-512), the final Apollo manned lunar landing mission, was launched from Pad A, Launch Complex 39, KSC, at 12:33 a.m. EST December 7. Crew members were astronauts Eugene A. Cernan, Ronald E. Evans, and Harrison H. Schmitt. The launch had been delayed 2 hours 40 minutes by a countdown sequencer failure, the only such delay in the Apollo program caused by a hardware failure.

December

7-19

1972

December

All launch vehicle systems performed normally in achieving an earth parking orbit of 170 by 168 kilometers. After checkout, insertion into a lunar trajectory was begun at 3:46 a.m.; translunar coast time was shortened to compensate for the launch delay. CSM 114 transposition, docking with LM-12, and LM ejection from the launch vehicle stage were normal. The S-IVB stage was maneuvered for lunar impact, striking the surface about 13.5 kilometers from the preplanned point at 3:27 p.m. EST December 10. The impact was recorded by the passive seismometers left on the moon by *Apollo 12*, *14*, *15*, and *16*.

The crew performed a heat flow and convection demonstration and an Apollo light-flash experiment during the translunar coast. The scientific instrument module door on the SM was jettisoned at 10:17 a.m. EST December 10. The lunar orbit insertion maneuver was begun at 2:47 p.m. and the *Apollo 17* spacecraft entered a lunar orbit of 315 by 97 kilometers. After separation of the LM *Challenger* from the CSM *America* and a readjustment of orbits, the LM began its powered descent and landed on the lunar surface in the Taurus-Littrow region at 2:55 p.m. EST on December 11, with Cernan and Schmitt.

The first EVA began about 4 hours later (6:55 p.m.). Offloading of the lunar roving vehicle and equipment proceeded as scheduled. The Apollo Lunar Surface Experiment Package was deployed approximately 185 meters west northwest of the *Challenger*. Astronaut Cernan drove the lunar roving vehicle to the experiments deployment site, drilled the heat flow and deep core holes, and emplaced the neutron probe experiment. Two geological units were sampled, two explosive packages deployed, and seven traverse gravimeter measurements were taken. During the 7-hour 12-minute EVA, 14 kilograms of samples were collected.

The second extravehicular activity began at 6:28 p.m. EST December 12. Because of geological interest, station stop times were modified. Orange soil was discovered and became the subject of considerable geological discussion. Five surface samples and a double core sample were taken in the area of the orange soil. Three explosive packages were deployed, seven traverse gravimeter measurements were taken, and observations were photographed. Samples collected totaled 34 kilograms during the 7 hours and 37 minutes of the second EVA.

The third and final EVA began at 5:26 p.m. EST December 13. Specific sampling objectives were accomplished. Samples—including blue-gray breccias, fine-grained vesicular basalts, crushed anorthositic rocks, and soils—weighed 66 kilograms. Nine traverse gravimeter measurements were made. The surface electrical properties experiment was terminated. Before reentering the LM, the crew selected a breccia rock to dedicate to the nations represented by students visiting the Mission Control Center. A plaque on the landing gear of the lunar module, commemorating all of the Apollo lunar landings, was then unveiled. After 7 hours 15 minutes, the last Apollo EVA on the lunar surface ended. Total time of the three EVAs was

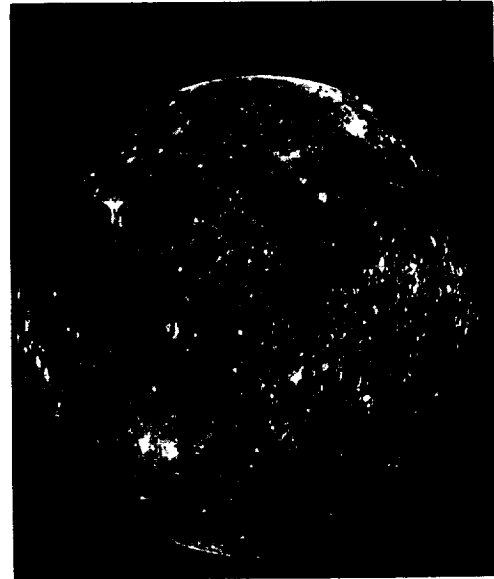
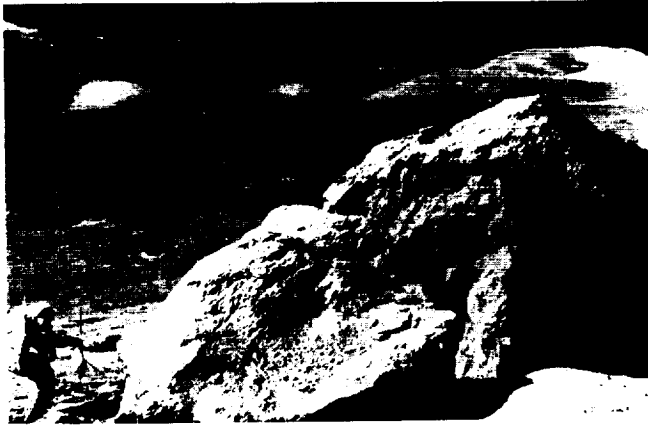
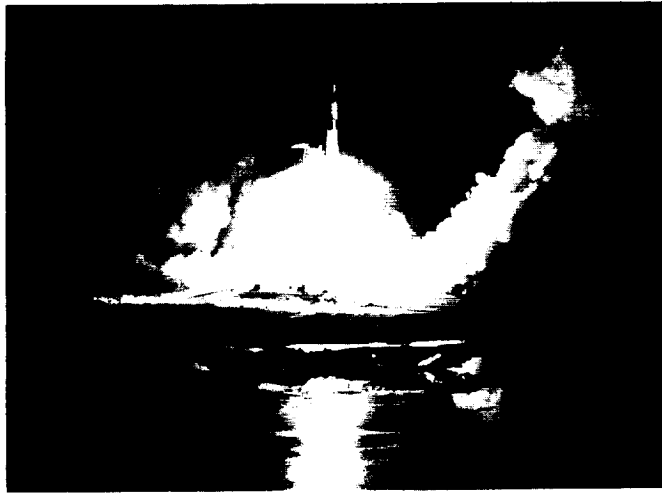

Last Apollo mission to the moon: Saturn V thrusts *Apollo 17* into flight in the first nighttime Apollo launch. In explorations on the lunar surface six days later, astronaut Harrison H. Schmitt was photographed by Eugene A. Cernan as he studied the huge split boulder found at the base of North Massif during their third EVA. After their liftoff to rejoin the CSM and Ronald E. Evans in orbit, and just after they entered the return path for home, the receding full moon was photographed with one-third of its far side visible. Behind them at Taurus-Littrow, the astronauts left a plaque attached to the LM *Challenger's* descent stage.

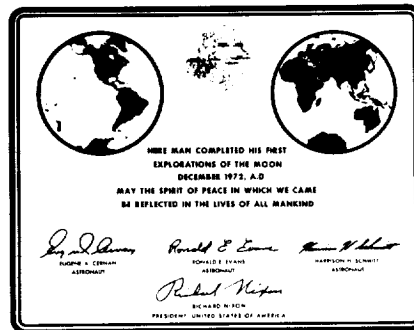

1972
December

approximately 22 hours; the lunar roving vehicle was driven 35 kilometers, and about 115 kilograms of lunar sample material was acquired.

While Cernan and Schmitt were exploring the lunar surface, Evans was conducting numerous scientific activities in the CSM in lunar orbit. In addition to the panoramic camera, the mapping camera, and the laser altimeter, three new scientific instrument module experiments were included in the *Apollo 17* orbital science equipment. An ultraviolet spectrometer measured lunar atmospheric density and composition; an infrared radiometer mapped the thermal characteristics of the moon; and a lunar sounder acquired data on the subsurface structure.

Challenger lifted off the moon at 5:55 p.m. EST December 14. Rendezvous with the orbiting CSM and docking were normal. The two astronauts transferred to the CM with samples and equipment and the LM ascent stage was jettisoned at 1:31 a.m. December 15. Its impact on the lunar surface about 1.6 kilometers from the planned target was recorded by four *Apollo 17* geophones and the *Apollo 12, 14, 15, and 16* seismometers emplaced on the surface. The seismic experiment explosive packages that had been deployed on the moon were detonated as planned and recorded on the geophones.

During the coast back to earth, Evans left the CSM at 3:27 p.m. EST December 17 for a 1-hour 7-minute inflight EVA and retrieved lunar sounder film and panoramic and mapping camera cassettes from the scientific instrument module bay. The crew conducted the Apollo light-flash experiment and operated the infrared radiometer and ultraviolet spectrometer.

Reentry, landing, and recovery were normal. The command module parachuted into the mid-Pacific at 2:25 p.m. EST December 19, 6.4 kilometers from the prime recovery ship, U.S.S. *Ticonderoga*. The crew was picked up by helicopter and was on board the U.S.S. *Ticonderoga* 52 minutes after the CM landed. All primary mission objectives had been achieved (see Appendix 5).

MSC "Apollo 17 Mission Report," March 1973; MSC "Apollo 17 (AS-512) Flight Summary," undated; KSC. "Apollo 17 Post-Launch Report" (RCS-76-0000-0048), Dec. 19, 1972.

8

"Apollo, of course, was an absolutely unprecedented event in human history, one whose ultimate importance is impossible to fully comprehend at such close range," NASA Associate Administrator for Manned Space Flight Dale D. Myers wrote the Administrator. "In addition, its scientific contributions have far exceeded the expectations not only of the skeptics, but even of its proponents. It has virtually created a new branch of science as well as added a brilliant new chapter in the annals of exploration."

Myers, NASA Hq., to the NASA Administrator, "Scope of the Skylab Experiment Program," Dec. 8, 1972.

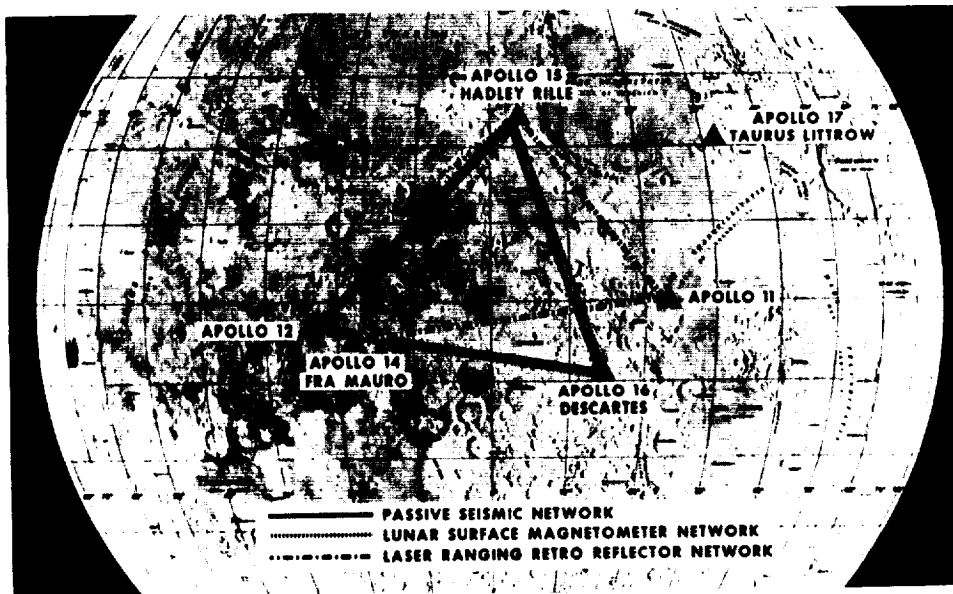

Science stations set up on the lunar surface by Apollo astronaut crews.

Former President Lyndon B. Johnson—who as Senator had drafted the National Aeronautical and Space Act of 1958 establishing NASA and as Vice President had chaired the National Aeronautics and Space Council at the time of the U.S. decision to land a man on the moon—died of a heart attack in Austin, Tex., at the age of 64.

A letter Johnson had sent was read at the National Space Club's "Salute to Apollo" in Washington, D.C., in the evening. Johnson commended the "space pioneers who have made the Apollo miracle a living reality." He said: "It has been more, so much more than an amazing adventure into the unexplored and the unknown. The Apollo Program . . . will endure as a monument to many things, to the personal courage of some of the finest men our nation has ever produced, to the technological and managerial capability which is the genius of our system and to a successful cooperation among nations which has proved to us all what can be done when we work together with our eyes on a glorious goal.

"I rate Apollo as one of the real wonders of the world and I am proud that my country, through the exercise of great ability and daring leadership, has given it as a legacy to mankind."

Washington Post, Jan. 23, 1973, p. A1; *Congressional Record-Senate*, Jan. 29, 1973, p. S1467; transcript of proceedings, "Salute to Apollo," Jan. 22, 1973.

Ames Research Center requested that six R4D rocket engines designed for use in the Apollo program be transferred from MSC to Ames. Possibly the

1973

January

22

26

- 1973**
January
 engines would be suitable for the retro-injection function in the Pioneer Venus series of atmospheric probe and orbiter missions. First launch was planned for early 1977.
 Ltr., R. R. Nunamaker, Ames Research Center, to M. A. Faget, MSC, "Apollo surplus R4D rocket engines for Pioneer Venus," Jan. 26, 1973.
- February**
 17
 The Manned Spacecraft Center was renamed the Lyndon B. Johnson Space Center by Public Law 93-8. The late President's interest and support of the space program began while he was Chairman of the Senate Committee on Aeronautical and Space Sciences and continued during his tenure as Vice President and President (see January 22).
 MSC Announcement 73-34, "Renaming of the Manned Spacecraft Center," Feb. 27, 1973.
- March**
 6
 The Apollo Spacecraft Program Office, with Glynn S. Lunney as Manager, was reorganized. Lunney was also Manager for ASTP (Apollo/Soyuz Test Project), an assignment to which he had been appointed in June of 1972.
 JSC Announcement 73-37, "Reorganization of the Apollo Spacecraft Program Office," March 6, 1973; MSC Announcement 72-98, "Key Personnel Assignments," June 26, 1972; ltr., Christopher C. Kraft, Jr., JSC, to Dale D. Myers, NASA Hq., March 2, 1973.
- 15
 A Lunar Programs Office, under which the Lunar Data Analysis and Synthesis Program would be conducted, was established in the Office of Space Science, NASA Hq. The office was responsible for continued operation and collection of data from the Apollo lunar surface experiment packages and the *Apollo 15* subsatellite; Apollo surface and orbital science data analysis by principal investigators; development of selenodetic, cartographic, and photographic products; continued lunar laser ranging experiment; continued lunar sample analysis; lunar supporting research and technology; and advanced program studies.
 Ltr., John E. Naugle, NASA Hq., to Colleagues, March 15, 1973.
- August**
 7
 National Air and Space Museum Director Michael Collins advised JSC that NASM had established a center for research and study with responsibility for a complete library of lunar photos to document scientific results of the Apollo missions. The library would be used for original research and for planning and updating scientific parts of exhibits.
 Ltr., Collins to Christopher C. Kraft, Jr., Director, JSC, Aug. 7, 1973.
- 27
 Apollo Soyuz Test Project Program Director Chester M. Lee, Office of Manned Space Flight, NASA Hq., was assigned as the management official to take actions necessary for the final phaseout of the Apollo program. All Apollo program inquiries, activities, and actions not covered by specific delegations of authority would be referred to Lee for appropriate decision and disposition.
 NASA Notice 8020, "Apollo Program Phaseout Activities," Aug. 27, 1973.

A stained glass window designed to contain a 7.18-gram rock from the Moon's Sea of Tranquility was dedicated at the Washington Cathedral in a July 21, 1974, service marking the fifth anniversary of the *Apollo 11* lunar landing. Former NASA Administrator Thomas O. Paine donated the window, designed by St. Louis artist Rodney Winfield with whirling stars and orbiting planets in orange, red, and white on a deep blue and green field—an abstract interpretation of man's spiritual reflections in space. The rock would be set in place later.



With the support of the trustees of the Washington Cathedral, Francis B. Sayre and Thomas O. Paine commissioned a large stained glass Space Window to be installed in the south wall of the nave, the main auditorium of the Cathedral. The window would be 5.4 meters high by 2.7 meters wide. The center of the window would contain an *Apollo 11* lunar sample 2 centimeters in diameter.

Ltrs., Paine, former NASA Administrator, to President Nixon, Nov. 2, 1973; Paine to J. C. Fletcher, NASA Hq., Nov. 2, 1973; Nixon to Paine, Jan. 14, 1974; G. P. Chandler, NASA Hq., to E. A. Cernan, MSC, Jan. 23, 1974; Fletcher to C. C. Kraft, Jr., MSC, Feb. 5, 1974.

Universal Studios filmed a program for the ABC TV Network entitled, "Houston, We've Got a Problem." Although fictitious, the show revolved around mission control and the flight controllers during the *Apollo 13* mission. The production was televised March 2, 1974.

Memo, John P. Donnelly, NASA Hq., to Deputy Administrator, Feb. 21, 1974.

Of the 134 *Apollo 17* lunar plaques, 93 were presented by American embassies to the countries in which the embassies were located.

Memo, John P. Donnelly, NASA Hq., to the Administrator and Deputy Administrator, "Status Report on Presentation of Apollo 17 Lunar Plaques," March 4, 1974.

1973

November

2

1974

January

**During
the
Month**

4

1974

July

13

In recognition of the fifth anniversary of the *Apollo 11* flight, which landed the first men on the moon, President Nixon proclaimed the period July 16 through July 24 as United States Space Week, stating: "The knowledge to be gained from space will lead to scientific, technological, medical and industrial advances which cannot be fully perceived today. In time man may take for granted in the heavens such wonders as we cannot imagine—just as superhighways across America would amaze the Puritans of 1620 or transatlantic flights would astound those who passed on the legend of Icarus. But we know that a beginning has been made that will affect the course of human life forever."

Presidential Proclamation 4303, "United States Space Week, 1974," July 13, 1974.

APPENDIXES



APPENDIX 1—GLOSSARY OF ABBREVIATIONS AND ACRONYMS

AAP	Apollo Applications Program
ACBWG	Apollo Reentry Communications Blackout Working Group
ACE	acceptance checkout equipment; also automatic checkout equipment
ACE S/C	acceptance checkout equipment spacecraft
ACED	AC Electronics Division, General Motors Corporation
AEC	Atomic Energy Commission
AEDC	Arnold Engineering Development Center, Air Force
AES	Apollo Extension System, forerunner of Apollo Applications Program
AFETR	Air Force Eastern Test Range
AFRM	airframe
AFSC	Air Force Systems Command
ALEP	Apollo lunar exploration program
ALSEP	Apollo Lunar Surface Experiments Package
ALSD	Apollo lunar surface drill
AMS	Apollo mission simulator
AOH	Apollo operations handbook
AP	Associated Press
ARC	Ames Research Center
AS	Apollo-Saturn
ASPO	Apollo Spacecraft Program Office, MSC
ASSB	Apollo Site Selection Board
ASTT	Apollo Special Task Team
ATM	Apollo telescope mount
BAC	Bell Aerospace Company or, before January 1970, Bell Aerosystems Company
BeV	billion electron volts
BIG	biological isolation garment
BTU	British thermal unit
°C	degrees Celsius (centigrade)
CARIDS	customer acceptance review item dispositions
CARR	Customer Acceptance Readiness Review
CASE	Coordinated Aerospace Supplier Evaluation
cc	cubic centimeter(s)
CCB	Configuration Control Board
CDR	commander
cm	centimeter(s)
CM	command module
CMP	command module pilot
cps	cycles per second (see Hz)
CSM	command and service modules
cu m	cubic meter(s)
DCR	Design Certification Review
DFI	development flight instrumentation

DOD	Department of Defense
DPS	descent propulsion system
EASEP	Early Apollo Science Experiments Package
ECP	engineering change proposal
ECS	environmental control system
EDCP	engineering design change proposal
EDS	emergency detection system
ELS	earth landing system
EMS	entry monitor system
EMU	extravehicular mobility unit
EO	engineering order
eV	electron volts(s)
EVA	extravehicular activity
°F	degrees Fahrenheit
FCOD	Flight Crew Operations Directorate
FCSM	flight combustion stability monitor
FAI	Fédération Aéronautique Internationale (International Aeronautical Federation)
FOD	Flight Operations Directorate
FRR	Flight Readiness Review
G	specific gravity
g	gram, gravity
GAEC	Grumman Aircraft Engineering Corporation
GAO	Government Accounting Office
GE	General Electric Company
GET	ground elapsed time
GFE	government-furnished equipment
GLEP	Group for Lunar Exploration Planning
GMT	Greenwich mean time
GSE	ground support equipment
GSFC	Goddard Space Flight Center
HEAO	High Energy Astronomy Observatory (satellite)
HF	high frequency
Hz	hertz (unit of frequency: 1 cycle per second)
IBM	International Business Machines Corporation
ICBC	Interagency Committee on Back Contamination
IMU	inertial measurement unit
ITT	International Telephone and Telegraph Corporation
j	joule
JPL	Jet Propulsion Laboratory
JSC	Johnson Space Center (Manned Spacecraft Center before February 1973)
K	kelvin(s)
kg	kilogram(s)
km	kilometer(s)
km/hrs	kilometers per hour
KSC	Kennedy Space Center
LaRC	Langley Research Center

APPENDIX I

LC	Launch Complex
LEM	lunar excursion module
LeRC	Lewis Research Center
LES	launch escape system
LGI	lunar geology investigation
LION	Lunar International Observer Network
LLRF	Lunar Landing Research Facility
LLRV	lunar landing research vehicle
LLTV	lunar landing training vehicle
LM	lunar module
LMP	lunar module pilot
LMS	lunar module simulator
LMSS	lunar mapping and survey system
LOI	lunar orbit insertion
LOLA	lunar orbit and landing approach
LOX	liquid oxygen
LRL	Lunar Receiving Laboratory
LRV	lunar roving vehicle
LSI	Lunar Science Institute
LTA	lunar module test article
m	meter(s)
mascons	mass concentrations of dense material on lunar surface
Mc	megacycles
MCC (H) (K)	Mission Control Center (Houston) (Kennedy)
MCP	mission control programmer
MCR	master change record
MDF	mild detonating fuse
MDOP	maximum design operating pressure
MET	mobile equipment transporter
MeV	million electron volts
MHz	megahertz (million cycles per second)
min	minute(s)
MIT	Massachusetts Institute of Technology
NASM	National Air and Space Museum, Smithsonian Institution
mm	millimeter
MMH	monomethylhydrazine
MOL	Manned Orbiting Laboratory
MRB	Material Review Board
MSC	Manned Spacecraft Center (became Johnson Space Center February 1973)
MSFC	Marshall Space Flight Center
MSFN	Manned Space Flight Network
MSOB	Manned Spacecraft Operations Building
M&SS	Mapping and survey system
Mw	megawatt(s)
NAA	North American Aviation, Inc. (until Sept. 22, 1967)
NAR (NR)	North American Rockwell Corporation (Sept. 22, 1967–Feb. 16, 1973; then Rockwell International Corporation)

NAS	National Academy of Sciences
NASA	National Aeronautics and Space Administration
nm	nautical mile(s)
NR	North American Rockwell Corporation (North American Aviation, Inc., before Sept. 22, 1967; Rockwell International Corporation Feb. 16, 1973)
NSSDC	National Space Science Data Center
OAO	Orbiting Astronomical Observatory (satellite)
OART	Office of Advanced Research and Technology, NASA Headquarters
OAS	optical alignment sights
OCP	Operational Checkout Procedure
OMSF	Office of Manned Space Flight, NASA Headquarters
OPS	oxygen purge system
ORDEAL	orbital rate drive electronics for Apollo and LM
ORI	operational readiness inspection
OSO	Orbiting Solar Observatory (satellite)
OSSA	Office of Space Science and Applications, NASA Headquarters
OTDA	Office of Tracking and Data Acquisition, NASA Headquarters
PAD	project approval document
PDR	Preliminary Design Review
PGA	pressure garment assembly
PHS	Public Health Service
PI	principal investigator
PIB	Pyrotechnic Installation Building
PLSS	portable life support system
pogo	launch vehicle induced oscillations (not an acronym; derived from "pogo stick" analogy)
PSAC	President's Scientific Advisory Committee
psi	pounds per square inch
psia	pounds per square inch absolute
PTV	parachute test vehicle
RASPO	Resident Apollo Spacecraft Program Office
RCA	Radio Corporation of America
RCS	reaction control system
RF	radio frequency
RTCC	Real Time Computer Complex
RTG	radioisotope thermoelectric generator
RTV	room temperature vulcanizing
SAMSO	Space and Missiles Organization, Air Force
S/C	spacecraft
SEB	Source Evaluation Board
sec	second(s)
SEQ	scientific equipment
SESL	Space Environmental Simulation Laboratory
SEVA	Stand-up extravehicular activity
S-IB	Saturn IB launch vehicle first stage
S-IC	Saturn V launch vehicle first stage
S-II	Saturn second stage

APPENDIX I

S-IVB	Saturn IB second stage; Saturn V third stage
SID	Space and Information Systems Division, NAA
SIM	scientific instrument module
SLA	spacecraft-lunar module adapter
SLSS	supplementary life support system
SM	service module
SPF	single point failure
SPS	service propulsion system
sq cm	square centimeter(s)
sq m	square meter(s)
SSC	spacesuit communications
STAC	Scientific and Technical Advisory Committee, university-NASA
STG	Space Task Group, NASA (forerunner of Manned Spacecraft Center); Space Task Group, President's (1969)
SWIP	Super Weight Improvement Program
TCP	test and checkout procedures
TEI	transearth injection (insertion into trajectory to earth)
TLI	translunar injection (insertion into trajectory to moon)
TM	test model
TV	thermal vacuum test article; also television
V	volt(s)
VHF	very high frequency
W	watt(s)
WIF	Water Immersion Facility
WSMR	White Sands Missile Range, Army
WSTF	White Sands Test Facility, MSC, NASA

APPENDIX 2—MAJOR SPACECRAFT COMPONENT MANUFACTURERS

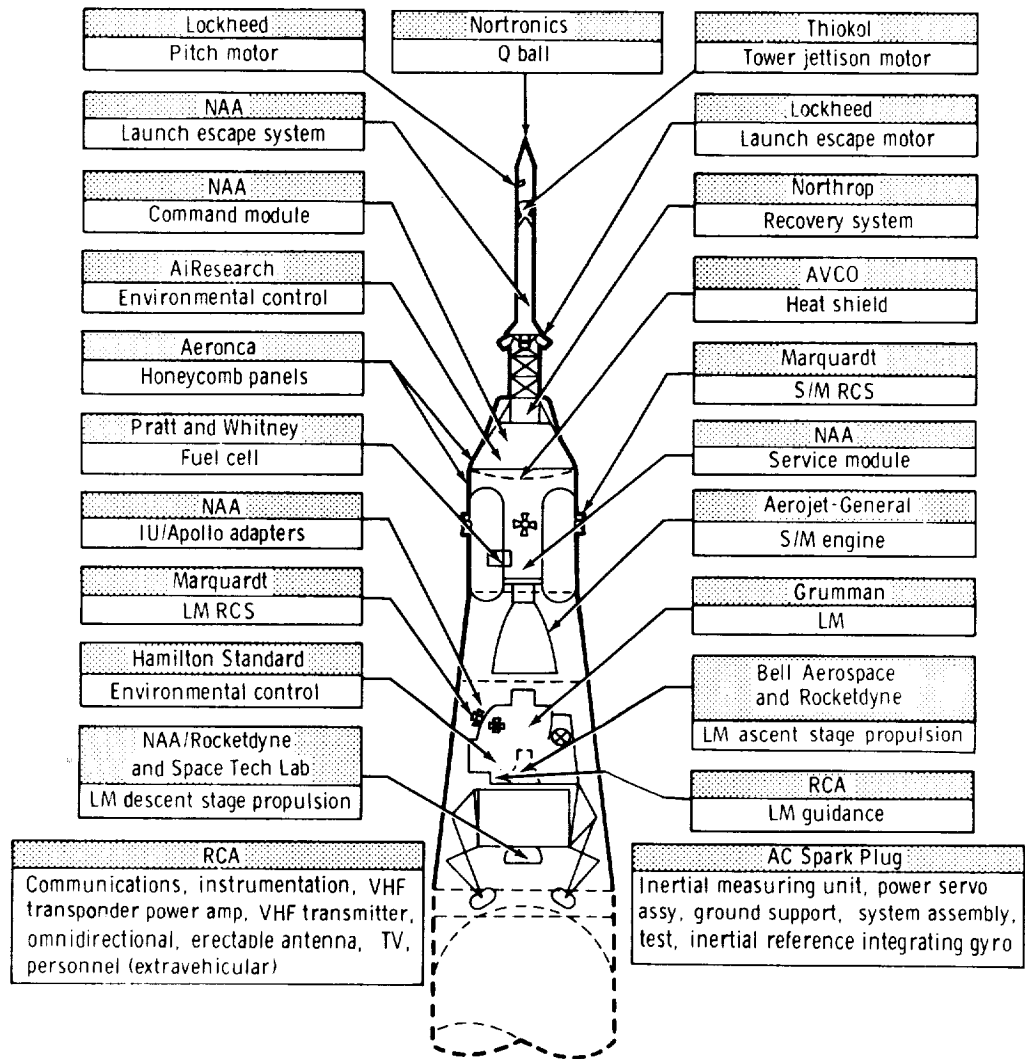

Honeywell Company	Collins Radio	Link	Beech Aircraft	Bell Aerosystems
Stabilization, control	Telecommunications	Spacecraft mission simulators	Supercritical gas storage	RCS positive expulsion fuel tanks
Allison and Airite Products	Radiation Inc.	Simmonds Precision Products	RCA	Westinghouse Electric
Fuel components	Telemetry data processing for Apollo S-II stage	Propellant mixture controls	TV cameras, main communications antenna	Static inverter
Elgin National Watch	RCA	MIT	Raytheon	Kollsman Instrument
Sequencer	Radar, engineering services	Associate prime-guidance, navigation	Computer	Optics

*STL named sole contractor January 1965.

APPENDIX 3—OFFICIAL U.S. INTERNATIONAL AERONAUTICAL FEDERATION WORLD RECORDS

[Prepared by Carl R. Huss, Data Systems and Analysis Directorate, JSC.]

Mission, Date	Crew	Record	Numbers
<i>Mercury flights</i> <i>MR-3</i> May 5, 1961	Alan B. Shepard, Jr.	Altitude without earth orbit	186.6 km (116 mi)
<i>Gemini flights</i> <i>Gemini V</i> Aug. 21-29, 1965	L. Gordon Cooper, Jr. Charles Conrad, Jr.	1. Distance with earth orbit, 2-4 astronauts 2. Duration with earth orbit, 2-4 astronauts	5 326 133.6 km (3 309 506 mi) 190 hrs 56 min
<i>Gemini VII</i> Dec. 4-18, 1965	Frank Borman James A. Lovell, Jr.	1. Distance with earth orbit, 2-4 astronauts 2. Duration with earth orbit, 2-4 astronauts	9 204 573.8 km (5 719 457 mi) 330 hrs 35 min 330 hrs 35 min
<i>Gemini X</i> July 18-21, 1966	John W. Young Michael Collins	Greatest altitude with earth orbit. 2-4 astronauts	766 km (476 mi)
<i>Gemini XI</i> Sept. 12-15, 1966	Charles Conrad, Jr. Richard F. Gordon, Jr.	Greatest altitude with earth orbit, 2-4 astronauts	1368.98 km (850.65 mi)

APPENDIX 3—OFFICIAL U.S. IAF WORLD RECORDS—Continued

Mission, Date	Crew	Record	Numbers
<i>Apollo flights</i>			
<i>Apollo 7</i> Oct. 11-22, 1968	Walter M. Schirra, Jr. R. Walter Cunningham Donn F. Eisele	1. Greatest mass lifted to altitude 2. World class—greatest mass lifted to orbit, 2-4 astronauts	14 771.6 kg (32 566 lbs)
<i>Apollo 8</i> Dec. 21-27, 1968	Frank Borman James A. Lovell, Jr. William A. Anders	1. Greatest mass lifted to altitude 2. Highest altitude 3. World class—greatest mass lifted to orbit, 2-4 astronauts 4. World class—highest altitude, 2-4 astronauts 5. Duration of a lunar mission 6. Duration in lunar orbit, 2-4 astronauts 7. Total time in space, 1 astronaut	128 002.4 kg (282 197 lbs) 377 349.38 km (203 752.37 nm) 128 002.4 kg (282 197 lbs) 377 349.38 km (203 752.37 nm) 147 hrs 42 min 20 hrs 6 min 49 sec (10 orbits) 572 hrs 10 min 16 sec
<i>Apollo 9</i> March 3- 13, 1969	James A. McDivitt David R. Scott Russell L. Schweickart	1. Longest duration outside spacecraft (EVA) 2. Longest duration in group flight, linked 3. Greatest mass in group flight, linked 4. Greatest distance in group flight, linked 5. Longest duration in group flight	47 min 1 sec 21 hrs 36 min 31 sec 28 428.9 kg (62 675 lbs) 602 488.9 km (325 318 nm) 26 hrs 32 min 59 sec
<i>Apollo 10</i> May 18-26, 1969	Thomas P. Stafford John W. Young Eugene A. Cernan	1. Duration of a lunar mission 2. Duration in lunar orbit	192 hrs 3 min 23 sec 31 orbits

<i>Apollo 11</i> July 16-24, 1969	Neil A. Armstrong Michael Collins Edwin E. Aldrin, Jr.	<ol style="list-style-type: none"> 1. Duration of stay on the surface of the moon 2. Greatest mass landed on the moon 3. Duration of stay inside spacecraft on lunar surface 4. Duration of stay outside spacecraft on lunar surface 5. Greatest mass lifted to lunar orbit from lunar surface 6. Duration of stay outside spacecraft (world absolute) 	<p>21 hrs 36 min 21 sec 7326.9 kg (16 153.2 lbs) 19 hrs 49 min 28 sec</p> <p>2 hrs 31 min 40 sec</p> <p>2689.1 kg (5928.6 lbs) 2 hrs 31 min 40 sec</p>
<i>Apollo 12</i> Nov. 14-24, 1969	Charles Conrad, Jr. Richard F. Gordon, Jr. Alan L. Bean	<ol style="list-style-type: none"> 1. Duration of a lunar mission 2. Duration of stay on lunar orbit 3. Duration of stay on lunar surface 4. Duration of stay outside the spacecraft 5. Duration of stay on lunar surface for crewmen 6. Total continuous time outside the spacecraft for one crewman 7. Total accumulated time outside the spacecraft for one crewman 	<p>244 hrs 36 min 25 sec 88 hrs 56 min 1 sec 31 hrs 31 min 12 sec 25 hrs 6 min 49 sec 14 hrs 2 min 25 sec 3 hrs 52 min 6 sec</p> <p>7 hrs 37 min 37 sec</p>
<i>Apollo 13</i> April 11- 17, 1970	James A. Lovell, Jr. Fred W. Haise, Jr. John L. Swigert, Jr.	<ol style="list-style-type: none"> 1. Total duration of stay outside spacecraft (EVA) by one astronaut for a single mission 2. Total duration of stay outside spacecraft on lunar surface for single mission (total accumulation for all crewmen) (world class for lunar mission) 	<p>715 hrs 4 min 57 sec</p> <p>9 hrs 12 min 27 sec 17 hrs 33 min 29 sec</p>
<i>Apollo 14</i> Jan. 31- Feb. 9, 1971	Alan B. Shepard, Jr. Edgar D. Mitchell Stuart A. Roosa		

APPENDIX 3—OFFICIAL U.S. IAF WORLD RECORDS—Concluded

Mission, Date	Crew	Record	Numbers
<i>Apollo 15</i> July 26- Aug. 7, 1971	David R. Scott Alfred M. Worden James B. Irwin	3. Maximum distance traveled on lunar surface away from spacecraft (world class for lunar mission)	1453.8 m (4770 ft)
		1. Total time outside spacecraft on lunar surface for one crewman during one mission	18 hrs 18 min 26 sec
		2. Maximum radial distance traveled away from spacecraft on lunar surface	5020 m (16 470 ft)
		3. Greatest mass to lunar orbit from earth	34 599.1 kg (76 278 lbs)
<i>Apollo 16</i> April 16- 27, 1972	John W. Young Thomas K. Mattingly II Charles M. Duke, Jr.	1. Duration of stay in lunar orbit	125 hrs 46 min 50 sec
		2. Duration of stay on lunar surface	71 hrs 2 min 13 sec
		3. Duration of stay outside spacecraft for all crewmen on a single mission	39 hrs 4 min 3 sec
		4. Greatest mass landed on surface of moon	8259 kg (18 208 lbs)
		5. Greatest mass lifted from lunar surface	4966.3 kg (10 949 lbs)
<i>Apollo 17</i> Dec. 7-19, 1972	Eugene A. Cernan Ronald E. Evans Harrison H. Schmitt	1. Total time outside spacecraft for one crewman on a single mission (world absolute)	21 hrs 31 min 44 sec
		2. Total time outside spacecraft for one crewman on a single lunar mission	21 hrs 31 min 44 sec
		3. Total time in lunar orbit (world class—lunar mission)	147 hrs 41 min 13 sec
		4. Maximum distance traveled radially away from spacecraft on the lunar surface	7628.8 m (25 029 ft)
		5. Duration of a lunar mission	301 hrs 51 min 57 sec

APPENDIX 4—FLIGHT SUMMARY

[January 21, 1966, through December 19, 1972]

ETR = Eastern Test Range S = Successful
 WS = Wallops Station P = Partially Successful
 KSC = Kennedy Space Center U = Unsuccessful

Date	Name	General Mission	Launch Vehicle, Site	Performance		
				Vehicle	Payload	Mission Results
<i>1966</i>						
Jan. 31	<i>Luna 9</i> (U.S.S.R.)	Soft-land on moon; take TV photos of lunar surface and measurements of cosmic radiation and transmit to earth.	Not available			Soft-landed on moon Feb. 3.
Feb. 26	Apollo-Saturn 201 (AS-201)	Unmanned suborbital launch vehicle development test. First flight of Saturn IB and of Apollo spacecraft (CSM 009).	Saturn IB (ETR)	S	S	S
Mar. 16	<i>Gemini VIII</i> <i>GATV</i>	Gemini-Agena Target Vehicle for <i>Gemini VIII</i> rendezvous and docking exercise.	Atlas-GATV (ETR)	S	S	S
Mar. 16	<i>Gemini VIII</i>	Neil A. Armstrong and David R. Scott in orbital space flight to rendezvous with GATV and make first docking in space.	Titan II (ETR)	S	P	S

APPENDIX 4—FLIGHT SUMMARY—Continued

Date	Name	General Mission	Launch Vehicle, Site	Performance		
				Vehicle	Payload	Mission Results
<i>1966—continued</i>						
Mar. 31	<i>Luna 10</i> (U.S.S.R.)	Maneuver spacecraft into vicinity of moon; test systems for putting satellite in orbit around moon.	Not available	S	S	S
May 17	Gemini IX GATV	Gemini-Agena Target Vehicle for planned rendezvous and docking mission; failed to orbit after launch. Launch of manned Gemini IX was canceled.	Atlas-GATV (ETR)	U	Unknown	U
May 30	<i>Surveyor 1</i> (Surveyor A)	First U.S. attempt at soft-landing on moon. Spacecraft landed June 2. TV photos were excellent.	Atlas-Centaur (ETR)	S	S	S
Jun. 1	<i>Gemini IX-A</i> <i>ATDA</i>	Augmented Target Docking Adapter launched into orbit as target vehicle for manned <i>Gemini IX-A</i> rendezvous and docking.	Atlas-ATDA (ETR)	S	P	U
Jun. 3	<i>Gemini IX-A</i>	Thomas P. Stafford and Eugene A. Cernan, launched into orbit, rendezvoused with ATDA during 3d orbit but	Titan II (ETR)	S	P	U

	docking was not possible because ATDA's shroud had not separated. Cernan performed 2-hr EVA.							
Jul. 5	<i>Apollo-Saturn 203</i> (AS-203)	Launch vehicle development test. Orbited Saturn's S-IVB stage for new U.S. weight record—26535 kg.	Uprated Saturn I (ETR)	S	S	S	S	S
Jul. 18	<i>Gemini X GATV</i>	Gemini-Agena Target Vehicle for manned <i>Gemini X</i> rendezvous and docking.	Atlas-GATV (ETR)	S	S	S	S	S
Jul. 18	<i>Gemini X</i>	John W. Young and Michael Collins made first manned space rendezvous with 2 spacecraft— <i>Gemini X GATV</i> and <i>Gemini VIII GATV</i> . First use of another spacecraft to provide primary and secondary power for docked manned spacecraft. Two EVAs	Titan II (ETR)	S	S	S	S	S
Aug. 10	<i>Lunar Orbiter 1</i> (Lunar Orbiter A)	Lunar orbital probe. Went into lunar orbit Aug. 14; medium-resolution camera took good photos of Apollo landing sites, back of moon, and first view of earth from moon.	Atlas-Agena D (ETR)	S	P	S	S	S
Aug. 24	<i>Luna 11</i> (U.S.S.R.)	Orbit the moon, measure lunar radiation. Made observations and transmitted 137 times before batteries failed Oct. 1.	Not available	S	S	S	S	S

APPENDIX 4—FLIGHT SUMMARY—Continued

Date	Name	General Mission	Launch Vehicle, Site	Performance		
				Vehicle	Payload	Mission Results
<i>1966—continued</i>						
Aug. 25	Apollo-Saturn 202 (AS-202)	Third test, suborbital, of Up-rated Saturn I (Saturn IB) and second test of Apollo heat-shield. Service module was fired 4 times; command module was propelled into reentry at 32 000 km per hr.	Up-rated Saturn I (ETR)	S	S	S
Sep. 12	Gemini XI GATV (Gemini XI)	Gemini-Agena Target Vehicle for manned Gemini XI spacecraft.	Atlas-GATV (ETR)	S	S	S
Sep. 12	Gemini XI (Gemini XI)	Orbital manned space flight. Charles Conrad, Jr., and Richard F. Gordon, Jr., achieved rendezvous and docking on first revolution; set new manned space flight altitude record, 1370 kilometers.	Titan II (ETR)	S	S	S
Sep. 20	Surveyor 2 (Surveyor B)	Launched on good trajectory for lunar landing. Failure of 1 of 3 vernier engines to fire during midcourse maneuver caused spacecraft to spin. Crash-landed on the moon Sep. 22.	Atlas-Centaur (ETR)	S	U	U

Oct. 22	<i>Luna 12</i> (U.S.S.R.)	Orbited the moon, took TV photos of moon and scientific measurements of lunar radiation, meteoroids.	Not available	S	S	S	
Nov. 6	<i>Lunar Orbiter 2</i> (Lunar Orbiter B)	Lunar probe, orbital. By Nov. 25 had taken all planned medium- and high-resolution photos of 13 possible Apollo landing sites.	Atlas-Agena D (ETR)	S	S	S	
Nov. 11	<i>Gemini XII GATV</i> (Gemini XII)	Gemini-Agena Target Vehicle for final manned orbital Gemini space flight.	Atlas-GATV (ETR)	S	S	S	
Nov. 11	<i>Gemini XII</i> (Gemini XII)	James A. Lovell, Jr., and Edwin E. Aldrin, Jr., rendezvoused and docked with target vehicle. Aldrin performed 2 standup and 1 tethered EVA and work tasks in space.	Titan II (ETR)	S	S	S	
Dec. 21	<i>Luna 13</i> (U.S.S.R.)	Made 2d successful U.S.S.R. soft landing on moon, photographed lunar surface characteristics, measured lunar radiation.	Not available	S	S	S	
1967	Feb. 4	<i>Lunar Orbiter 3</i> (Lunar Orbiter C)	Lunar probe, orbital. Entered orbit Feb. 8, then close lunar orbit. Took 211 medium- and high-resolution photos of Apollo landing sites and lunar features.	Atlas-Agena B (ETR)	S	S	S

APPENDIX 4—FLIGHT SUMMARY—Continued

Date	Name	General Mission	Launch Vehicle, Site	Performance		
				Vehicle	Payload	Mission Results
<i>1967—continued</i>						
Apr. 17	<i>Surveyor 3</i> (<i>Surveyor C</i>)	Scientific lunar landing probe. Soft-landed on moon after 3 bounces. Transmitted 6315 detailed photos of lunar surface.	Atlas-Centaur (ETR)	S	S	S
Apr. 23	<i>Soyuz 1</i> (U.S.S.R.)	First Soviet manned space flight since Mar. 1966. Cosmonaut Vladimir M. Komarov was killed in crash landing after tumbling caused premature spacecraft reentry and parachute straps twisted on opening. First man to die in space flight.	Not available	S	U	U
May 4	<i>Lunar Orbiter 4</i> (<i>Lunar Orbiter D</i>)	Lunar photographic probe. Transmitted 163 high- and medium-resolution photos of lunar surface, including coverage of 99 percent of moon's front face and much of back face.	Atlas-Agena D (ETR)	S	S	S
Jul. 14	<i>Surveyor 4</i> (<i>Surveyor D</i>)	Scientific lunar landing probe. Trajectory was excellent but all communications were lost seconds before attempt at soft landing.	Atlas-Centaur (ETR)	S	U	U

Jul. 19	<i>Explorer 35</i> (IMP-E)	Traveled to moon on direct trajectory; on Jul. 21 retrorockets slowed spacecraft enough to permit lunar capture; went into elliptical lunar orbit, 7693 by 800 km; returned data on radiation at lunar distance.	Thrust-Augmented Thor-Delta (ETR)	S	S	S
Aug. 1	<i>Lunar Orbiter 5</i> (Lunar Orbiter E)	Lunar orbital probe, took 424 photos of lunar surface, filling gaps in lunar coverage; provided detailed coverage of 36 scientific-interest sites and 5 Apollo sites.	Atlas-Agena D (ETR)	S	S	S
Sep. 8	<i>Surveyor 5</i> (Surveyor E)	Scientific lunar landing probe. Soft-landed in lunar Sea of Tranquility. Transmitted 18 006 photos during first lunar day; soil test confirmed basaltic character of lunar soil, similar to earth's.	Atlas-Centaur (ETR)	S	S	S
Nov. 7	<i>Surveyor 6</i> (Surveyor F)	Scientific lunar landing probe. Soft-landed in Sinus Medii area, transmitted 30 065 TV photos during first lunar day. On Nov. 17 vernier engines were restarted and spacecraft lifted off lunar surface and landed 2.4 m away.	Atlas-Centaur (ETR)	S	S	S

APPENDIX 4—FLIGHT SUMMARY—Continued

Date	Name	General Mission	Launch Vehicle, Site	Performance		
				Vehicle	Payload	Mission Results
<i>1967—continued</i>						
Nov. 9	<i>Apollo 4</i> (AS-501)	Launch vehicle and spacecraft development. Launched into earth orbit; S-IVB stage fired again and lifted CSM to apogee of 18 089 km. Service propulsion system powered command module to reentry speed of 11 136 m per sec.	Saturn V (ETR)	S	S	S
<i>1968</i>						
Jan. 7	<i>Surveyor 7</i> (Surveyor G)	Scientific lunar landing probe. Soft-landed on moon Jan. 9. During first lunar day, transmitted 21 274 TV photos and operated 3 scientific experiments.	Atlas-Centaur (ETR)	S	S	S
Jan. 22	<i>Apollo 5</i> (AS-204)	Launch vehicle and spacecraft development. <i>Apollo 5</i> was launched into earth orbit; lunar module, in first flight test, separated and fired its ascent and descent engines several times.	Saturn IB (ETR)	S	S	S
Apr. 4	<i>Apollo 6</i> (AS-502)	Launch vehicle and spacecraft development. <i>Apollo 6</i> was launched into earth orbit.	Saturn V (ETR)	U	Unknown	U

			Entered lunar orbit Apr. 10
Apr. 7	<i>Luna 14</i> (U.S.S.R.)	Three of primary objectives were met but mission was not a success. CM was recovered. Study near-lunar space.	
Apr. 27	Reentry F	Suborbital 6069-m-per-sec re-entry test. Reentry F reentered at 6020 m-per-sec.	S S S
Aug. 22	RAM C-II	Suborbital reentry probe. RAM C-II reentered at 27 400 km per hr, measured electrons and ions built up around spacecraft.	S S S
Oct. 11	<i>Apollo 7</i> (AS-205)	First manned Apollo flight, manned by Walter M. Schirra, Jr., Donn F. Eisele, and R. Walter Cunningham; confirmed operation of all major systems except lunar module. First live commercial TV from space. Earth-orbital mission landed during 164th revolution on Oct. 22.	S S S
Oct. 25	<i>Soyuz 2</i> (U.S.S.R.)	Target for joint experiments with manned spacecraft.	S S S
Oct. 26	<i>Soyuz 3</i> (U.S.S.R.)	Perfect rendezvous techniques in orbit and perform joint	S S S

APPENDIX 4—FLIGHT SUMMARY—Continued

Date	Name	General Mission	Launch Vehicle, Site	Performance		
				Vehicle	Payload	Mission Results

1968—continued

experiments with target vehicle. Automatic maneuvering brought spacecraft within 200 m of Soyuz 2 on first orbit. Cosmonaut Georgy T. Beregovoy later made manual maneuvers. No docking. Soft-landed Oct. 30 after 64 orbits.

Dec. 21 *Apollo 8*
(AS-503)

After 2 revolutions in earth orbit, *Apollo 8*'s 3d-stage was fired to attain escape velocity and insert spacecraft on lunar trajectory. Manned Spacecraft with Frank Borman, James A. Lovell, Jr., and William A. Anders, entered lunar orbit Dec. 24, stayed for 10 orbits; transmitted live TV of lunar surface to earth; fired spacecraft motor to lunar escape speed Dec. 25; reentered earth's atmosphere Dec. 27. First manned Saturn V flight, first men to escape earth's gravity, first men to orbit moon.

Saturn V
(ETR) S S S

1969	Jan. 14 <i>Soyuz 4</i> (U.S.S.R.)	Perform tests between 2 manned orbiting spacecraft. Cosmonaut Vladimir A. Shatalov switched to manual control and rendezvoused and docked with <i>Soyuz 5</i> (launched Jan. 15). Link-up covered on live TV. Landed safely Jan. 17 with 3-man crew.	Not available	S	S
	Jan. 15 <i>Soyuz 5</i> (U.S.S.R.)	Launched 1 day after <i>Soyuz 4</i> with cosmonauts Yevegeny V. Khrunov, Boris V. Volynov, and Aleksey S. Yeliseyev aboard. Rendezvoused with <i>Soyuz 4</i> and docked during 18th orbit. Khrunov and Yeliseyev completed first manned transfer (to <i>Soyuz 4</i>) after 1-hour EVA. <i>Soyuz 5</i> , with Volynov aboard, landed safely Jan. 18.	Not available	S	S
	Mar. 3 <i>Apollo 9</i> (AS-504)	Earth-orbital manned Apollo flight by James A. McDivitt, David R. Scott, and Russell L. Schweickart. First manned	Saturn V (KSC)	S	S

APPENDIX 4—FLIGHT SUMMARY—Continued

Date	Name	General Mission	Launch Vehicle, Site	Performance		
				Vehicle	Payload	Mission Results
<i>1969—continued</i>						
		testing of complete Apollo Spacecraft; first manned testing of LM, including rendezvous with CSM; 37-min. EVA by Schweikart; simulated LM landing and takeoff from lunar surface. Landed and recovered Mar. 13.				
May 18	<i>Apollo 10</i> (AS-505)	Lunar-orbital manned Apollo flight by Thomas P. Stafford, Eugene A. Cernan, and John W. Young. After insertion into lunar orbit, crew transposed CSM and docked with LM. SPS fired 76 hrs into mission to insert spacecraft into lunar orbit; second firing circularized orbit at about 100 hrs. Stafford and Cernan entered LM, undocked from CSM and briefly flew stationkeeping exercise. LM flew over Apollo 11 landing site 2, and simulated lunar landing by descending to within 14 300 meters of lunar surface. After 8-hr separation,	Saturn V (KSC)	S	S	S

LM docked with CSM, crew transferred, and LM ascent stage was jettisoned. After 61 hrs in lunar orbit, spacecraft was injected into transearth trajectory. One midcourse correction was required; CM landed in Pacific on May 26 and crew and spacecraft were safely recovered.

Not available
Impacted on moon
Jul. 16

Make further scientific exploration of moon and near lunar space.

Jul. 13 *Luna 15*
(U.S.S.R.)

First manned lunar landing mission, crewed by astronauts Neil A. Armstrong, Edwin E. Aldrin, Jr., and Michael Collins. After LM checkout in lunar orbit, Armstrong and Aldrin undocked LM from CSM and descended to land on Sea of Tranquility at 4:18 p.m. EDT Jul. 20. Armstrong took man's first step on moon's surface at 10:56 p.m. and Aldrin followed at 11:15 p.m. Samples were collected, several experiments deployed, and LM lifted off from moon at 1:54 p.m. EDT Jul. 21. Command module and crew landed in Pacific Jul. 24.

Saturn V
(KSC)

S

S

S

Not available

Jul. 16 *Apollo 11*
(AS-506)

APPENDIX 4—FLIGHT SUMMARY—Continued

Date	Name	General Mission	Launch Vehicle, Site	Performance		
				Vehicle	Payload	Mission Results
<i>1969-continued</i>						
Oct. 11	<i>Soyuz 6</i> (U.S.S.R.)	Launched carrying cosmonauts Georgy S. Shonin and Valery Kubasov. Tested welding techniques in a depressurized spacecraft chamber. Hovered nearby as <i>Soyuz 7</i> and <i>Soyez 8</i> made rendezvous maneuvers. Soft-landed in U.S.S.R. Oct. 16.	Not available	S	S	S
Oct. 12	<i>Soyuz 7</i> (U.S.S.R.)	Launched with cosmonauts Vladislav N. Volkov, Anatoly V. Filipchenko, and Viktor V. Gorbatko aboard. Performed rendezvous maneuvers with <i>Soyuz 8</i> , approaching within 460 m of spacecraft. Soft-landed in U.S.S.R. Oct. 17.	Not available	S	S	S
Oct. 13	<i>Soyuz 8</i> (U.S.S.R.)	Third Soviet manned spacecraft launched in 3 days, with cosmonaut crew of Vladimir A. Shatalov and Aleksey S. Yeliseyev. Rendezvoused with <i>Soyuz 7</i> and together with <i>Soyuz 6</i> tested complex system of controlling simultaneous	Not available	S	S	S

group flight of 3 spacecraft and maneuvering to solve number of problems in developing piloted space system. Soft-landed safely in U.S.S.R. Oct. 18.

S

S

S

Saturn V
(KSC)

Nov. 14 *Apollo 12*
(AS-507)

Second manned lunar landing mission with crew, Charles Conrad, Jr., Richard F. Gordon, Jr., and Alan L. Bean. Experienced momentary power loss 36 secs after liftoff, after electrical potential discharge from clouds passed through space vehicle to ground. Power was quickly restored. Conrad and Bean undocked LM, descended, and touched down in Ocean of Storms Nov. 19 at 1:55 a.m. EST, 180 meters from *Surveyor 3* spacecraft. They performed two EVAs, obtained samples, erected experiments, and deployed ALSEP. Retrieved soil scoop from *Surveyor 3*. Total lunar stay time 31 hrs 31 min. LM liftoff from moon at 9:26 a.m. EST Nov. 20. Command module and crew landed safely in Pacific Nov. 24.

APPENDIX 4—FLIGHT SUMMARY—Continued

Date	Name	General Mission	Launch Vehicle, Site	Performance		
				Vehicle	Payload	Mission Results
1970						
Apr. 11	<i>Apollo 13</i> (AS-508)	Third planned lunar landing mission was launched successfully with James A. Lovell, Jr., John L. Swigert, Jr., and Fred W. Haise, Jr., aboard. Mission was aborted 56 hrs into flight toward moon because of SM oxygen tank rupture. LM "Lifeboat" emergency plan was put into effect; LM descent propulsion system placed spacecraft in free-return trajectory around moon. Command module and crew safely landed in Pacific Apr. 17.	Saturn V (KSC)	S	P	U
Jun. 2	<i>Soyuz 9</i> (U.S.S.R.)	<i>Soyuz 9</i> with crew of cosmonauts Andrian G. Nikolayev and Vitaly I. Sevastyanov set new world endurance record for longest manned space flight—17 days 16 hrs 59 min. Soft-landed in U.S.S.R. on Jun. 19.	Not available	S	S	S
Sep. 12	<i>Luna 16</i> (U.S.S.R.)	First unmanned spacecraft to land on moon and return to	Not available	S	S	S

earth with lunar samples. Analyses of Sea of Fertility samples indicated same relative abundance of major elements as *Apollo 12* Ocean of Storms samples. Returned to earth Sep. 24.

Sep. 30 RAM C-III Scout (WS) S S S S

Suborbital reentry probe. Reentered at 7.6 km per sec to compare effectiveness of liquid electrophilic (Freon) with water in alleviating radio blackout during reentry.

Nov. 10 *Luna 17*
(U.S.S.R.)

Not available S S S S

Soft-landed in moon's Sea of Rains Nov. 16 and released *Lunokhod 1*, self-propelled vehicle resembling large potbellied tub, about size of small auto, with 8 spoked wheels, powered by solar energy and batteries. Automatic lunar explorer—equipped with scientific apparatus, instruments, control system, radio, and TV—operated during lunar days and hibernated during lunar nights. By May 22, 1971, it had logged 8458 m and explored 400 000 sq m.

APPENDIX 4—FLIGHT SUMMARY—Continued

Date	Name	General Mission	Launch Vehicle, Site	Performance		
				Vehicle	Payload	Mission Results
1971						
Jan. 31	<i>Apollo 14</i> (AS-509)	Third successful manned lunar landing mission. Alan B. Shepard, Jr., Stuart A. Roosa, and Edgar D. Mitchell composed crew. Shepard and Mitchell landed LM at Fra Mauro site Feb. 5. Conducted two EVAs, deployed ALSEP, and used mobile equipment transporter to obtain 43 kg of lunar samples. LM lifted off Feb. 6 and command module and crew splashed down in Pacific Feb. 9.	Saturn V (KSC)	S	S	S
Apr. 19	<i>Salyut 1</i> (U.S.S.R.)	World's first manned space laboratory. Placed in orbit as working area for 2 Soviet cosmonaut crews. Reentered Oct. 11 after nearly 6 mos in orbit.	Not available	S	S	S
Apr. 23	<i>Soyuz 10</i> (U.S.S.R.)	Cosmonauts Vladimir A. Shatalov, Aleksey S. Yeliseyev, and Nikolay N. Rukavishnikov docked Apr. 24 with unmanned <i>Salyut 1</i> for 5½ hrs. No crew transfer. After separation,	Not available	S	S	S

<p>circled <i>Salyut 1</i> for 1 hr; taking pictures. Safely landed Apr. 25 in U.S.S.R.</p>						
<p>Jun. 6</p>	<p><i>Soyuz 11</i> (U.S.S.R.)</p>	<p>Spacecraft carried cosmonauts Georgy T. Dobrovolsky, Vladislav N. Volkov, and Viktor I. Patsayev docked with unmanned <i>Salyut 1</i> Jun. 7. Crew transferred and Salyut-Soyuz station became first manned orbiting laboratory in space. Crew conducted experiments, made astronomical observations, transmitted live TV, reared tadpoles, grew vegetables and took photos. Crew transferred to <i>Soyuz 10</i> and undocked Jun. 29. At 1:35 a.m. June 30 Moscow time, spacecraft's braking engine fired. At end of firing, communication with crew ceased. After normal automatic landing rescue helicopter team found <i>Soyuz 11</i> crew dead in spacecraft. Crew had died when accidental triggering of exhaust valve decompressed work compartment.</p>	<p>Not available</p>	<p>S</p>	<p>U</p>	<p>U</p>
<p>Jul. 26</p>	<p><i>Apollo 15</i> (AS-510)</p>	<p>Launched with crew of David R. Scott, Alfred M. Worden, and James B. Irwin. Scott and Irwin landed LM on lunar</p>	<p>Saturn V (KSC)</p>	<p>S</p>	<p>S</p>	<p>S</p>

APPENDIX 4—FLIGHT SUMMARY—Continued

Date	Name	General Mission	Launch Vehicle, Site	Performance		
				Vehicle	Payload	Mission Results
<i>1971-continued</i>						
		surface in Hadley-Apennine region Jul. 30. Performed 3 EVAs, deployed ALSEP, obtained 77 kg of lunar samples, took photos, explored Hadley Rille, and drove lunar roving vehicle first time. LM lifted off from moon Aug. 2. After LM-CSM docking, subsatellite was launched into lunar orbit from CSM. CM landed in Pacific Aug. 7.				
	and <i>Apollo 15</i> <i>Subsatellite</i>				S	S
Sep. 2	<i>Luna 18</i> (U.S.S.R.)	Unmanned lunar probe entered lunar orbit Sep. 7. Made 54 revolutions of moon before landing attempted near Sea of Fertility. Communication ceased upon landing. Believed to have crash-landed.	Not available	S	U	U

Sep. 28 <i>Luna 19</i> (U.S.S.R.)	Unmanned lunar probe entered lunar orbit Oct. 3. All systems operating normally; conducted geophysical research of moon's gravitational field and relayed photos of lunar surface.	Not available	S	S	S
1972					
Feb. 14 <i>Luna 20</i> (U.S.S.R.)	Unmanned spacecraft entered lunar orbit Feb. 18 and landed between moon's Sea of Fertility and Sea of Crises Feb. 21. Earth-operated drilling rig penetrated lunar surface to 35 cm; samples were obtained and transferred to container in return capsule and hermetically sealed. Luna 20 remained on moon 21 hrs 39 min, lifted off Feb. 22, and returned to earth Feb. 24. Total time of mission, 11 days and 16 hrs. Analysis of lunar samples indicated area consisted primarily of anorthosite. Findings contrasted with <i>Luna 16</i> Sea of Fertility samples, which were primarily basaltic rock.	Not available	S	S	S
Apr. 16 <i>Apollo 16</i> (AS-511)	Sixth manned lunar landing mission was launched with John W. Young, Thomas L. Mattingly II, and Charles M. Duke, Jr., as crew. Spacecraft entered lunar orbit Apr. 19. LM undocked and landed in the	Saturn V (KSC)	S	S	S

APPENDIX 4—FLIGHT SUMMARY—Continued

Date	Name	General Mission	Launch Vehicle, Site	Performance	
				Vehicle	Payload

1972—continued

Descartes region of moon at 9:23 p.m. EST the following day. During lunar stay time of 71 hrs 14 min, Young and Duke completed EVA periods; drove lunar roving vehicle (LRV); deployed ALSEP (accidentally breaking heat flow experiment); explored Survey Ridge, Stone Mountain, South Ray Crater, North Ray Crater, and 2 other sites. Live color TV was transmitted during all EVAs. Ascent stage of the LM lifted off from moon Apr. 24 with 96.6 kg of samples and with live TV coverage from LRV camera.

After docking with CSM and crew and cargo transfer, LM ascent stage was jettisoned, began tumbling, and went into lunar orbit rather than impacting lunar surface. Scientific subsatellite was launched into lunar orbit and CSM was inserted into trajectory for

earth. During return trip Mattingly performed 1-hr 24-min EVA to retrieve film from SM camera. CM landed in Pacific Apr. 27 and was recovered by U.S.S. *Ticonderoga*.

*Apollo 16
Subsatellite*

Scientific subsatellite was spring-ejected from the SM's scientific instrument module bay on Apr. 24. Shaping burn to optimize its orbit was not performed, because of CSM engine problems. Subsatellite's orbit decreased and spacecraft impacted moon May 29 after 425 revolutions.

Dec. 7 *Apollo 17*
(AS-512)

Final Apollo mission was launched with crew of Eugene A. Cernan, Ronald E. Evans, and Harrison H. Schmitt. CSM/LM entered lunar orbit Dec. 10. LM undocked Dec. 11 and touched down in Taurus-Littrow area of moon at 2:55 p.m. During stay time of 74 hrs 59 min 39 secs, Cernan and Schmitt performed 3 EVAs. They drove lunar roving vehicle to Sterno Crater; deployed ALSEP; explored additional stations. Live color TV was transmitted during all 3 EVAs and liftoff from moon Dec. 14.

Saturn V
(KSC)

S P

S S

APPENDIX 4—FLIGHT SUMMARY—Concluded

Date	Name	General Mission	Launch Vehicle, Site	Performance	
				Vehicle	Payload
<p>1972—continued</p> <p>During stay astronauts collected 115 kg of lunar samples and drove LRV about 35 km. After CSM/LM docking and crew and cargo transfer, ascent stage was jettisoned to impact moon. Impact was recorded by four <i>Apollo 17</i> geophones and <i>Apollo 12, 14, 15, and 16</i> ALSEPs. During coast to earth, Evans performed 1-hr 7-min EVA to retrieve film from SM camera. Spacecraft splashed down in mid-Pacific at 2:25 p.m. EST Dec. 19 and was recovered by U.S.S. <i>Ticonderoga</i>. Splashdown ended Apollo manned space flight program.</p>					

SOURCE: *Astronautics and Aeronautics: Chronology of Science, Technology, and Policy*, annual volumes 1966 through 1972 (NASA SP-4007, 1967; SP-4008, 1968; SP-4010, 1969; SP-4014, 1970; SP-4015, 1972; SP-4016, 1972; SP-4017, 1975), Appendixes A, B, and C, and 1973 (NASA SP-4018), p. 282.

APPENDIX 5—PRIMARY APOLLO FLIGHT OBJECTIVES

[Apollo-Saturn 201 through *Apollo 17*]

Apollo-Saturn 201 (February 26, 1966)

Primary Objectives (all achieved)

1. Obtain flight information on the structural integrity and compatibility of the launch vehicle and spacecraft and confirm launch loads.
2. Test the separation of:
 - a. S-IVB stage, instrument unit (IU) and spacecraft from S-IB stage.
 - b. Launch escape systems (LES) and boost protective cover from command and service modules (CSM) and launch vehicle.
 - c. CSM from S-IVB stage, IU, and service module LEM adapter (SLA).
 - d. Command module (CM) from service module (SM).
3. Obtain flight operation information on the following subsystems:
 - a. Launch vehicle—propulsion, guidance and control, and electrical systems.
 - b. Spacecraft—CM heatshield (adequacy for entry from low earth orbit); service propulsion system (SPS) (including restart); Environmental control system (ECS) (pressure and temperature control); communications (partial); CM reaction control system (RCS); SM RCS; stabilization control system (SCS); earth landing system (ELS); electrical power system (EPS), partial.
4. Evaluate performance of the space vehicle emergency detection system (EDS) in an open-loop configuration.
5. Evaluate the CM heatshield at a heating rate of approximately 200 BTU/ft²/sec during entry at approximately 9 km/sec.
6. Demonstrate the mission support facilities and operations required for launch, mission conduct, and CM recovery.
7. Recover the CM.

Apollo-Saturn 203 (July 5, 1966)

Primary Objectives (all achieved)

1. Evaluate performance of the S-IVB/IU stage under orbital conditions to obtain flight information on:
 - a. Venting and chill-down systems.
 - b. Fluid dynamics and heat transfer to propellant tanks.
 - c. Attitude and thermal control systems.
 - d. Launch vehicle guidance.
 - e. Checkout in orbit.

Apollo-Saturn 202 (August 25, 1966)

Primary Objectives (all achieved)

1. Evaluate the CM heatshield at a high heating load.
2. Obtain further launch vehicle and spacecraft information on:
 - a. Structural integrity and compatibility.
 - b. Flight loads.
 - c. Stage separation.
 - d. Subsystem operations.
 - e. Emergency detection system operation.

Apollo 4 (AS-501) (November 9, 1967)

Primary objectives (all achieved)

Launch vehicle:

1. Demonstrate the S-IVB-stage restart capability.
2. Demonstrate the adequacy of the S-IVB continuous vent system while in earth orbit.
3. Demonstrate the capability of the S-IVB auxiliary propulsion system during S-IVB powered flight and orbital coast periods to maintain attitude control and perform required maneuvers.
4. Demonstrate the S-IVB-stage propulsion system, including the propellant management systems, and determine inflight system performance parameters.
5. Demonstrate the S-II-stage propulsion system, including programmed mixture ratio shift and the propellant management system, and determine inflight performance parameters.
6. Demonstrate the S-IC-stage propulsion system, and determine inflight system performance parameters.
7. Demonstrate the S-IC/S-II dual-plane separation.
8. Demonstrate the S-II/S-IVB separation.
9. Demonstrate the mission support capability required for launch and mission operations to high post-injection altitudes.
10. Demonstrate structural and thermal integrity of the launch vehicle throughout powered and coasting flight and determine inflight structural loads and dynamic characteristics.
11. Determine inflight launch vehicle internal environment.
12. Demonstrate the launch vehicle guidance and control system during S-IC, S-II, and S-IVB powered flight, achieve guidance cutoff, and evaluate system accuracy.
13. Demonstrate launch vehicle sequencing system.
14. Evaluate the performance of the emergency detection system in an open-loop configuration.
15. Demonstrate compatibility of the launch vehicle and spacecraft.

16. Verify prelaunch and launch support equipment compatibility with launch vehicle and spacecraft systems.

Spacecraft:

1. Demonstrate CSM/SLA/LTA/Saturn V structural compatibility and determine spacecraft loads in a Saturn V launch environment.
2. Determine the dynamic and thermal responses of the SLA/CSM structure in the Saturn V launch environment.
3. Determine the force inputs to the simulated LM from the SLA at the spacecraft attachment structure in a Saturn V launch environment.
4. Obtain data on the acoustic and thermal environment of the SLA/simulated LM interface during a Saturn V launch.
5. Determine vibration response of LM descent-stage engine and propellant tanks in a Saturn V launch environment.
6. Evaluate the thermal and structural performance of the Block II thermal protection system, including effects of cold soak and maximum thermal gradient when subjected to the combination of a high heat load and a high heating rate representative of lunar return entry.
7. Demonstrate an SPS no-ullage start.
8. Determine performance of the SPS during a long-duration burn.
9. Verify the performance of the SM/RCS thermal control subsystem and engine thermal response in the deep space environment.
10. Verify the thermal design adequacy of the CM/RCS thrusters and extensions during simulated lunar return entry.
11. Evaluate the thermal performance of a gap and seal configuration simulating the unified crew hatch design for heating conditions anticipated during lunar return entry.
12. Verify operation of the heat rejection system throughout the mission.
13. Evaluate the performance of the spacecraft emergency detection subsystem (EDS) in the open-loop configuration.
14. Demonstrate the performance of CSM/MSFN S-band communications.
15. Measure the integrated skin and depth radiation dose within the command module up to an altitude of at least 3700 km.

Apollo 5 (AS-204/LM-1) (January 22, 1968)

Primary Objectives (all achieved)

1. Verify operation of the following LM subsystems: ascent propulsion system and descent propulsion system (including restart), and structure.
2. Evaluate LM staging.
3. Evaluate the S-IVB/IU orbital performance.

Apollo 6 (AS-502) (April 4, 1968)

Primary Objectives

1. Demonstrate the structural and thermal integrity and compatibility of the launch vehicle and spacecraft, confirm launch loads and dynamic characteristics (partially accomplished).
2. Demonstrate separation of:
 - a. S-II from S-IC (dual plane).
 - b. S-IVB from S-II.
(accomplished)
3. Verify operation of the following launch vehicle subsystems: propulsion (including S-IVB restart), guidance and control (optimum injection), and electrical system (partially accomplished).
4. Evaluate performance of the space vehicle EDS in a closed-loop configuration (accomplished).
5. Demonstrate mission support facilities and operations required for launch, mission conduct, and CM recovery (accomplished).

Apollo 7 (AS-205) (October 11, 1968)

Primary Objectives (all achieved)

1. Demonstrate CSM/crew performance.
2. Demonstrate crew-space vehicle-mission support facilities performance during a manned CSM mission.
3. Demonstrate CSM rendezvous capability.

Apollo 8 (AS-503) (December 21, 1968)

Primary Objectives (all achieved)

1. Demonstrate crew-space vehicle-mission support facilities performance during a manned Saturn V mission with CSM.
2. Demonstrate performance of nominal and selected backup lunar orbit rendezvous (LOR) mission activities, including:
 - a. Translunar injection.
 - b. CSM navigation, communications, and midcourse corrections.
 - c. CSM consumables assessment and passive thermal control.

Apollo 9 (AS-504) (March 3, 1969)

Primary Objectives (all achieved)

1. Demonstrate crew-space vehicle-mission support facilities performance during a manned Saturn V mission with CSM and LM.
2. Demonstrate LM/crew performance.
3. Demonstrate performance of nominal and selected backup LOR mission activities, including:

- a. Transposition, docking, LM withdrawal.
 - b. Intervehicular crew transfer.
 - c. Extravehicular capability.
 - d. SPS and DPS burns.
 - e. LM-active rendezvous and docking.
4. CSM/LM consumables assessment.

Apollo 10 (AS-505) May 18, 1969)

Primary Objectives (all achieved)

1. Demonstrate crew-space vehicle-mission support facilities performance during a manned lunar mission with CSM and LM.
2. Evaluate LM performance in the cislunar and lunar environment.

Apollo 11 (AS-506) (July 16, 1969)

Primary Objective (accomplished)

Perform a manned lunar landing and return.

Detailed Objectives and Experiments

1. Collect a contingency, sample (accomplished).
2. Egress from the LM to the lunar surface, perform lunar surface EVA operations, and ingress into the LM from the lunar surface (accomplished).
3. Perform lunar surface operations with the EMU (accomplished).
4. Obtain data on effects of DPS and RCS plume impingement on the LM and obtain data on the performance of the LM landing gear and descent engine skirt after touchdown (accomplished).
5. Obtain data on the lunar surface characteristics from the effects of the LM landing (accomplished).
6. Collect lunar bulk samples (accomplished).
7. Determine the position of the LM on the lunar surface (accomplished).
8. Obtain data on the effects of illumination and contrast conditions on crew visual perception (accomplished).
9. Demonstrate procedures and hardware used to prevent back contamination of the earth's biosphere (accomplished).
10. Deploy the Early Apollo Scientific Experiments Package (EASEP), which included:
 - a. S031, Passive Seismic Experiment (accomplished).
 - b. S078, Laser Ranging Retro-Reflector (accomplished).
11. Deploy and retrieve the Solar Wind Composition Experiment, S080 (accomplished).
12. Perform Cosmic Ray Detector Experiment (helmet portion), S151 (accomplished).
13. Perform Lunar Field Geology, S059 (partially accomplished).

14. Obtain television coverage during the lunar stay period (accomplished).
15. Obtain photographic coverage during the lunar stay period (accomplished).

Apollo 12 (AS-507) (November 14, 1969)

Primary Objectives (all achieved)

1. Perform selenological inspection, survey, and sampling in a mare area.
2. Deploy and activate the Apollo Lunar Surface Experiments Package (ALSEP).
3. Develop techniques for a point landing capability.
4. Develop man's capability to work in the lunar environment.
5. Obtain photographs of candidate exploration sites.

Detailed Principal Objectives and Experiments (all achieved)

1. Collect a contingency sample.
2. Perform lunar surface EVA operations.
3. Deploy ALSEP I, which included:
 - a. S031, Passive Seismic Experiment.
 - b. S034, Lunar Surface Magnetometer Experiment.
 - c. S035, Solar Wind Spectrometer Experiment.
 - d. S036, Suprathermal Ion Detector Experiment.
 - e. S058, Cold Cathode Ionization Gauge Experiment.
 - f. M515, Lunar Dust Detector.
4. Collect selected samples.
5. Recharge the portable life support systems.
6. Perform Lunar Field Geology, S059.
7. Obtain photographic coverage of candidate exploration sites.

Apollo 13 (AS-508) (April 11, 1970)

Primary Objectives (none achieved)

1. Perform selenological inspection, survey, and sampling of materials in a preselected region of the Fra Mauro formation.
2. Deploy and activate an Apollo Lunar Surface Experiments Package (ALSEP).
3. Develop man's capability to work in the lunar environment.
4. Obtain photographs of candidate exploration sites.

Apollo 14 (AS-509) (January 31, 1971)

Primary Objectives (all achieved)

1. Perform selenological inspection, survey, and sampling of materials in a preselected region of the Fra Mauro formation.
2. Deploy and activate ALSEP.
3. Develop man's capability to work in the lunar environment.
4. Obtain photographs of candidate exploration sites.

Apollo 15 (AS-510) (July 26, 1971)

Primary Objectives (all achieved)

1. Perform selenological inspection, survey, and sampling of materials and surface features in a preselected area of the Hadley-Apennine region.
2. Emplace and activate surface experiments.
3. Evaluate the capability of the Apollo equipment to provide extended lunar surface stay time, increased EVA operations, and surface mobility.
4. Conduct inflight experiments and photographic tasks from lunar orbit.

Apollo 16 (AS-511) (April 16, 1972)

Primary Objectives (all achieved)

1. Perform selenological inspection, survey, and sampling of material and surface features in a preselected area of the Descartes region.
2. Emplace and activate surface experiments.
3. Conduct inflight experiments and photographic tasks.

Apollo 17 (AS-512) (December 7, 1972)

Primary Objectives (all achieved)

1. Perform selenological inspection, survey, and sampling of material and surface features in a preselected area of the Taurus-Littrow region.
2. Emplace and activate surface experiments.
3. Conduct inflight experiments and photographic tasks.

APPENDIX 6—CREWS AND SUPPORT FOR MANNED APOLLO FLIGHTS

[Compiled by Sally D. Gates, History Office, JSC,
with Cyril E. Baker, Astronaut Office, JSC.]

<i>Apollo 7:</i>	Prime crew:	Schirra	Eisele	Cunningham	
	Backup:	Stafford	Young	Cernan	
	Support:	Evans	Swigert	Pogue	
	CapComs:	Stafford Swigert	Evans Young	Pogue Cernan	
<i>Apollo 8:</i>	Prime crew:	Borman	Lovell	Anders	
	Backup:	Armstrong	Aldrin	Haise	
	Support:	Brand	Mattingly	Carr	
	CapComs:	Collins Armstrong	Mattingly Aldrin	Carr Brand Haise	
<i>Apollo 9:</i>	Prime crew:	McDivitt	Scott	Schweickart	
	Backup:	Bean	Conrad	Gordon	
	Support:	Lousma	Mitchell	Worden	
	CapComs:	Roosa Conrad	Evans Gordon	Worden Bean	
<i>Apollo 10:</i>	Prime crew:	Stafford	Young	Cernan	
	Backup:	Cooper	Eisele	Mitchell	
	Support:	Engle	Irwin	Duke	
	CapComs:	Duke McCandless	Engle	Lousma	
<i>Apollo 11:</i>	Prime crew:	Armstrong	Collins	Aldrin	
	Backup:	Lovell	Anders	Haise	
	Support:	Mattingly	Evans	Pogue	Swigert
	CapComs:	Duke Lovell Haise Schmitt	Evans Anders Lind	McCandless Mattingly Garriott	
<i>Apollo 12:</i>	Prime crew:	Conrad	Gordon	Bean	
	Backup:	Scott	Irwin	Worden	
	Support:	Carr	Weitz	Gibson	
	CapComs:	Carr Scott Warren*	Gibson Worden Rippey*	Weitz Irwin Lewis*	Lind Wash*

APPENDIX 6

<i>Apollo 13:</i>	Prime crew:	Lovell	Swigert**	Haise
	Backup:	Young	Swigert	Duke
	Support:	Lousma	Brand	Pogue
	CapComs:	Kerwin Young	Brand Mattingly	Lousma
<i>Apollo 14:</i>	Prime crew:	Shepard	Roosa	Mitchell
	Backup:	Cernan	Evans	Engle
	Support:	McCandless Chapman	Pogue	Fullerton
	CapComs:	Fullerton Evans	McCandless	Haise
<i>Apollo 15:</i>	Prime crew:	Scott	Worden	Irwin
	Backup:	Gordon	Brand	Schmitt
	Support:	Henize	Allen	Parker
	CapComs:	Allen Mitchell Shepard	Fullerton Parker Gordon	Henize Schmitt Brand
	<i>Apollo 16:</i>	Prime crew:	Young	Mattingly
Backup:		Haise	Roosa	Mitchell
Support:		Peterson Chapman	England	Hartsfield
CapComs:		Peterson Haise Hartsfield	Fullerton Roosa England	Irwin Mitchell Overmyer
<i>Apollo 17:</i>		Prime crew:	Cernan	Evans
	Backup:	Young	Roosa	Duke
	Support:	Overmyer	Parker	Fullerton
	CapComs:	Fullerton Allen Duke	Overmyer Shepard Roosa	Parker Mattingly Young

NOTE: CapCom (capsule communicator) assignments are listed as they appeared in the manning documents (by shift), not as they might have been heard in chronological sequence during flight.

*On this four-shift flight, Dickie K. Warren, James O. Rippey, James L. Lewis, and Michael R. Wash were backup CapComs. This was the first time in the American manned space flight program that this position was filled by non-astronaut personnel.

**Swigert moved from the backup to the prime crew at the last minute, when command module pilot Mattingly was exposed to a contagious disease.

SOURCE: Mission reports, news releases, *NASA Astronauts* (NASA EP-34, Washington, 1967), and manning documents issued before each mission by the JSC Flight Operations Directorate and written, for the most part, by Cecil E. Dorsey.

APPENDIX 7—FUNDING

[Compiled by F. B. Hopson,
Administrative and Program Support Directorate, NASA]

Fiscal Year	Funding Breakdown (dollars in thousands)		
<i>1966</i>			
Original budget request—no supplemental for prior fiscal year	NASA:	\$4 575 900	Command and service modules: \$ 615 000
	Apollo:	2 997 385	
Fiscal budget appropriation—no supplemental for prior fiscal year	NASA:	4 511 644	Guidance and navigation: 115 000
	Apollo:	2 967 385	Integration, reliability, and checkout: 34 400
			Spacecraft support: 95 400
			Saturn I: 800
			Saturn IB: 274 185
			Saturn V: 1 177 320
			Engine development: 134 095
			Apollo mission support: 210 385
<i>1967</i>			
Original budget request	NASA:	\$4 246 600	Command and service modules: \$ 560 400
	Apollo:	2 974 200	
Fiscal budget appropriation	NASA:	4 175 100	Guidance and navigation: 76 654
	Apollo:	2 916 200	Integration, reliability, and checkout: 29 975
			Spacecraft support: 110 771
			Saturn IB: 236 600
			Saturn V: 1 135 600
			Engine development: 49 800
			Apollo mission support: 243 900
<i>1968</i>			
Original budget request including Fiscal Year 1967 supplemental	NASA:	\$4 324 500	Command and service modules: \$ 455 300
	Apollo:	2 606 500	
			Guidance and navigation: 113 000

APPENDIX 7

APPENDIX 7—FUNDING—Continued

Fiscal Year		Funding Breakdown (dollars in thousands)		
Fiscal budget appropriation including Fiscal Year 1967 supplemental	NASA:	3 970 600	Integration, reliability,	
	Apollo:	2 556 000	and checkout:	66 600
			Spacecraft support:	60 500
			Saturn IB:	146 600
			Saturn V:	998 900
			Engine development:	18 700
		Apollo mission support:	296 800	
<i>1969</i>				
Original budget request	NASA:	\$3 677 200	Command and service	
	Apollo:	2 038 800	modules:	\$ 346 000
			Lunar excursion module:	326 000
Fiscal budget appropriation	NASA:	3 193 559	Guidance and navigation:	43 900
	Apollo:	2 025 000	Integration, reliability,	
			and checkout:	65 100
			Spacecraft support:	121 800
			Saturn IB:	41 347
			Saturn V:	534 453
		Manned Space Flight Operations:	546 400	
<i>1970</i>				
Original budget request including Fiscal Year 1969 reserve	NASA:	\$3 168 900	Command and service	
	Apollo:	1 651 100	modules:	\$ 282 821
			Lunar excursion module:	231 433
Fiscal budget appropriation including Fiscal Year 1969 reserve	NASA:	3 113 765	Guidance and navigation:	33 866
	Apollo:	1 686 145	Science payloads:	60 094
			Spacecraft support:	170 764
			Saturn V:	484 439
			Manned Space Flight Operations:	422 728
<i>1971</i>				
Original budget request	NASA:	\$2 606 100	Flight modules:	\$ 245 542
	Apollo:	956 500	Science payloads:	106 194
			Ground support:	46 411
Fiscal budget appropriation	NASA:	2 555 000	Saturn V:	189 059
	Apollo:	913 669	Manned Space Flight Operations:	314 963
			Advance development:	11 500

APPENDIX 7—FUNDING—*Concluded*

Fiscal Year		Funding Breakdown (dollars in thousands)		
<i>1972</i>				
Original budget request	NASA:	\$2 517 700	Flight modules:	\$ 55 033
	Apollo:	612 200	Science payloads:	52 100
Fiscal budget appropriation	NASA:	2 507 700	Ground support:	31 659
			Saturn V:	142 458
	Apollo:	601 200	Manned Space Flight Operations:	307 450
			Advance development:	12 500
<i>1973</i>				
Original budget request	NASA:	\$2 600 900	Spacecraft:	\$ 50 400
	Apollo:	128 700	Saturn V:	26 300
Fiscal budget appropriation	NASA:	2 509 900		
	Apollo:	76 700		

APPENDIX 8—BLOCK II VS. BLOCK I APOLLO SPACECRAFT; HARDWARE, CHANGES, TESTS

[From "Manned Space Flight Report: Block II Spacecraft" in House Committee on Science and Astronautics, Subcommittee on NASA Oversight, *Investigation into Apollo 204 Accident: Hearings*, 90th Cong., 1st sess, 3, no. 4, May 10, 1967, 223-35.]

Subsystems and Units Unchanged for Block II CSM

Launch escape system	Spacecraft LM adapter
Command module reaction control system	Atmosphere supply system
Service module reaction control system engine cluster	Primary equipment cooling loop
Fuel cell power plants and entry batteries	Waste management system
Cryogenic oxygen and hydrogen storage system	Crew couches
Sequential events control system	C-band radar transponder
Emergency detection system	Ordnance devices
	Parachutes and recovery aids

New Subsystems and Units in Block II CSM

Docking system	Docking tunnel and probe
	Umbilical and pressurization
	Rendezvous radar transponder
Sequence controllers	LM docking and separation events
S-band antennas	Flush omnidirectional
	High gain

Subsystems and Units Changed in Block II CSM

Structure:	
Command module	Docking provisions, mechanism, and hatch
	Extravehicular capability
	CM/SM mechanical connection
	Scientific airlock available
Service module	Propellant tanks
	Empty bay
	Internal rearrangement
	Structural redesign
	Radiator areas
	RCS mounting panels

Propulsion:	
Service module propulsion system	Mixture ratio Thrust chamber Gimbal actuator
Service module reaction control	Propellant capacity Monomethylhydrazine fuel
Crew support:	
Environmental control system	Redundant cooling loop Radiator design and area
Spacesuit	Apollo suit Extravehicular capability
Displays and controls	Panel structure Electroluminescent lighting Entry monitor system
Power and communication:	
Electrical power system	Radiator area Distribution bus added Cable harnessing Pyrotechnic initiator Wire deadfacing at separation
Unified S-band	Primary mode for all communications Repackaged Simultaneous data and tape dump or TV
Voice VHF	Electrical redundancy Redundant and duplex
Guidance and control:	
Guidance and navigation	Digital autopilot Computer repackaged Electronics repackaged Navigation base support
Stabilization and control system	Revised interface Electronics repackaged Redundant attitude display
Atmospheric entry and touchdown:	
Heatshield	Redistributed ablative thickness Truncated apex Umbilical location Flush antennas

APPENDIX 8

Earth-landing system

Steel parachute risers
Parachute attach points
Repackaged

Crew Safety Systems

- | | |
|-------------------------------------|------------------------------|
| 1. Launch escape system | 6. Reaction control system |
| 2. Emergency detection system | 7. Electrical power system |
| 3. Sequential events control system | 8. Command module heatshield |
| 4. Earth-landing system | 9. Structure system |
| 5. Environmental control system | |

Mission Success Systems

- | | |
|-------------------------------------|------------------------------|
| 1. Spacecraft adapter | 5. Communications system |
| 2. Waste management system | 6. Displays and controls |
| 3. Guidance and control system | 7. Service propulsion system |
| 4. Stabilization and control system | |

Subsystems with Internal Redundancy

Subsystem

Major Function

- | | |
|-------------------------------------|---|
| 1. CM reaction control system | Attitude control
Lift vector control |
| 2. SM reaction control | Attitude control
S-IVB/CSM separation
CM/SM separation |
| 3. Communications system | Navigation data
Voice, telemetry, and tracking
Recovery |
| 4. Electrical power system | Electrical power |
| 5. Environmental control system | Equipment cooling
Cabin environmental control |
| 6. Sequential events control system | Separation signals
Earth-landing functions |
| 7. Emergency detection system | Launch vehicle malfunction |
| 8. Earth-landing system | Atmospheric descent
Uprighting at impact |

Backup System Capabilities for Earth-Orbital Flight

Subsystem

Major Function

Backup

- | | | |
|--|------------------|---|
| Service propulsion system | Deorbit | SM-RCS; CM-RCS |
| Command module reaction control system | Attitude control | SM-RCS spinup before separation for ballistic reentry |

Backup System Capabilities for Earth-Orbital Flight—Continued

<i>Subsystem</i>	<i>Major Function</i>	<i>Backup</i>
Guidance and control system	Attitude, translation, and lift vector control Control of SPS burns	Stabilization and control system
Stabilization and control system	Backup attitude, translation, and SPS control	Manual

Flight Safety Systems Changed in Block II

- | | |
|---|------------------------------|
| 1. Earth-landing system | 5. Command module heatshield |
| 2. Service module reaction control system | 6. Structural system |
| 3. Electrical power system | 7. Service propulsion system |
| 4. Environmental control system | |

Environmental Control System Changes for Block II before AS-204 Accident

1. New radiator design:
 - Increased size.
 - Selective stagnation control.
 - Secondary loop tubes.
2. Secondary coolant loop:
 - Additional pump.
 - Redundant cold plate passages.
3. Repackage environmental control unit (ECU):
 - Coolant pumps relocated external to ECU, repackaged, and capacity increased.
 - Coolant reservoir located external to ECU.
 - Redesigned suit heat exchanger.
4. LM pressurization capability.
5. Relocate postlanding ventilation valves.
6. Redesign steam duct.
7. Add rendezvous radar cold plates in SM.

Proposed ECS Changes for Block II after AS-204 Accident

1. Add armor plating to exposed solder joints.
2. Change soldered-aluminum oxygen lines to stainless steel.
3. Rapid cabin repressurization.
4. Improve accessibility of selected ECS controls.
5. Shields for plumbing lines.
6. Optional use of air in cabin during launch.
7. Emergency breathing masks.
8. Add quick disconnects to environmental control unit.
9. Replace selected materials.

APPENDIX 8

Block I—Major Ground Test Programs

<i>Test Article</i>	<i>Test</i>	<i>Purpose</i>
CM BP-6A	Parachute drop-testing of boilerplate CM	Flight-qualify earth recovery system by series of aircraft drop tests
SM-001	SPS propulsion ground test	Demonstrate SPS performance (oxidizer-to-fuel ratio = 2), 2d SPS-structure compatibility
SLA	Static structural test of spacecraft-LM adapter	Test SLA static structural load capability (ultimate)
CSM 004	Static and thermal structural ground test	CM static structural load test (ultimate) CSM static structural load test (ultimate) CM thermal structural load test (reentry design)
CSM 007	Varied spacecraft testing	CM and SM acoustic vibration environment test CM water-landing impact drop test Postlanding systems operational/crew compatibility tests (uprighting, postlanding ECS, post-landing communications)
CSM 008	Thermal vacuum test of complete systems spacecraft	Demonstration of structural, integrated subsystems and crew compatibility under thermal vacuum environment

White Sands Missile Range Flight Tests

<i>Test Article</i>	<i>Test</i>	<i>Purpose</i>
BP-6	Boilerplate—LES pad abort flight test	Demonstrate launch escape system's pad abort performance
BP-12	Boilerplate—LES transonic abort flight test	Demonstrate launch escape system's transonic abort performance
BP-23	Boilerplate—LES high-dynamic-pressure abort flight test	Demonstrate launch escape system's maximum-dynamic-pressure-region abort performance

White Sands Missile Range Flight Tests—Continued

<i>Test Article</i>	<i>Test</i>	<i>Purpose</i>
BP-23A	Boilerplate—LES pad abort flight test	Demonstrate launch escape system's pad abort performance with Canard, BPC, and major sequencing changes
CSM 002	Spacecraft structure—SM boost environment and LES tumbling abort flight	Determine actual spacecraft SM's dynamic structural response to boost dynamic loads Demonstrate launch escape system's tumbling abort performance and plume-impingement-load capability of CSM

Block II—Major Ground-Test Programs

<i>Test Article</i>	<i>Test</i>	<i>Purpose</i>
BP-6B	Parachute drop-testing of boilerplate CM	Flight-qualify earth recovery system by series of aircraft drop tests
F-2A	Fixture for SPS testing	Evaluate performance effects on SPS engine of fuel and oxidizer mixture's ratio change from 2.0 to 1.6
180° SM segment	Acoustic test article (SM) testing	Qualify SM structure and systems to launch and boost vibration environment
CM 28-1	Static and dynamic structural testing	Evaluate water impact on CM structure Docket CM/LM interface static structural tests
CMS 2S-2	Static structural testing	Static-test CM and SM structures (ultimate)
CMS 2TV-1	Complete systems spacecraft thermal vacuum testing	Demonstrate structural, integrated subsystems, crew compatibility, and life support in thermal vacuum environment

APPENDIX 8

*Block II—Revisions of and Additions to Major
Ground-Test Programs*

<i>Test Article</i>	<i>Test</i>	<i>Purpose</i>
2TV-1	Complete spacecraft thermal vacuum	Qualify fire related changes
004A, 007A	Unified hatch qualification	Functionally qualify acoustic testing, postlanding testing
CSM	Acoustic vibration	Demonstrate functional and structural integrity of stacked CSM-SLA
Material	Materials evaluation	Continue evaluation of non- or low-flammable material
Boilerplate	Command module fire test	Evaluate fire propagation in flight-configuration CM interior
EMU articles	Extravehicular mobility unit qualification	Qualify Block II unit with materials change
ECU articles	Environmental control unit qualification	Qualify Block II unit with all required modifications

APPENDIX 9—APOLLO EXPERIMENTS

PART I: LUNAR SURFACE EXPERIMENTS

The lunar surface experiments were of two kinds: (1) The Apollo Lunar Surface Experiments Package (ALSEP) systems, which were left on the lunar surface by the astronauts and which continued sending telemetry data until turned off Sept. 30, 1977, and (2) experiments conducted on the lunar surface by the astronauts and returned to earth in the command module. The dates and lunar coordinates are given in the following listing. The ALSEP-related experiments are listed next, by experiment number, with Apollo mission numbers.

Apollo 12: The *Apollo 12* ALSEP was deployed on November 19, 1969, at latitude 3°11' S, longitude 23°23' W in Oceanus Procellarum.

Apollo 13: Because of service module problems, a lunar landing was not accomplished during the *Apollo 13* mission.

Apollo 14: The ALSEP was deployed on February 5, 1971, at latitude 3°40' S, longitude 17°27' W in the Fra Mauro formation.

Apollo 15: The ALSEP was deployed July 31, 1971, at latitude 26°06' N, longitude 3°39' E in the Hadley-Apennine region.

Apollo 16: The ALSEP was deployed April 21, 1972, at latitude 8°59'34" S, longitude 15°30'47" E in the Descartes Highlands.

Apollo 17: The ALSEP was deployed on December 12, 1972, at latitude 20°09'55" N, longitude 30°45'57" E in the Taurus-Littrow region.

Apollo ALSEP Experiments

<i>Number</i>	<i>Experiment</i>	<i>Apollo Mission</i>				
		<i>12</i>	<i>14</i>	<i>15</i>	<i>16</i>	<i>17</i>
S 031	Passive Seismic	X	X	X	X	
S 033	Active Seismic		X		X	
S 034	Lunar Surface Magnetometer	X		X	X	
S 035	Solar-Wind Spectrometer	X		X		
S 036	Suprathermal Ion Detector	X	X	X		
S 037	Heat Flow			X	(1)	X
S 038	Charged Particle		X			
S 058	Cold Cathode Gage	X	X	X		
S 059	Lunar Geology	X	X	X	X	X
S 078	Laser Ranging Retroreflector	X	X	X		

APPENDIX 9

Apollo ALSEP Experiments—Continued

<i>Number</i>	<i>Experiment</i>	<i>Apollo Mission</i>				
		<i>12</i>	<i>14</i>	<i>15</i>	<i>16</i>	<i>17</i>
S 152	Cosmic Ray Detector				X	
S 198	Portable Magnetometer		X		X	
S 199	Traverse Gravimeter					X
S 200	Soil Mechanics	X	X	X	X	X
S 201	Far UV Camera/Spectrograph				X	
S 202	Lunar Ejecta and Meteorites					X
S 203	Lunar Seismic Profiling					X
S 204	Surface Electrical Properties					X
S 205	Lunar Atmospheric Composition					X
S 207	Lunar Surface Gravimeter					X
S 229	Neutron Probe	X	X	X	X	X
M 515	Dust Detector	X	X	X		

(1) Cable broken during deployment.

PART II: LUNAR ORBITAL EXPERIMENTS

Most of the lunar orbital experiments were added to the Apollo program during missions 15, 16, and 17. The objectives of these experiments were to determine and understand regional variations in the chemical composition of the lunar surface, to study the gravitational field of the moon, to determine the induced and permanent magnetic fields of the moon, and to make a detailed study of the morphology and albedo of the lunar surface. These experiments and the missions during which they were performed are listed in the following table.

Apollo Orbital Experiments

<i>Number</i>	<i>Experiment</i>	<i>Apollo Mission</i>				
		<i>12</i>	<i>14</i>	<i>15</i>	<i>16</i>	<i>17</i>
S 160	Gamma-Ray Spectrometer			X	X	
S 161	X-Ray Fluorescence			X	X	
S 162	Alpha-Particle Spectrometer			X	X	
S 164	S-Band Transponder (subsatellite)			X	X	

Apollo Orbital Experiments—Continued

<i>Number</i>	<i>Experiment</i>	<i>Apollo Mission</i>				
		<i>12</i>	<i>14</i>	<i>15</i>	<i>16</i>	<i>17</i>
S 164	S-Band Transponder (CSM/LM)	X	X	X	X	X
S 165	Mass Spectrometer			X	X	
S 169	Far UV Spectrometer					X
S 170	Bistatic Radar		X	X	X	
S 171	Infrared Scanning Radiometer					X
S 173	Particle Shadow/Boundary Layer (subsattellite)			X	X	
S 174	Magnetometer (subsattellite)			X	X	
S 175	Laser Altimeter			X	X	X
S 209	Lunar Sounder					X

PART III: APOLLO EXPERIMENT PRINCIPAL INVESTIGATORS

The principal investigators for the lunar surface and lunar orbital experiments are listed by experiment numbers. The lunar surface group is listed first.

Lunar Surface Experiment Investigators

<i>Number</i>	<i>Experiment</i>	<i>Principal Investigator</i>
S 031	Passive Seismic	G. V. Latham Marine Biomedical Institute, Galveston, Texas
S 033	Active Seismic	Robert L. Kovach
S 203	Lunar Seismic Profiling	Stanford University
S 034	Lunar Surface Magnetometer	Palmer Dyal Ames Research Center Charles P. Sonett Lunar and Planetary Laboratory, University of Arizona
S 035	Solar-Wind Spectrometer	Conway W. Snyder Jet Propulsion Laboratory
S 036	Suprathermal Ion Detector	John W. Freeman Rice University

APPENDIX 9

<i>Number</i>	<i>Experiment</i>	<i>Principal Investigator</i>
S 037	Heat Flow	Marcus E. Langseth Columbia University
S 038	Charged-Particle Lunar Environment Experiment	D. L. Reasoner Rice University
S 058	Cold Cathode Gage	Francis S. Johnson University of Texas at Dallas
S 059	Lunar Geology	Gordon A. Swann Center of Astrogeology, U.S. Geological Survey William R. Muehlberger University of Texas
S 078	Laser Ranging Retroreflector	James E. Faller Wesleyan University
S 152	Cosmic Ray Detector	R. L. Fleischer General Electric Research and Development Laboratory, Schenectady, N.Y. Buford Price University of California at Berkeley Robert M. Walker Washington University St. Louis, Mo.
S 198	Lunar Portable Magnetometer	Palmer Dyal Ames Research Center
S 199	Traverse Gravimeter	Manik Talwani Columbia University
S 200	Soil Mechanics	J. Mitchell University of California at Berkeley
S 201	Far UV Camera/Spectrograph	G. R. Carruthers E. O. Hurlburt Center for Space Research, Naval Research Laboratory, Washington, D.C. Thornton Page Johnson Space Center
S 202	Lunar Ejecta and Meteorites	Otto E. Berg Goddard Space Flight Center

THE APOLLO SPACECRAFT: A CHRONOLOGY

<i>Number</i>	<i>Experiment</i>	<i>Principal Investigator</i>
S 204	Surface Electrical Properties	M. Gene Simmons Massachusetts Institute of Technology David W. Strangway University of Toronto
S 205	Lunar Atmospheric Composition	J. R. Hoffman University of Texas at Dallas
S 207	Lunar Surface Gravimeter	Joseph Weber University of Maryland
S 229	Lunar Neutron Probe	D. S. Burnett California Institute of Technology
M 515	Dust Thermal Radiation Engineering Measurement	James R. Bates Johnson Space Center

Lunar Orbital Experiment Investigators

S 160	Gamma-Ray Spectrometer	James R. Arnold University of California at San Diego
S 161	X-Ray Fluorescence	Isidore Adler University of Maryland
S 162	Alpha-Particle Spectrometer	Paul Gorenstein Smithsonian Astrophysical Observatory, Cambridge, Mass.
S 164	S-Band Transponder	William L. Sjogren Jet Propulsion Laboratory
S 165	Lunar Orbital Mass Spectrometer	J. H. Hoffman University of Texas at Dallas
S 169	Ultraviolet Spectrometer	William E. Fastie Johns Hopkins University
S 170	Bistatic Radar	H. Taylor Howard Stanford University
S 171	Infrared Scanning Radiometer	Frank J. Low University of Arizona W. W. Mendell Johnson Space Center
S 173	Subsatellite Particles and Shadows	Kinsey A. Anderson University of California at Berkeley

APPENDIX 9

<i>Number</i>	<i>Experiment</i>	<i>Principal Investigator</i>
S 174	Particles and Fields Subsatellite Magnetometer	P. J. Coleman University of California at Los Angeles
S 175	Laser Altimeter	William M. Kaula University of California at Los Angeles William L. Sjogren Jet Propulsion Laboratory
S 209	Lunar Sounder	Roger J. Phillips Jet Propulsion Laboratory Stanley Ward University of Utah Walter E. Brown, Jr. Jet Propulsion Laboratory

APPENDIX 10—ORGANIZATION CHARTS

NATIONAL AERONAUTICS AND SPACE ADMINISTRATION

[1967]

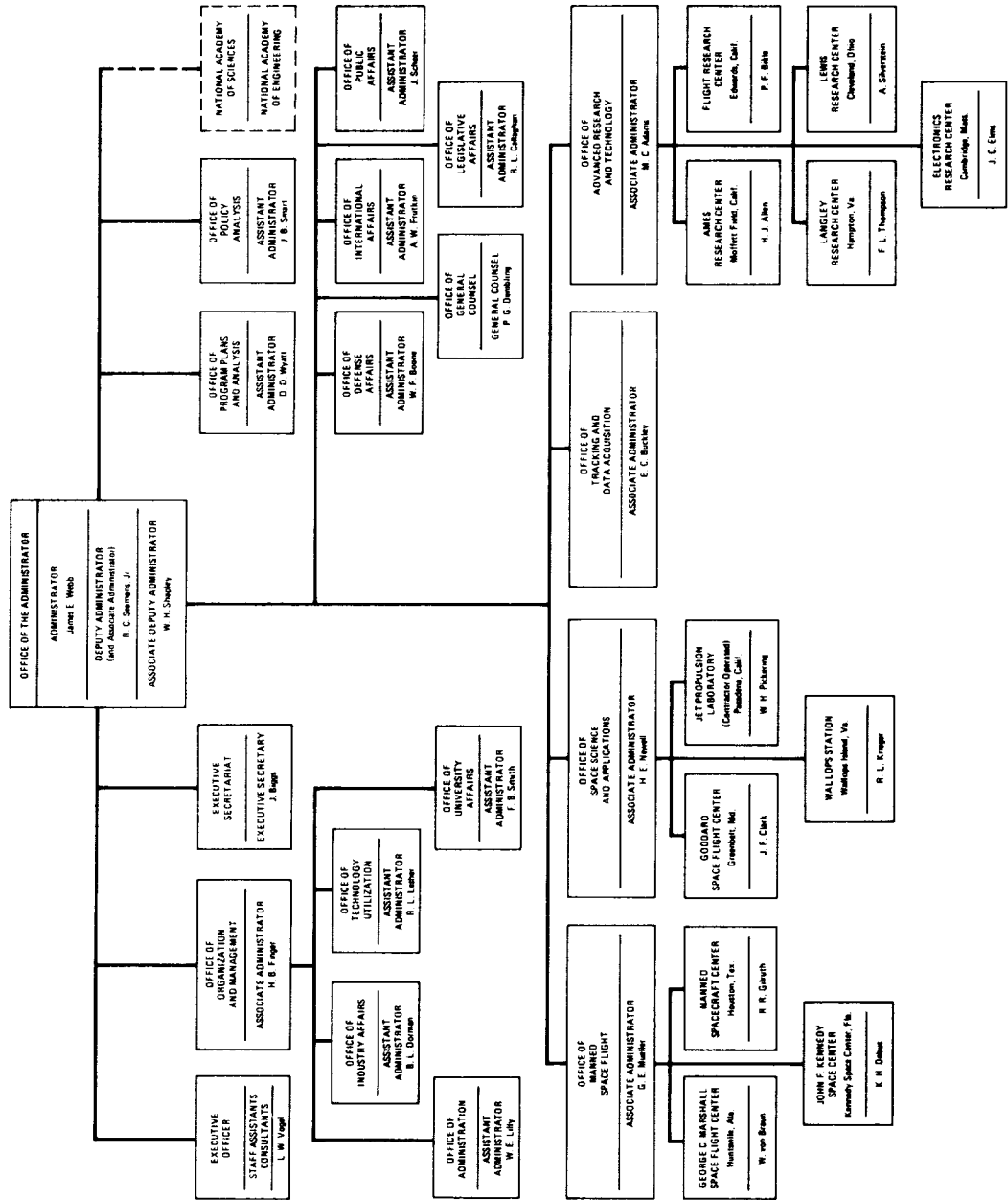

NATIONAL AERONAUTICS AND SPACE ADMINISTRATION

[February 5, 1973]

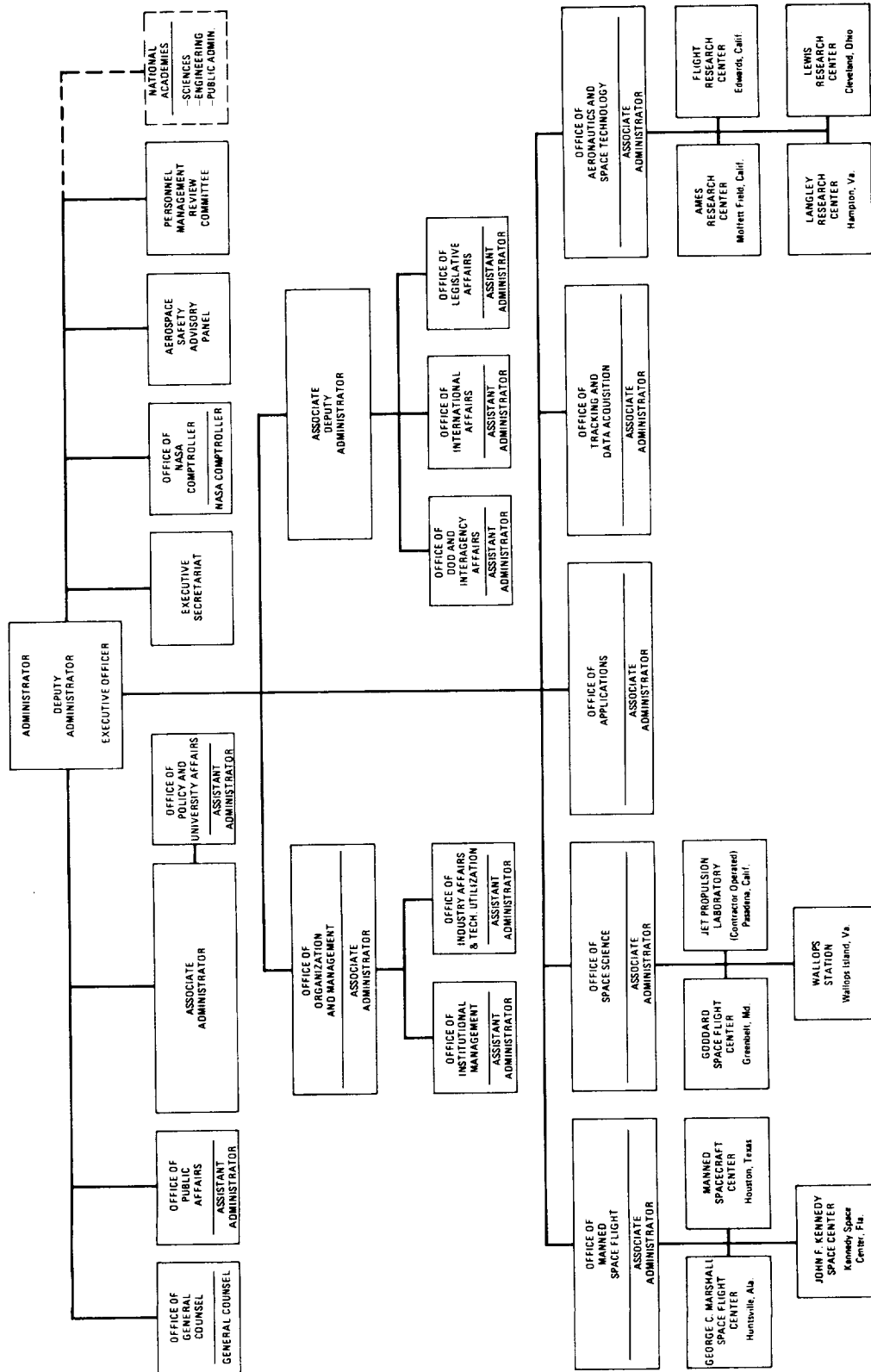

NASA OFFICE OF MANNED SPACE FLIGHT

[June 17, 1969]

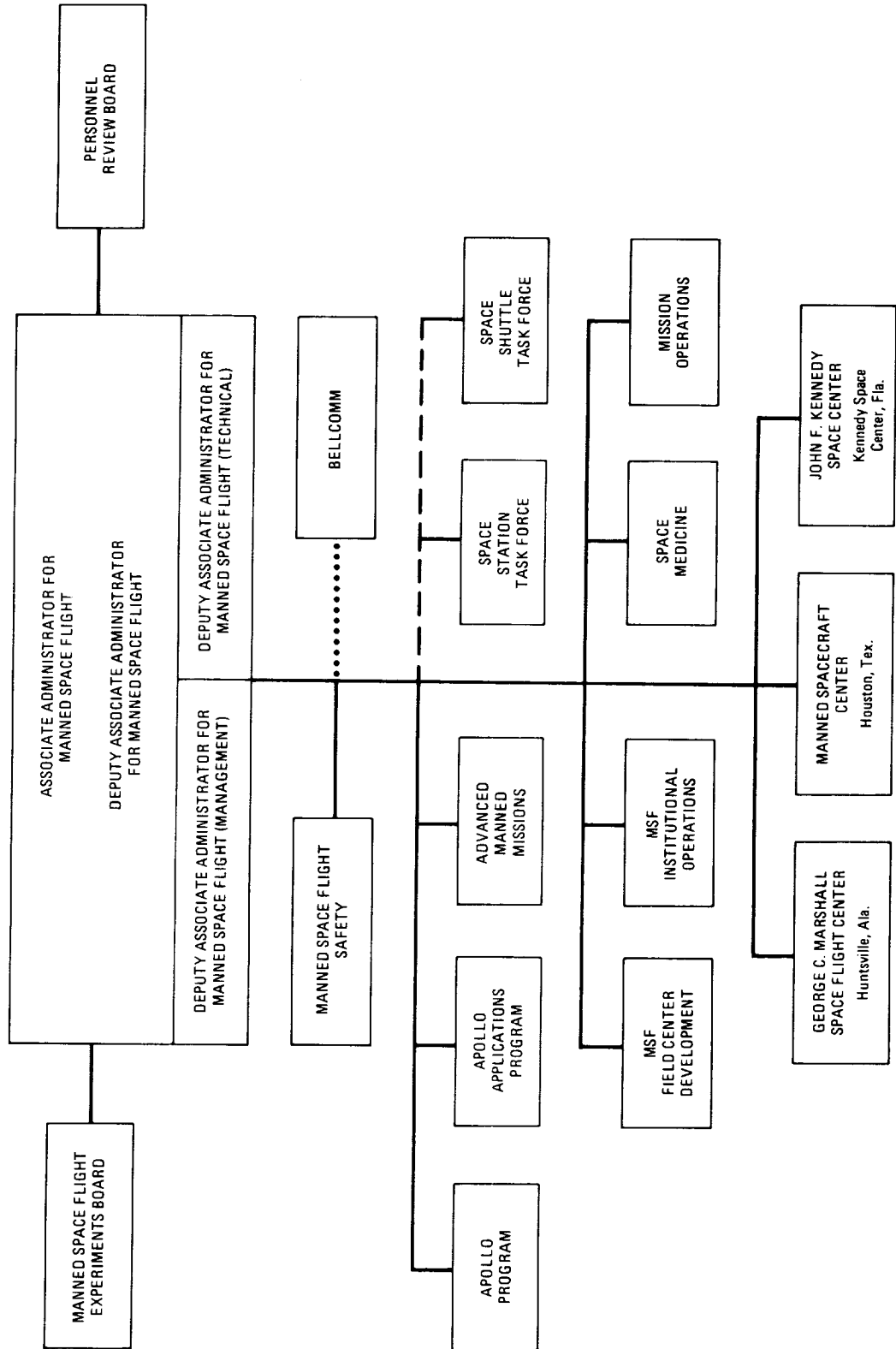

NASA OFFICE OF MANNED SPACE FLIGHT

[December 23, 1970]

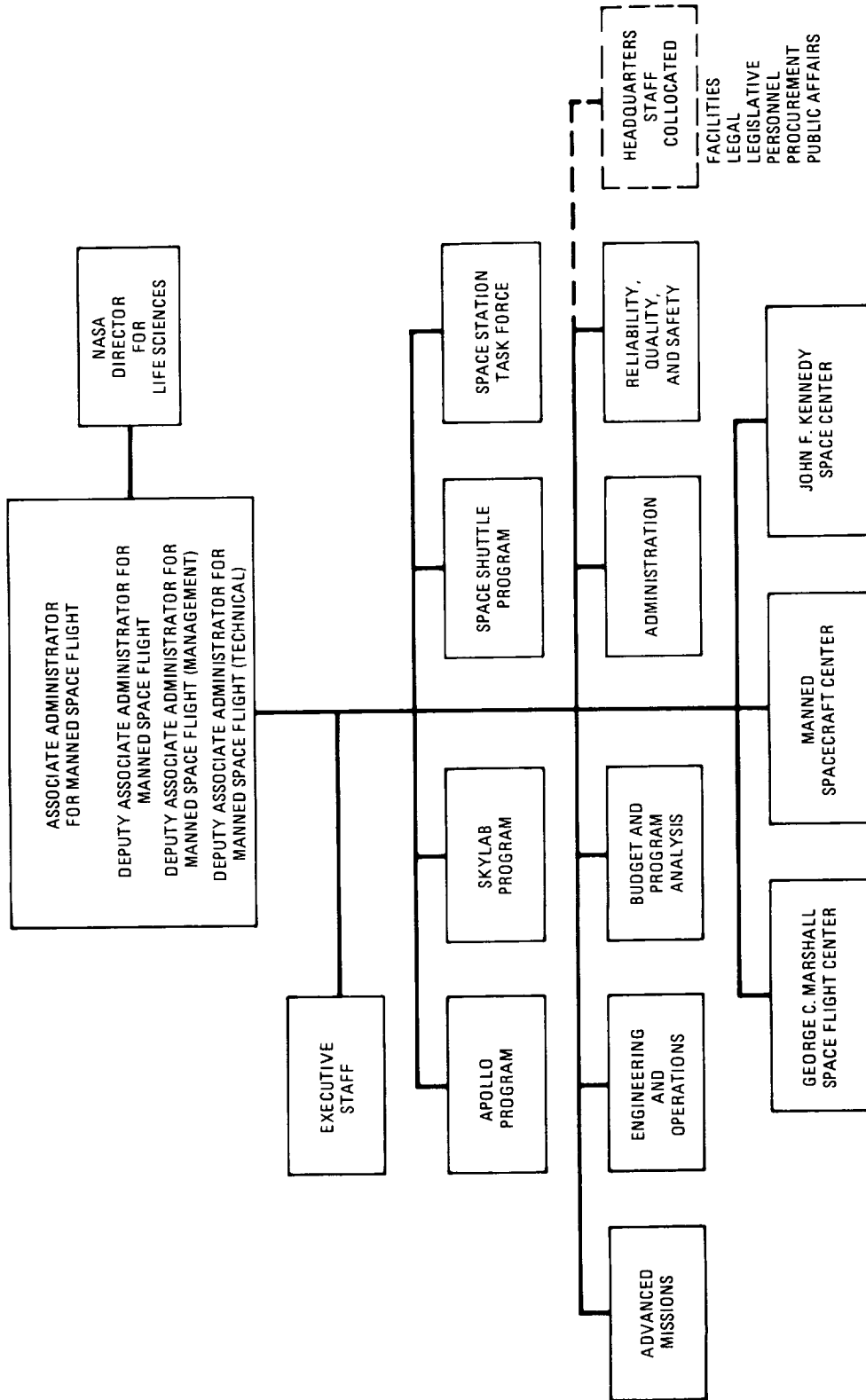

MANNED SPACECRAFT CENTER

[May 4, 1966]

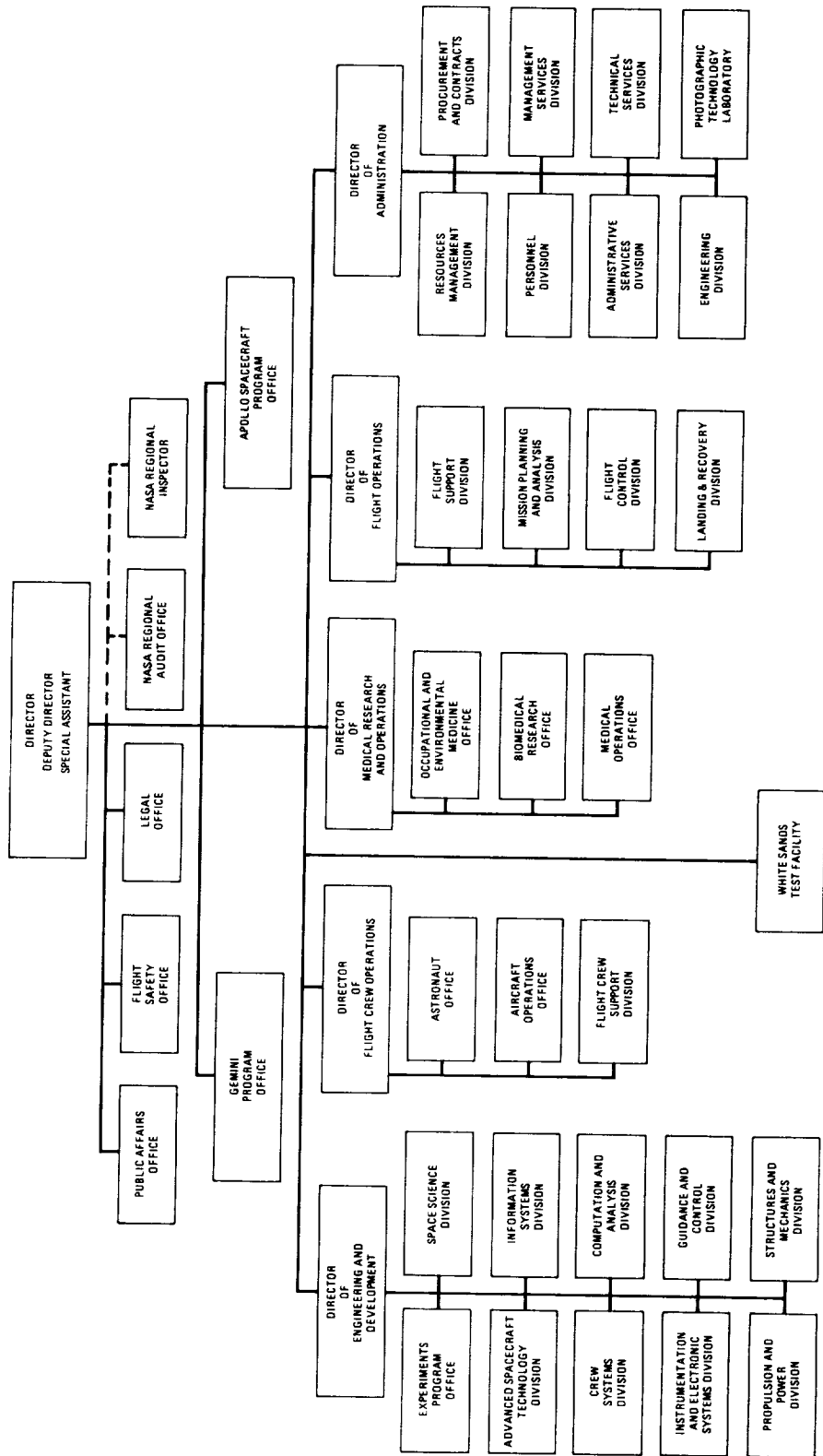

MANNED SPACECRAFT CENTER

[August 1969]

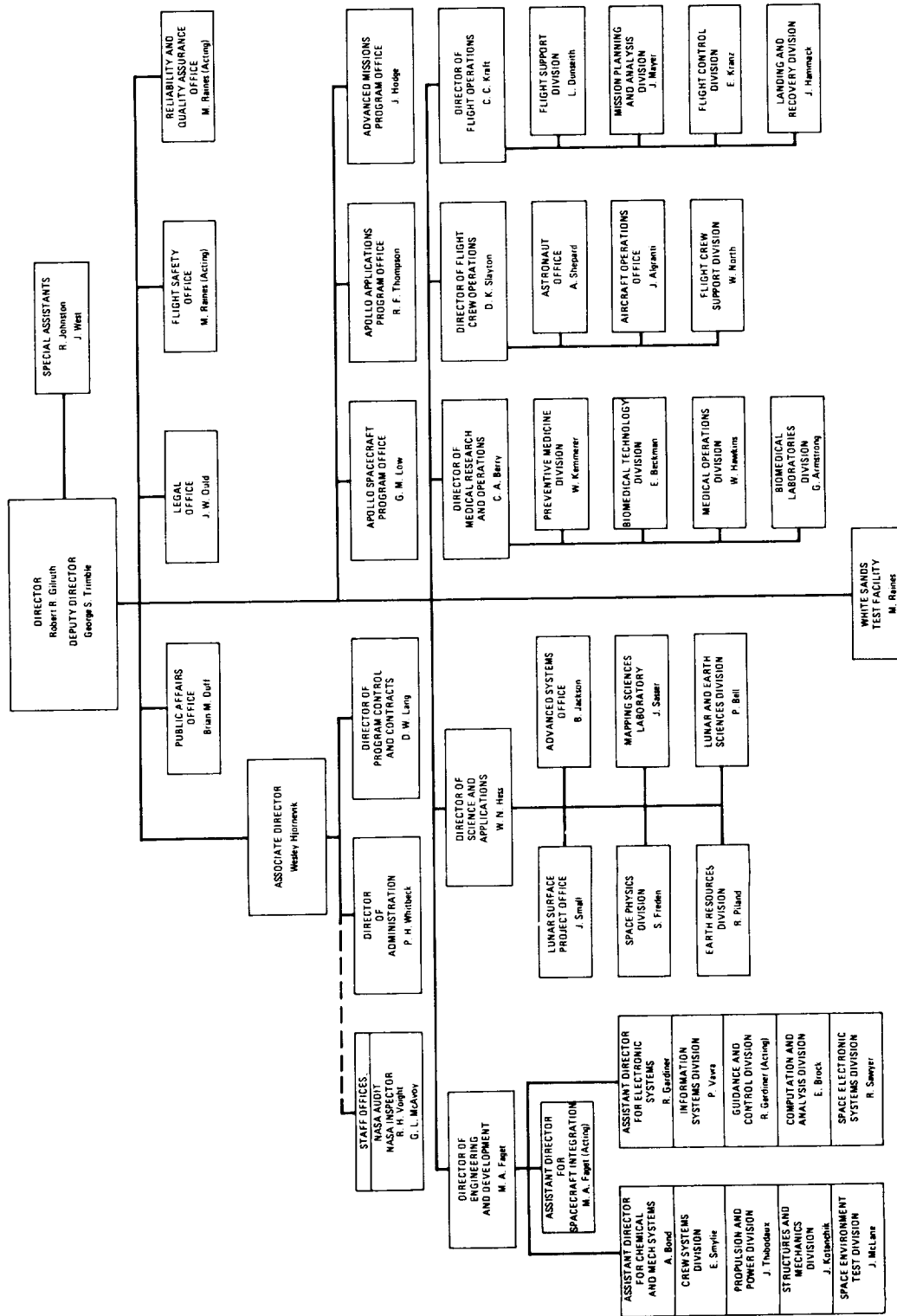

MANNED SPACECRAFT CENTER

[October 30, 1972]

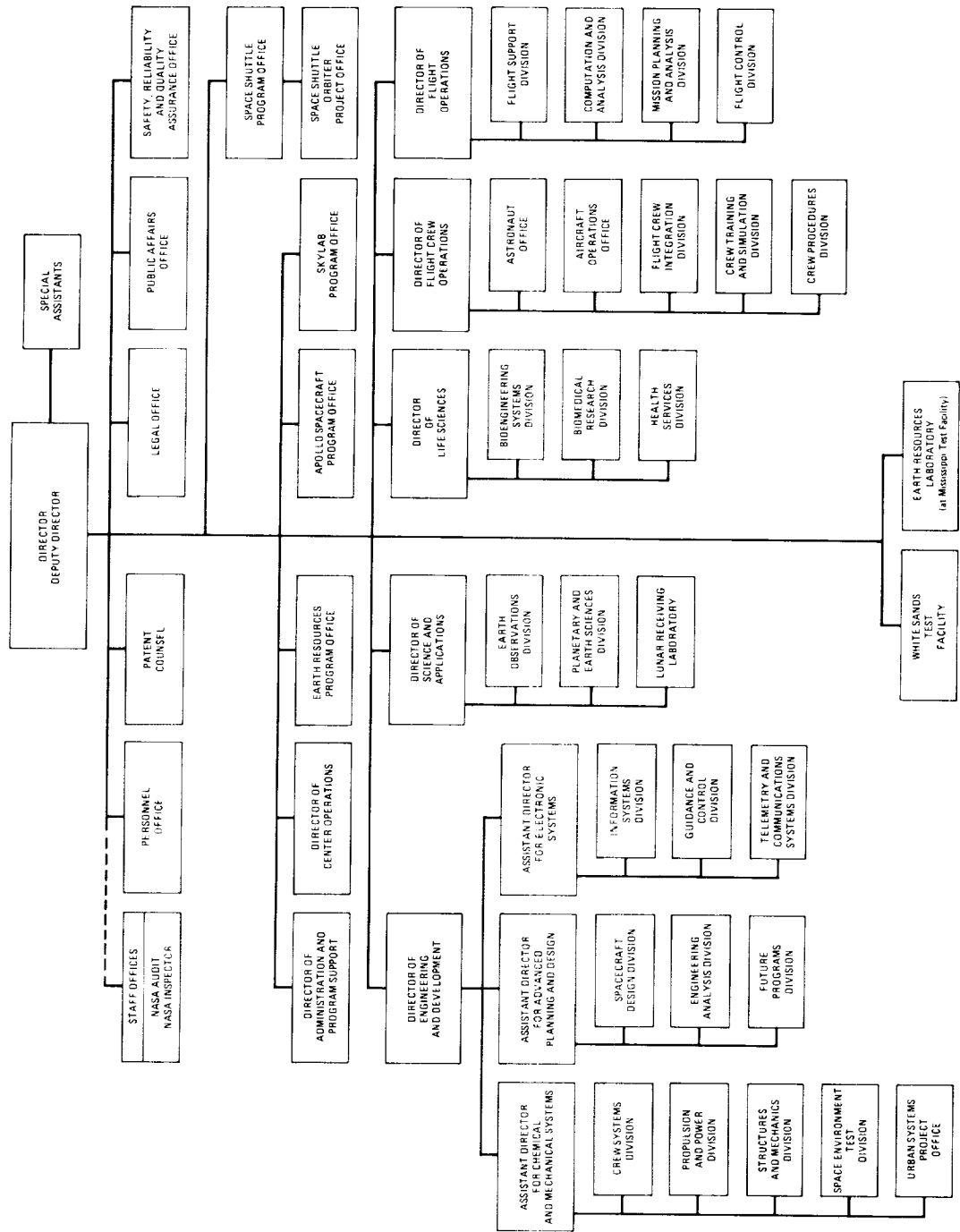

APOLLO SPACECRAFT PROGRAM OFFICE

[1966]

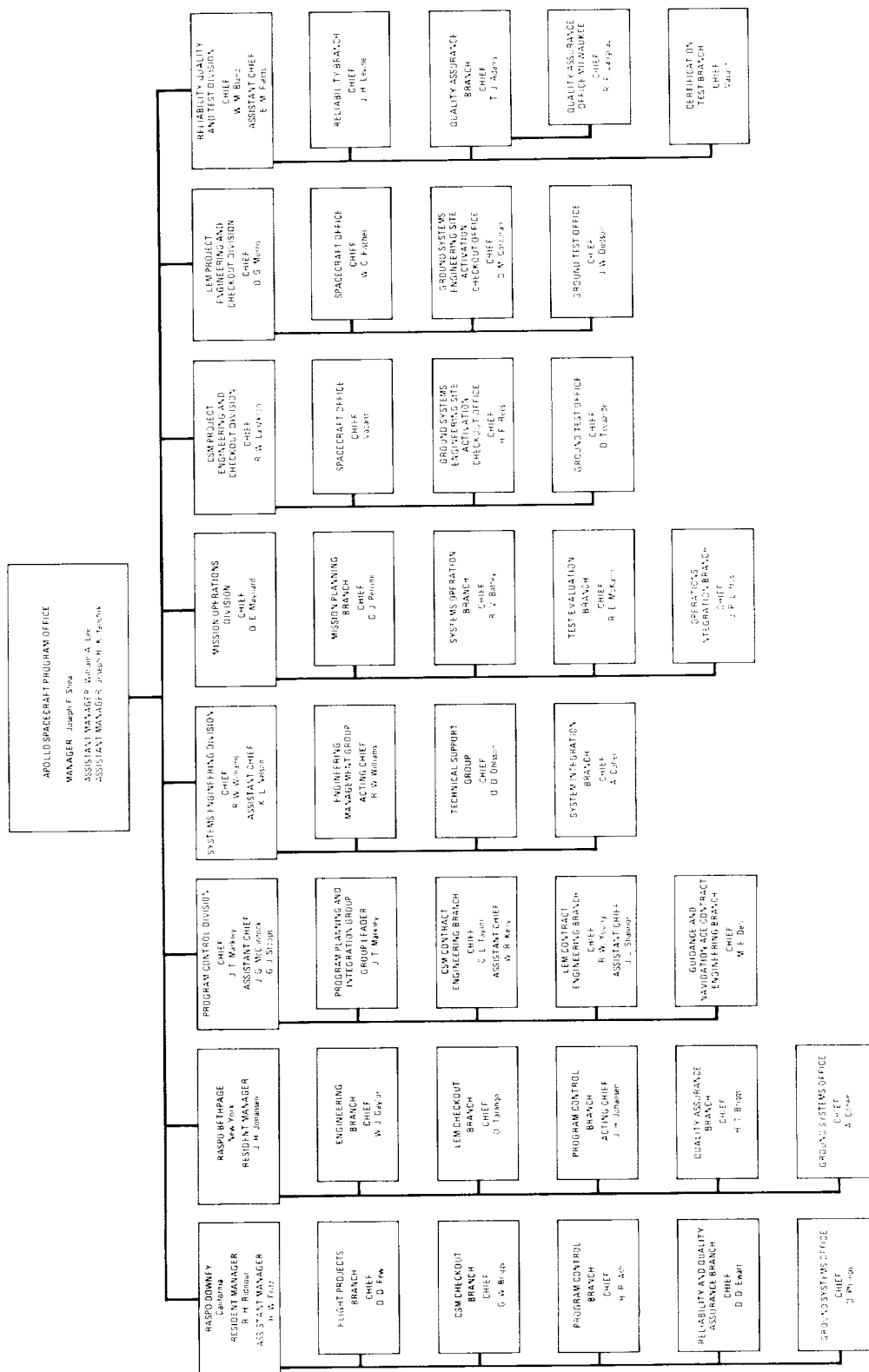

APOLLO SPACECRAFT PROGRAM OFFICE

[September 23, 1967]

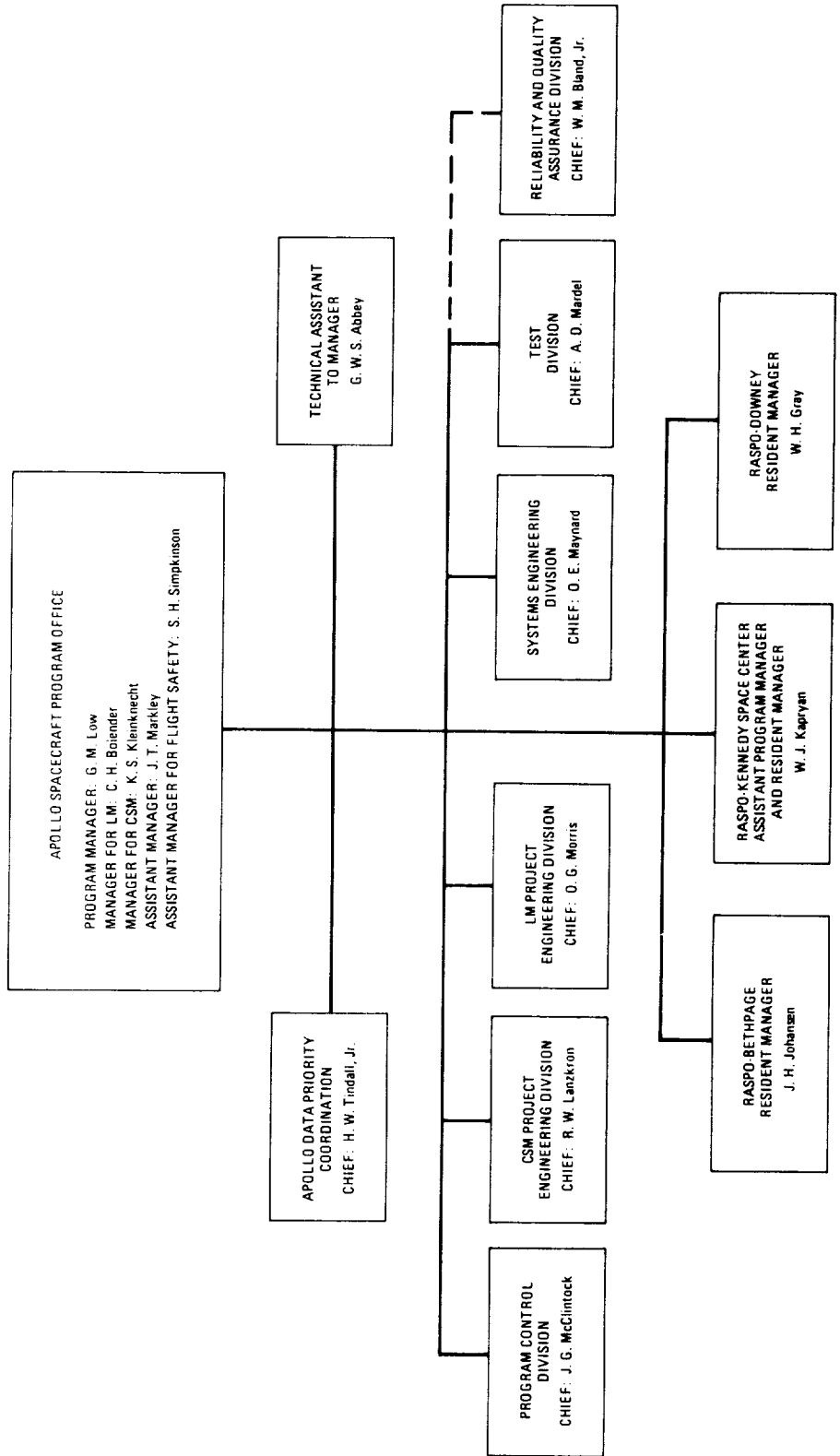

APOLLO SPACECRAFT PROGRAM OFFICE

[1971]

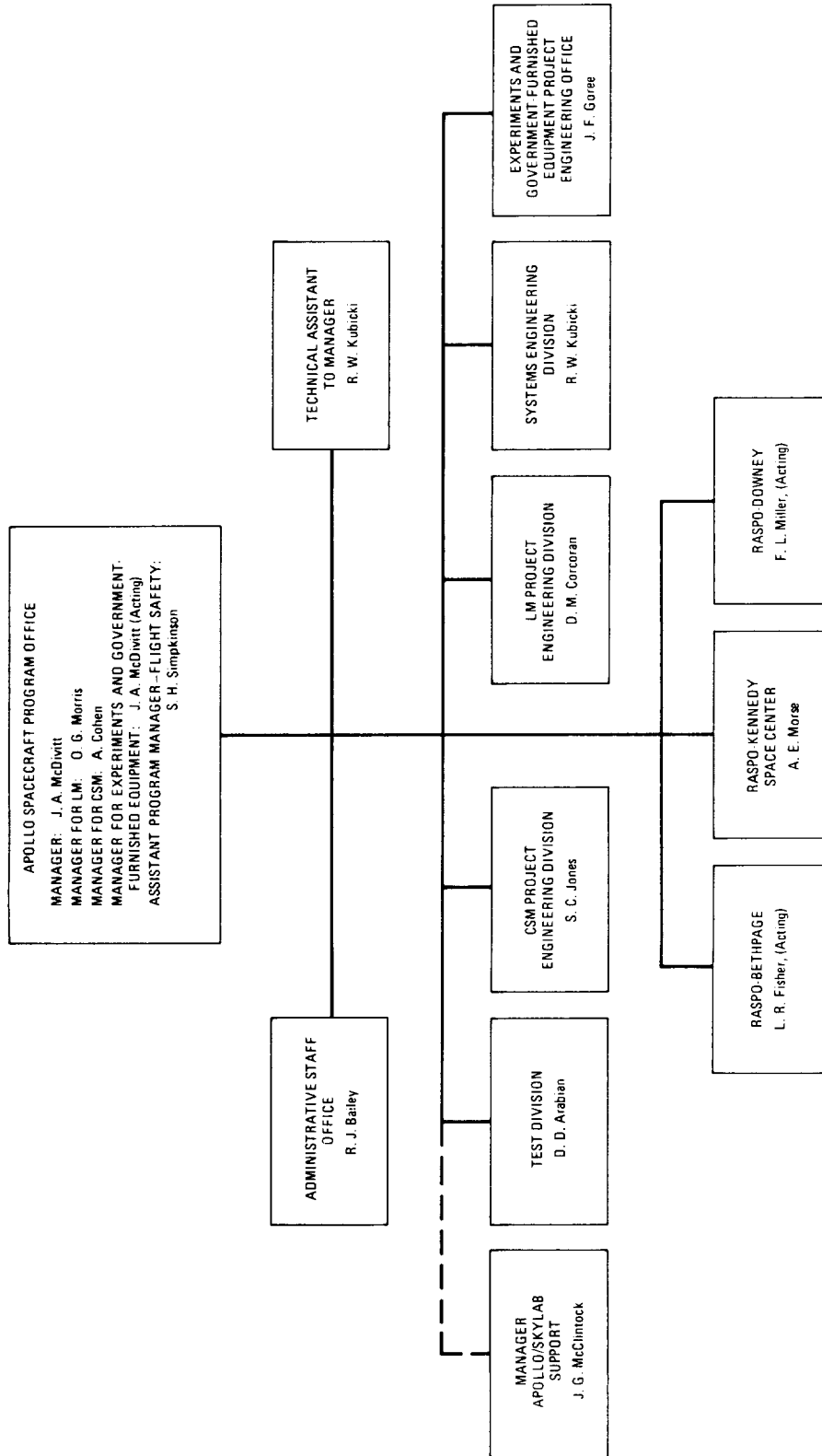

INDEX

A

- AAP missions (see also Apollo Applications program)
AAP-1, 100
AAP-2, 100
- Abbey, George W. S., 101, 219, 238
- Abort, mission
Apollo 13, 264, 330 il.-37, 338-40
crew training, 203, 269
high-altitude, 246
launch, 62, 170, 203, 254
LM landing, 270
near-pad, 163, 180-81, 269
pad, 62, 147, 170, 198, 269
studies, 14-15, 21, 22, 62, 208, 269
time-critical, 14-15
- AC Electronics Div. See General Motors Corp.
- Adair, Rear Adm. J., 44
- Adams, Mac C., 158
- Adams, T. Jefferson, 73, 87
- Aerojet-General Corp., 212-13, 328, 372
- Aeronca, Inc., 260, 372
- Aeronautics and Space Act of 1958, 361
- Aeronutronic Div. See Philco Corp.
- Aerospace Corp., 21, 185
- Aerospace Safety Advisory Panel, 332-35
- Aerospace Safety Research and Data Institute, 337
- Agriculture, Department of, 151, 165
- Aircraft, 277
B-52, 192, 213
C-133A, 169
helicopter, 277, 287, 309, 322, 332
Pregnant Guppy, 42
Super Guppy, 35
- AiResearch Div. See Garrett Corp.
- Air Force. See U.S. Air Force.
- Air Force Systems Command (AFSC), 21
- Airite Div., Sargent Industries, 252, 267, 372
- Aldrin, Edwin E., Jr., 264, 304-08 il.-10, 375, 381, 389, 408
- Algranti, Joseph S., 224, 264, 272
- Allen, Maj. Gen. Brooke F., 220
- Allen, H. Julian, 34
- Allen, Joseph P., 409
- Aller, Robert O., 140
- Alley, C. O., 130
- Allison Div., General Motors Corp., 252, 267, 372
- America*. See *Apollo 17* and CSM 114.
- American Bosch Arma Corp., Arma Div., 37-38
- American Broadcasting Co., 363
- Ames Research Center, 9, 33-34, 161, 269, 361-62
- Anders, William A., 56, 224, 243, 275, 374, 386, 408
- Anderson, Sen. Clinton P., 340
- Anderson, Frank W., Jr., xiv
- Anderson, Robert, 338
- Ann Arbor, Mich., 138
- Antares*. See *Apollo 14* and LM-8.
- Apollo 1. See AS-204 and Apollo 204 Review Board.
- Apollo 1-A (rejected number). See AS-201.
- Apollo 2 (rejected number). See AS-202.
- Apollo 3 (rejected number). See AS-203.
- Apollo 4* (see also AS-501), 156, 191, 217, 222
ad hoc Safety Group, 146
checkout and readiness, 143
CSM. See CSM 017.
designation, 100, 130
launch, 116, 172-73 il., 384
LTA-10R, 172
objectives, 172, 402-03
recovery, 172, 173 il.
results, iii, 179, 384
- Apollo 5* (AS-204/LM-1), 153 il., 162, 191
alternate mission plans, 196
checkout and readiness, 143
designation, 97, 100, 130
flight readiness review, 181
launch, 116, 196, 384
launch date, 193
LM. See LM-1.
objectives, 170-71, 196, 403
results, 384
schedule difficulties, 153-54
- Apollo 6* (see also AS-502), 179, 222
Abort and Alternate Mission Study, 208
adapter failure, 269
CSM. See CSM 020.
debris hazard, 208
designation, 130
flight readiness review, 181, 207, 210
J-2 engine failure, 215-16, 222, 232
launch, 117, 215-16 il.-17, 384-85
launch date, 52, 68-69, 171, 210, 215, 222
LTA-2R, 207, 215-17
objectives, 52, 171, 183, 217, 404
results, 217, 384-85
pogo problems, 215, 222, 233-34, 237, 242
Saturn V, 117, 191, 215-16 il.-17, 222
- Apollo 7* (see also AS-205), iv, vi, 140, 191, 222
adapter panel, 268-69
Block II CSM (see also CSM 101), 80, 117, 232-33, 258 il.-59
constraints, weather, 254
crew, 41-42, 116, 133, 257-58 il., 385, 408
Crew Safety Review Board, 253, 254
critical action items, 257
Design Certification Review, 241-42
earth-orbital mission, 238-40, 257-59
first manned flight, iv, vi, 88, 110, 117, 126-27, 139, 140, 385
flight readiness review, 233, 241-42, 251, 253, 254
fuel cells, 259
Hurricane Gladys, 259 il.
integrated system testing, 242
launch, 117, 257-59, 385
objectives, 88, 240, 259, 404
CSM/S-IVB rendezvous, 88, 123, 139, 140, 142, 258, 404
operational philosophy, 254
optical rendezvous, 259
orbital rendezvous maneuvers, 258
reaction control system, 231, 258
records, 374
recovery, 258 il., 259, 385
results, iv, vi, 240, 259, 268, 385
service propulsion system, 231, 258
flight combustion stability monitor, 231
S-IVB stage (see also objectives), 257-58
TV, live, 117, 218, 258-59, 385

INDEX

- Apollo 8* (see also AS-503), iv, vi, 191
 AS-503/CSM 103/LM-3, 162, 168, 222-23, 237
 mission D canceled, 242-43
 crew, 56, 243, 275, 386, 408
 crew recovery briefing, 272
 CSM. See CSM 103.
 distance from earth, 314
 earth orbital possibility, 238
 final countdown, 273
 final flight plan, 272
 fogging effect, 279
 helicopter, 277
 launch, 264, 275-77, 386
 escape system, 255
 pad, 255, 262, 275
 preparations, 237, 242-44, 253, 255, 262, 268-69, 272-73
 schedule, 239, 243, 246, 253, 268
 LM-3 problems (see also LM-3), 242
 LTA-B, 175, 239, 243-44, 268-69
 mission, lunar orbit, iv, 117, 168, 171, 179, 237-41, 264, 271, 275-76 il.-77, 386
 decision, 117, 241
 Mission Control Center test, 272
 MSFN test, 272
 objectives, iv, 57-58, 168, 179, 242-43, 277, 404
 records, 314, 374
 recovery, 264, 276 il., 277
 results, 277, 386
 rollout, 253, 255 il.
 S-IC stage refueling, 272
 Saturn V launch vehicle, 222, 242, 244, 247, 255 il., 264, 268-69, 301, 386
 service module, 277
 reaction control system, 268, 275
 service propulsion system, 271, 272, 276
 spacecraft hoisting loop, 283
 special task team, 268-69
 TV, 275-77, 386
- Apollo 9* (see also AS-504), iv
 Atlantic Ocean recovery, 264, 282, 287
 computer delay, 279
 countdown, 284
 test, 285 il.
 crew, 243, 278, 286-87, 289, 387, 408
 CSM *Gumdrop*. See CSM 104.
 designation, 268
 EVA, 264, 286, 287 il., 374, 388, 405
 flight readiness test, 279
 launch, 264, 286-87, 387-88
 launch preparations, 237, 262, 273, 278, 279, 281, 285 il.
 LM *Spider*. See LM-3.
 LM-CSM separation, rendezvous, and docking, iv, 264, 286, 287 il., 289, 388
 mission, manned orbital, iv, 171, 243-44, 264, 282, 284, 286-87 il., 291, 387-88
 modifications, 279
 objectives, iv, 243-44, 264, 287, 404-05
 records, 374
 results, 264, 288-89, 291, 387-88
 rollout, 278
 schedule, 170-71, 282
 software integration test, 278
 thermal vacuum test, 278
 training, 278, 281
 TV, 273, 277, 286
- Apollo 10* (see also AS-505), iv
 CM tunnel insulation, 306
 crew, 291, 296-98, 388-89, 408
 crew compartment fit and function test, 292
 CSM *Charlie Brown*. See CSM 106.
 designation, 268
 experiment support facilities, 295
 flight readiness test, 289, 292
 fuel cells, 279
 launch, 264, 296-98, 388-89
 Launch Complex 39, Pad B, 289, 296
 launch preparations, 273, 279, 289
 launch readiness date, 279, 289, 294
 LM *Snoopy*. See LM-4.
 LM-CSM separation and docking, 296-97 il.-98, 388-89
 lunar orbit mission, iv, 171, 264, 282, 291, 296-97 il.-98, 388-89
 mission plan, iv, 298
 objectives, iv, 264, 298, 299-300, 405
 records, 374
 recovery, Pacific, 264, 298
 results, 298, 388
 S-IC stage, 293-94
 S-IVB stage, 296, 299-300
 SA-505, 282
 schedule, 171, 282, 291
 spacecraft docking test, 279
 translunar insertion dispersions, 299
 TV, color, 264, 296-98, 302
- Apollo 11* (AS-506), iv-v, 295, 314, 337, 364
 anniversary, 265, 337, 363 il., 364
 CM postflight security, 310
 crew, 264, 304, 305, 389, 408
 training, 272, 299-300, 301, 303-05
 CSM *Columbia*. See CSM 107.
 distance from earth, 314
 erectable antenna, 256, 294
 EVA, 59-60, 155, 168, 207, 245-46, 247, 256, 260-61, 307-08 il., 324, 375, 389, 405-06
 experiments, 142-43, 155, 245-49, 256, 261, 280, 295, 301-03, 307-08 il., 310, 312-13, 361 il.
 first men on moon, iv, v, xiv, 264, 304, 307, 389
 flags, 307-08 il., 314
 flight readiness test, 301
 launch, 264, 306-08 il.-10, 389
 launch preparations, 301-05
 LM *Eagle*. See LM-5.
 lunar dust, 325
 lunar samples, 155, 261, 265, 307, 313, 326 il., 363
 analyses, 264, 313, 326
 management debriefing, 311
 mission activities, 155, 246, 247, 261, 306-08 il.-09 il.-10, 324, 389
 mobile quarantine facility, 302, 303, 309
 Nixon, President, talk with, 307
 objectives, v, 261, 264, 282, 310, 405-06
 oscillations, 294
 quarantine, 305-06, 309, 310, 312
 records, 302-03, 314, 375
 recovery, 264, 282, 304, 307, 309
 results, 310, 389
 stereo camera, 293, 311
 Tranquility Base, 307-08 il., 313, 361 il., 389
 translunar insertion dispersions, 299
 TV, color, 264, 302, 306-07

INDEX

- Apollo 12* (AS-507), v, 171
 ALSEP, v, 295, 319, 332, 361 il., 400, 420-25
 biological isolation garment, 317, 322
 crew, 319, 391, 408
 problems, 323, 324
 program/project debriefing, 323
 scientific debriefing, 327
 CSM *Yankee Clipper*. See CSM 108.
 EVA, 264, 295, 316, 319-20 il.-21, 324, 375, 391, 406
 experiments, 295, 301, 319-20 il., 332, 361 il., 400, 420-25
 film, 315, 321, 326
 guidance and navigation control system, 318
 helicopter, 322
 launch, 264, 319-22, 391
 launch preparations, 293, 318
 lightning, 319, 328, 391
 LM *Intrepid*. See LM-6.
 lunar dust, 323, 324
 lunar samples, 264, 295, 313, 320-21, 393
 mission activities, 295, 315, 319-20 il., 322, 391
 mobile quarantine facility, 318, 321 il., 322
 objectives, v, 282, 322, 406
 Ocean of Storms (Oceanus Procellarum), 311, 319-320 il., 361 il., 391
 onboard camera, 315
 oxygen purge system, 319
 proposed lunar landing site, 300
 quarantine, 322
 records, 316, 375
 recovery, 264, 282, 322, 391
 results, 322, 332, 391
 schedule, 282, 311
 scientific payload weight, 292
 seismometer, 329, 341, 342, 348, 349, 352, 358, 360
Surveyor III, parts retrieval, 264, 300, 315, 318, 321, 391
 TV, 319-22
 Velcro use, 300
- Apollo 13* (AS-508), v, vi, vii, 363
 abort, v, 264, 330 il.-40, 392
 ALSEP, 318
 crew, 329-32, 392, 409
 CSM *Odyssey*. See CSM 109.
 Fra Mauro, tentative landing area, 311
 free return trajectory, 264, 331
 launch, 264, 329-32, 392
 launch readiness date, 293
 LM *Aquarius*. See LM-7.
 lunar sample photography list, 327
 objectives, v, 406
 oxygen tank failure, v, vi, vii, 264, 330 il.-339 il.-40, 392
 records, 375
 recovery, v, 264, 282, 331 il., 332, 392
 results, 392
 S-IVB lunar impact, 329
 schedule, 171, 282, 293, 311, 325
 soil thermometer, 318
 TV, 329, 363
- Apollo 13 Review Board
 established, 264, 332
 findings, 332-34
 recommendations, 334-35
 actions initiated, 336-40
 MSC actions, 338-40
- Apollo 14* (AS-509), v
 achievements (see also objectives), 342-43
 ALSEP, v, 342, 361 il., 400, 420-25
 anomalies, 341
 Crater Censorinus, tentative landing area, 311
 crew, 338 il., 340 il., 341-343 il., 394, 409
 CSM *Kitty Hawk*. See CSM 110.
 docking difficulty, 341
 EVA, v, 265, 341-43 il., 375-76, 394, 406
 flight readiness review, 341
 Fra Mauro landing site, 265, 341-43 il., 361 il., 394
 hold for weather, 341
 launch, v, 265, 341-43, 394
 LM *Antares*. See LM-8.
 lunar samples, 341-43, 394
 mission activities, 341-43 il., 394
 mobile equipment transporter, v, 265, 338 il., 342, 343 il. 394
 objectives, v, 342, 406-07
 oxygen storage system, 339-40
 photography of Descartes region, 342
 pre-liftoff readiness review, 341
 quarantine, 342
 records, 375
 recovery, 265, 342, 343 il., 394
 results, 342-43, 394
 S-IVB lunar impact, 341
 schedule, 311, 325, 338
 seismometer, 342, 348, 349, 352, 358, 360
 TV, 340-42
- Apollo 15* (AS-510), v
 ALSEP, 295, 344 il., 348, 361 il., 400, 420-25
 anomalies, 350
 Apollo 16 redesignated 15, 338
 color TV, 347
 crew, 344 il., 347 il.-50, 395, 409
 crew quarantine discontinued, 345
 CSM *Endeavor*. See CSM 112.
 EVA, v, 265, 345 il., 346, 347 il.-49, 376, 396, 407
 extravehicular mobility unit (EMU), 345 il.
 Hadley-Apennine landing site, 265, 347 il.-49, 361 il., 396
 launch, 265, 347-50, 395-96
 LM *Falcon*. See LM-10.
 lunar orbital science experiments, 348-49 il.
 lunar roving vehicle (Rover), 265, 346 il., 347 il.-48, 350-51, 396
 lunar samples, 348-49, 396
 Lunar Surface Science Project, 295
 mission activities, v, 344, 346-47 il.-49 il.-50, 396
 objectives, v, 350, 407
 photography, 344, 346, 348, 349 il., 396
 quarantine, 265, 345
 records, 376
 recovery, 265, 350
 results, 350-51, 395-96
 schedule, 311, 325, 338
 scientific instrument module, v, 349 il.-50, 396
 seismometer, 349, 352, 358, 360
 subsatellite, 349, 362, 396
 televised lunar liftoff, 265, 349
- Apollo 16* (AS-511), v
 ALSEP, 354, 361 il., 398, 400, 420-25
 anomalies, 352
Apollo 15 experiment validation, 354

INDEX

- Crater Tycho, tentative landing area, 311
- crew, 352-53 il.-56, 397-99, 409
- CM accident, 356
- CSM *Casper*. See CSM 113.
- Deactivation Investigation Board, 356
- Descartes landing site, 265, 346, 354, 361 il., 398
- EVA, 265, 316, 353 il.-54, 356, 376, 398-99, 407 flags, 352
- launch, 265, 352-56, 397-99
- LM *Orion*. See LM-11.
- lunar flyer, 316
- lunar orbital science experiments, 328, 354, 355 il.
- lunar roving vehicle (Rover), 265, 350, 354, 398
- lunar samples, 265, 353 il., 354, 398
- mission activities, v, 352-53 il.-56, 397-98
- objectives, v, 356, 408
- preparations, 350
- quarantine, 265, 345
- records, 376
- recovery, 265, 356, 399
- redesignated Apollo 15 (Apollo 17 redesignated 16), 338
- rendezvous, 352, 355
- results, 356, 397-99
- S-IVB lunar impact, 352, 353
- schedule, 311, 325, 338
- scientific instrument module, v, 328, 353 il., 355 il., 356, 399
- seismometer, 358, 360
- spacesuit improvement, 315, 345 il.
- special instrumentation, 346
- subsattellite, v, 355, 398-99
- tanks, 356
- visual light flash, 355
- Apollo 17 (AS-512), v**
 - ALSEP, v, 358, 361 il., 420-25
 - crew, 357, 359 il.-60, 399-400, 409
 - CSM *America*. See CSM 114.
 - EVA, v, 265, 358-59 il.-60, 399-400, 407
 - last Apollo mission, v, 338, 357, 399-400
 - launch, 265, 357-60, 399-400
 - LM *Challenger*. See LM-12.
 - lunar orbital science experiments, 328, 357, 360
 - lunar plaques, 358, 359 il., 363
 - lunar roving vehicle, v, 265, 358, 360, 399-400
 - lunar samples, 358, 360, 400
 - Marius Hills, tentative landing site, 311
 - medical responsibility, 357
 - mission activities, 357-59 il.-60, 399-400
 - objectives, v, 360, 408
 - quarantine, 265, 345
 - records, 376
 - recovery, 265, 360, 400
 - redesignated Apollo 16 (Apollo 18 redesignated 17), 338
 - results, 360, 400
 - S-IVB lunar impact, 358
 - schedule, 311, 325, 338
 - scientific instrument module, v, 328, 358, 360
 - spacesuit improvement, 315, 345 il.
 - special instrumentation, v, 346
 - Taurus-Littrow landing site, 265, 358-59 il., 361 il., 399
- Apollo 18**
 - lunar orbital science experiments, 328
 - redesignated Apollo 17, 338
 - schedule, 311, 325, 338
- Schröter's Valley, tentative landing site, 311
- scientific instrument module, 328
- spacesuit improvement, 315, 345 il.
- Apollo 19**
 - Hyginus Rille, tentative landing area, 311
 - lunar orbital science experiments, 328
 - mission deleted, 338
 - schedule, 311, 325
 - scientific instrument module, 328
 - spacesuit improvement, 315, 345 il.
- Apollo 20**
 - Crater Copernicus, tentative landing area, 311
 - CSM 115A, 327
 - LM-4, 327
 - launch vehicle, 311, 326
 - lunar orbital science experiments, 327, 328
 - mission deleted, 325-26, 327
 - schedule, 311, 325-26
 - spacesuit, 315, 327, 345 il.
- Apollo 204 Review Board, iii, 3, 63-114, 219**
 - ad hoc committee to establish task panels, 65-66
 - Advisory Group, 70-71
 - anomaly suspect items, 72, 76, 101
 - astronaut observers, 71
 - Board monitors, 73-74, 75
 - briefing for Board on anomalies, 65, 76
 - briefing for NASA officials, 65, 75, 76, 77-78
 - CM 012 material categories, 76, 81
 - congressional testimony. See U.S. Congress.
 - consultants, 65, 69, 70
 - dissolved, 136
 - established, iii, 3, 63-65
 - executive sessions, 67
 - findings, 68-69, 76, 77-79, 110-14, 124-25, 131, 133, 157
 - formal report, 3, 110-14, 124-25, 131, 133, 157
 - instructions, 64-65, 68, 69
 - interim reports, 68-69, 76, 79
 - membership (see also Advisory Group and panels), 63-66, 69
- Panel Coordinating Committee, 67, 69, 80, 89, 98 panels**
 - established, 3, 73-74
 - membership, 70, 73-74
 - No. 1, Spacecraft and Ground Support Equipment Configuration, 73, 90-91
 - No. 2, Test Environments, 73, 99-100
 - No. 3, Sequence of Events, 73, 102-03
 - No. 4, Disassembly Activities, 66, 68, 71, 73, 77, 81, 97-99
 - No. 5, Origin and Propagation of Fire, 68, 70, 72-73, 75, 76, 92-93
 - No. 6, Historical Data, 73, 104-05
 - No. 7, Test Procedures Review, 73, 103-04
 - No. 8, Materials Review, 73, 94-97
 - No. 9, Design Review, 71, 73, 105-06
 - No. 10, Analysis of Fracture Areas, 73, 89-90
 - No. 11, Medical Analysis, 71, 74, 107-09
 - No. 12, Witness Statements, 71, 74, 83-85
 - No. 13, Ground Emergency Provisions, 71, 74, 93-94
 - No. 14, Security Operations, 74, 91-92
 - No. 15, Board Administrative Procedures, 74, 89
 - No. 16, Special Tests, 74, 86
 - No. 17, Final Board Report, 74, 75

INDEX

- No. 18, Integration Analysis, 74, 86, 103, 107, 133
- No. 19, Safety of Investigation Operations, 66, 74
- No. 20, Inflight Fire Emergency Provisions Review, 71, 74, 85-86
- No. 21, Service Module Disposition, 73, 74, 86-87
- recommendations, 78, 79, 110-14, 124-25
- reviews of findings, 124-25
- SM 012 disposition, 75
- task panels. See panels.
- witness statements, 71, 83-86
- Apollo Applications program (AAP), 25, 27, 30-31, 33, 40, 47, 100, 228-29, 315
- Apollo Crew Safety Review Board, 246-47, 254, 256, 269
- Apollo Design Certification Review, 20, 42-43, 47, 149, 181-82, 202, 232-33, 236-37, 241-42
- Apollo Entry Performance Review Board, 160-61
- Apollo Executive Committee, Apollo 8 decision, 240-41
- Apollo Experiment Pallet program, 18, 37
- Apollo Failure Contingency Plan, 68
- Apollo Guidance Software Task Force. See Software Task Force.
- Apollo Lunar Surface Experiment Package (ALSEP; see also Experiments and Appendix 9), 155, 205, 261, 282, 295, 357, 361 il., 362
 - ALSEP I, v
 - ALSEP II, v, 102
 - ALSEP III, 102
 - ALSEP IV, 102
 - Apollo 12* ALSEP status, 332
 - Array A-2, 295
 - Array B, 102, 131-32
 - contract, 13, 57, 131-32, 138-39, 295, 302
 - deletion from early missions, 245-46, 247-49, 261
 - deployment, v, 29, 59-60, 207-08, 245-46, 295, 319, 342, 348, 354, 358, 361 il.
 - experiments, v, 9, 261, 301
 - active seismic, 9, 102, 301, 321, 342, 360
 - central station, 56, 58, 295, 310, 345, 361 il.
 - charged particle lunar environment, 102
 - cold cathode gauge, 9, 102, 272, 320 il., 332
 - heat flow (with lunar drill), 9, 56, 102, 348, 358
 - laser ranging, 246, 256, 272, 310, 312-13, 342
 - lunar geology, 29, 155, 261, 272, 295
 - lunar soil thermometer, 318
 - lunar surface magnetometer, 9, 58, 143, 152, 332
 - mass spectrometer, 355
 - passive seismometer, 9, 58, 102, 256, 272, 295, 310, 312, 321, 329, 332, 341, 342, 348, 349, 352, 358, 360
 - solar wind spectrometer, 9, 58, 256, 272, 299, 319, 332, 342
 - suprathermal ion detector, 9, 58, 102, 272, 332
 - first flight model, 291
 - funds, 9, 302
 - geological tools, 56, 143
 - LM ascent stage, 56-57, 138
 - management assignments, 13-14, 30-31
 - mission assignments, 9, 59-60, 143, 207, 229-30, 245-46
 - modified design, 302
 - prototype test program, 131-32
 - radioisotope thermoelectric generator (RTG; SNAP-27), 56-57, 138-39, 146-47, 170, 214, 234, 319
 - sample collections (see also *Apollo 11-17* and Lunar samples), 143, 155, 207, 230, 245-46, 272, 295
 - weight, 60, 102, 138, 142, 214
 - Apollo Mission Planning Task Force, 21
 - Apollo Mission Simulator (AMS). See Simulators.
 - Apollo Orbital Science Photographic Team, 322
 - Apollo program, iv, vi
 - budget, 2, 11, 16, 127, 150, 205, 289, 325-26, 338, 410-12
 - change control, iii, 44, 128, 144, 157-58, 192-93, 204-05, 223-24, 236-37, 250, 257, 288
 - communications. See Communications.
 - concerns
 - crew safety, 22-23, 79-81, 110, 126-28, 144, 146-47, 159, 180-81, 196-98, 203, 207-08, 229, 236-37, 241
 - mission success, 110, 127-28, 146-47, 160, 236-37
 - costs, vi, 2, 16, 41, 127, 163, 289, 306, 410-11
 - CSM/LM configuration differences, 196
 - definition of program termination, 205
 - Design Certification Review Board. See Apollo Design Certification Review.
 - first manned flight, iii, iv, vi, 2, 42, 47, 51 il, 110, 117, 126-27, 139, 140, 218, 254, 257-59
 - flight requirements before lunar landing, 123
 - key program decisions, 191, 361
 - management assignments, 13-14, 30-31, 152-53
 - manned flight planning, iii, 2, 29-31, 41-42, 69, 81-83, 126-27, 138-40, 170, 182, 191, 218, 242-43, 254, 264, 382
 - two-burn lunar orbit insertion, 26-27, 232, 241
 - mission schedule, 12, 68-69, 163, 170-71, 191, 222, 242-43, 311, 325-36
 - objectives (see also Apollo missions and Appendix 5), 20, 140, 205, 207, 225, 243
 - photographic operations in flight, vii, 214, 226
 - priorities, 29, 116, 191, 207, 227
 - problems (see also Apollo 204 Review Board and AS-204), 45, 116, 144, 153-54, 205, 223-24
 - safety, 22, 29, 144, 196-98, 229
 - stress corrosion, 12, 48-49, 187, 191, 196-97, 199, 219, 281, 290
 - weight, 2, 21, 138, 139-40, 144, 154-55, 161-62
 - quality control and inspection audit, 87
 - reliability, vi, 110
 - spacecraft delivery schedules, 12, 126-27, 138, 144, 145-46, 151, 154, 161, 168, 211-12
 - test flight program, iii, 82, 138, 170-71, 182
 - TV. See Television.
 - vacuum chamber tests, 38, 39-40, 72, 184
 - Apollo-Saturn. See AS-201, etc.
 - Apollo Site Selection Board, 102, 182-83, 250-51, 300, 346
 - Apollo-Soyuz Test Project, vi, 362
 - Apollo Spacecraft Program Office (ASPO), MSC, 6, 33, 139, 149, 315
 - Apollo Spacecraft Configuration ("Change") Control Board (CCB), 44, 139-40, 157-58, 164, 174, 204-05, 211, 218, 222-24, 234, 268, 269, 288, 295, 304
 - CSM Panel, 164, 204-05
 - Government Furnished Equipment Panel (Board), 164, 165-66, 288

INDEX

- LM Panel, 10, 79, 164
- Procedures Panel (Board), 288
- Simulator Panel (Board), 164, 288
- Software Panel (Board), 164, 204-05, 288
- Apollo Spacecraft Investigation and Reporting Panel, 116, 163
- ASPO Manager
 - Lowe, George M. (April 1967-September 1969). See Lowe.
 - Lunney, Glynn S. (1972-1975), 362
 - McDivitt, James A. (September 1969-April 1972). See McDivitt.
 - Morris, Owen G. (April 1972-March 1973), 356
 - Shea, Joseph F. (October 1963-April 1967). See Shea.
- Assistant Program Manager, 75, 78-79, 83
- Assistant Program Manager for Flight Safety, 153
- Atmosphere Selection Task Team, 213
- Change Integration Group, 204-05
- Configuration Management Plan, 77, 204-05
- CSM Contract Engineering Branch, 133
- CSM Manager. See Kleinknecht, Kenneth S.
- CSM Project Engineering Div. (earlier, CSM Project Engineering and Checkout Div.), 133, 195-96
- LM Project Engineering Div. (earlier, LM Project Engineering and Checkout Div.), 195-96
- LM Program Office, 41
 - Manager, Carroll H. Bolender. See Bolender.
 - Manager, William A. Lee, 78-79
- Mission Simulator Office, 38
- RASPO (Resident ASPO)
 - Bethpage, N.Y., 7-8, 37-38, 189, 214, 268
 - Downey, Calif., 130, 151, 163, 174, 176-78, 189, 214, 251-52
 - KSC, 163
 - reorganized, 362
 - Systems Engineering Div., 83, 213, 219, 226, 300
 - Test Div., 214
- Apollo spacecraft systems (see also Command module, Command and service module, Service module, and Appendixes 2, 5, and 8), 248 il.
 - abort sequence, 203
 - certification, 191
 - communications. See Communications.
 - earth landing, 8, 117, 162, 169, 231, 260
 - electrical power, 2, 12, 23
 - emergency detection, 101, 217, 246
 - fuel cells, iv, 19, 49, 119-20, 137, 279
 - guidance and navigation (see also Computer), iv, 31-32, 70, 120, 127, 155, 161, 240
 - launch escape (LES), 10 il., 66, 67-68, 71, 175
 - ORDEAL, 37
 - oxygen purge, 147, 161, 163, 318, 319
 - parachute. See Parachute.
 - portable life support (PLSS), 161-62, 274, 294
 - stabilization and control, 70
 - suit. See Spacesuit.
 - water sterilization, 130, 215
- Apollo Special Task Team, 116, 117, 176-78, 190-91, 194-95, 197, 250
 - effectiveness, 252
 - mission ended, 117, 245
 - problems, 197, 199-200, 209, 212-13, 215, 219
- Apollo System Safety program, 116, 152-53
- Apollo telescope mount (ATM), iv, 31, 324
- Aquarius*. See *Apollo 13* and LM-7.
- Arabian, Donald D., 73, 283, 316
- Arlington National Cemetery, 67
- Arma Div., American Bosch Arma Corp., 37-38
- Armed Forces Institute of Pathology, 68
- Armitage, Peter J., 261
- Armstrong, Neil A., 2, 12-13, 117, 224, 264, 304-08 il.-10, 375, 377, 389, 408
- Arnold Engineering Development Center (AEDC), 21, 220
- ARO, Inc., 21
- AS-201 (Apollo-Saturn 201; also SA-201), 2, 10 il., 12, 100, 377, 401
- AS-202, 2, 20, 37, 43, 100, 380, 402
- AS-203, 2, 28, 100, 379, 401
- AS-204 (Apollo 1; see also Apollo 204 Review Board, CM and CSM 012, and *Apollo 5*), 51 il.
 - accident (fire), iii, 2, 63, 64 il., 67, 72, 84-85, 88, 111 il.-14, 134, 210-11, 249
 - cause, 68, 76, 79, 92, 93, 107, 111-13
 - autopsies, 63
 - backup crew suits, 71
 - combustible CM materials, 72-73, 79, 90-91, 94-97, 105, 111
 - communications, 70, 76, 103-07, 112
 - costs, 116, 126, 289
 - crew designations, 47, 52
 - deaths, cause of, 68, 80, 107-09, 112
 - Design Certification Review, 42-43, 47
 - designated Apollo 1, 100
 - EVA, 59
 - flight readiness review, 43
 - information dissemination, 68
 - launch escape system removal, 67, 68
 - launch vehicle (see also *Apollo 5*, AS-204), 47, 97, 116, 130, 171
 - Manned Space Flight Review, 42
 - objectives, 27, 47
 - planned first manned flight, 2, 47, 51 il.
 - reaction control system, 59
 - rendezvous, 29, 59
 - rescue, 59
 - service propulsion system, 59
 - spacecraft hazards, 66, 67, 72, 79, 93-94, 110, 111-14
 - spacecraft-lunar module adapter removal, 78
 - system validation flight, 29
 - tracking ship *Vanguard*, 44
 - training, 51 il.
- AS-205 (see also *Apollo 7*), 43, 191
 - CM lift-to-drag ratio, 43
 - crew debriefing requirements, 249
 - experiments, 52, 144-45
 - launch vehicle test history, 257
 - schedule, 170-71
 - spacecraft/S-IVB rendezvous, 29-30, 142, 258
 - system validation flight, 29, 171
 - tracking ship support, 44
- AS-205/208, 52, 56
- AS-206, 68-69, 76, 162, 170-71, 229
- AS-206/207, 28
- AS-207, 6, 7, 12
- AS-207/208, 6, 7, 12, 28, 29-30, 52, 54
- AS-208, 6, 7
- AS-258, 60
- AS-278A, 44

INDEX

- AS-278B, 44
- AS-500-F (Apollo-Saturn V F; also SA-500-F), 23 il.
- AS-501 (see also *Apollo 4*), 48
 ad hoc safety group, 146
 attitude maneuver, 56
 checkout, 66, 143
 designated Apollo 4, 100, 130
 launch preparation, 66, 142
 photography, 183
 recovery area, 52-53, 172
 schedule, 52, 68-69, 76
- AS-502 (see also *Apollo 6*), 52, 68-69, 76, 170-171, 183, 191
- AS-503 (see also *Apollo 8*), 191, 237, 255 il.
 crew assignments, 56
 Crew Safety Review Board, 267
 hardware, 175, 243-44, 257, 268-69
 Level II Configuration Control Board, 257
 lightning strike, 267
 mission, 170-71, 179, 222, 237-41, 242-44, 275-77
 objectives, 242-43
 payload weight, 243-44
 pogo, 244, 247
 recovery area, 52, 277
 rollout, 253, 255 il.
 Saturn V, 179, 253, 255 il.
 S-IVB stage explosion, 2, 61-62, 75
- AS-503D, 28
- AS-503F, 28
- AS-504 (see also *Apollo 9*)
 crew assignments, 243
 designated Apollo 9, 268
 M&SS experiment, 30
 mission, 170-71, 243-44, 282, 286-87 il.
 rollout, 278
 Saturn V/CSM 104/LM-3 assigned, 243
 test and checkout problems, 237
 TV, 50, 286
- AS-505 (see also *Apollo 10*)
 designated Apollo 10, 268
 launch vehicle flight objectives, 299-300
 mission, 171, 282, 291, 296-97 il.-98
 problem areas, 299-300
 schedule, 171, 282
- AS-506 (see also *Apollo 11*), 171, 308 il.
- AS-507 (see also *Apollo 12*), 171
- AS-508 (see also *Apollo 13*), 171
- AS-509 (see also *Apollo 14*), 171
- AS-510. See *Apollo 15*.
- AS-511. See *Apollo 16*.
- AS-512. See *Apollo 17*.
- AS-515, 326
- Aseptic sampler, 293
- ASPO. See Apollo Spacecraft Program Office.
- Associated Press, 304
- Astronaut training
Apollo 11, 229-30, 273, 301, 303-05
 biology, 116, 119
 Block II Training Plan, 119
 C prime mission, 243
 centrifuge, 292-93
 CM simulator, 304
 egress, 53 il., 94-95, 269, 278, 280 il.
 EVA, 304, 329-30
 experiments, 38, 116, 119, 273, 303-04
 extravehicular mobility unit, 270-71, 278
 fire, 159-60, 274-75
 launch abort, 22, 203, 269
 lunar handtools, 273
 lunar landing research vehicle, 148
 lunar landing training vehicle, 34, 148-49, 174, 272, 302, 304
 lunar samples, 118, 329-30
 preflight transition, 34
 slide wire, 278, 280 il.
 thermal vacuum, 38-39, 40
 water immersion, 298
- Astronauts. See individual names and Appendixes 3, 4, and 6.
- Atchison, W. B., 137
- Atkins, John R., 74
- Atlantic Ocean, 44, 52, 131, 282, 287
- Atlas-Agena launch vehicle, 12-13, 377-81
- Atlas-Agena B, 381
- Atlas-Agena D, 34, 49, 379-83
- Atlas-Centaur, 24, 40, 378, 380-84
- ATM. See Apollo telescope mount.
- Atomic Energy Commission, 57, 234
- Atomic generator. See Apollo Lunar Surface Experiments Package, radioisotope thermoelectric generator.
- Atwood, J. Leland, 240, 326
- Autonetics Div., North American Aviation, Inc., 81

B

- B-52 aircraft, 192, 213
- Babb, Gus R., 187
- Babbit, D. O., 85
- Back contamination (see also Interagency Committee on), 295
- Bailey, John F., 73, 146
- Bartley, William F., Jr., 66
- Battersby, Frank X., 27, 35, 38, 42, 189, 245, 252
- Battin, Richard H., 185
- Bausch & Lomb, Inc., 152
- Baxter, Lt. Col. William D. (USAF), 66, 70, 71
- Baylor University College of Medicine, 22
- Bean, Alan L., 319-21 il.-22 il., 375, 391, 408
- Beech Aircraft Corp., 333, 339, 372
- Beddingfield, Sam T., 174
- Bell, Persa R., 313
- Bell Aerosystems Co., div. of Bell Aerospace Corp.
 fire, 124
 LM ascent engine, 35, 117, 149, 178-79, 180, 189, 194, 227-28, 372
 lunar landing training vehicle, 55, 148-49
 Test Center, Porter, N.Y., 124
 Test Facility, Wheatfield, N.Y., 124
- Bellcomm, Inc., 18, 26-27, 59, 181, 190, 283, 299, 301, 326
 guidance computer, 31-32, 185, 203-04
- Belmont, Calif., 209
- Bendix Corp., Aerospace Systems Div. (formerly Bendix Systems Div.), 13, 37, 57, 131-32, 138-39, 295, 302
- Benner, R. L., 70
- Beregovoy, Georgy T., 386
- Bergen, William B., 201, 211, 228, 239, 337
- Berkebile, M. John, 87
- Berry, Charles A., 19, 60, 62, 72, 78, 80, 134-35, 145, 158, 165, 193, 201, 246, 291, 331 il.
- Bethpage, N.Y., 28, 35, 51 il., 148, 214, 234, 238
- Billings, Charles R., 280 il.
- Binghamton, N.Y., 53

INDEX

- Biorad, 152
 Black, Dugald O., 143
 Bland, William M., Jr., 73, 121-22, 152, 170
 Blasingame, B. Paul, 240
 Blount, Robert L., 87
 Boeing Co., The, 17, 141, 201, 214, 240
 lunar roving vehicle contract, 316, 325, 344
 Bogart, Frank A., 77
 Boilerplate (BP), 146
 BP-19, 199-200
 BP-30, 175, 179
 BP-1224, 159, 184-85, 201-02, 209, 219
 BP-1250, 184-85, 201-02
 flammability testing, 159, 184-85, 201-02, 209, 219
 Bolender, Carroll H.,
 LM Manager, ASPO, MSC, 148, 155, 157-58, 202,
 206, 223-24, 226-28, 230, 235, 236, 238, 256,
 268, 277
 OMSF, NASA Hq., 44, 70, 77
 Bond, Aleck C., 81, 101, 153, 193, 201, 225, 261
 Borman, Frank
 Apollo 8, 239, 275-77, 373, 374, 386
 Apollo 204 Review Board, 63, 65, 69-70, 71, 73-74,
 78, 81
 Block II Redefinition, CSM, Task Team, 126,
 128-30, 133, 243
 crew assignments, 41-42, 243, 308
 world records, 373, 374
 Bosworth, George L., 224
 Bottomley, T. A., Jr., 18
 Bowman, Julian B., 77, 239
 Bradford, William C., 166
 Bradley, Mark E., 44-45, 156
 Brady, A. L., 38
 Brand, Vance D., 336 il., 408-09
 Brendle, Harmon L., 207
 Bromberg, Jack, 62
 Brooks Air Force Base, Tex., accident, 66, 68
 Broome, Douglas R., 126, 205
 Brown, Ashmun, 77
 Brubaker, W. C., 181
 Buckley, Charles L., Jr., 74
 Buffalo, N.Y., 55
 Bullard, James L., 8
 Bunker, George M., 240
 Burch, J. A., Jr., 85
 Bureau of Mines, 65, 69, 75, 78, 97, 219
 Burke, Walter F., 240
 Burnham, D. C., 36
 Burns, Howard D., 267
 Burt, Robert P., 195
 Bush, Leon R., 185
 Butler, P. A., 7
 Byington, Harry W., 48
- C**
- C-133A aircraft, 169
 Calahan, Hubert D., 101
 Calio, Anthony J., 313, 327
 Camera
 contract, 36
 lunar closeup stereo, 275, 293, 311, 324, 327
 television
 CM, CSM, 134, 168-69, 218, 277, 341-42
 color, 302, 306-07, 347
 LM, 134, 168, 277, 340-41
 test requirements, 134, 168-69, 218
 Cape Kennedy, Fla. (Cape Canaveral before Nov. 28,
 1963, and after Oct. 9, 1973), 10, 11, 24, 34, 35, 37,
 40, 49, 117, 257
 Carhart, Homer, 70-71
 Carr, Gerald P., 408
 CASE (Coordinated Aerospace Supplier Evaluation),
 327
Casper. See *Apollo 16* and CSM 113.
 Catterson, A. Duane, 158
 Cernan, Eugene A., 56, 133, 291, 296-97 il.-98,
 357-60, 363, 374, 378-79, 388, 399, 408-09
 Chaffee, Roger B., iii, 2, 47, 51 il., 63, 67, 68, 100,
 112
Challenger. See *Apollo 17* and LM-12.
 Chamberlin, James A., 166, 176, 269, 357
 Chandler, George P., 363
 Chao, E. C. T., 313
 Chapman, Philip K., 409
 Chauvin, Leo T., 161
 Cheatham, Donald C., 25
 Cherry Pat, 189
 Chin, E. S., 146
 Christensen, Everett E., 22
 Chrysler Corp., 32, 52, 240
 Civil Aeronautics Board, 71
 Clark, John F., 146
 Clark, S., 9
 Clemmons, S. B., 85
 Close, William H., 152
 CM (Command module; see also CSM, Apollo
 spacecraft, and Appendix 8), iv, 14
 AS-501 pressurization, 66
 atmosphere
 back contamination, 22
 oxygen and two-gas, iii, 67, 72, 73, 78-80, 81,
 93, 99, 105-06, 109, 113, 116, 122-23, 145,
 168, 171-72, 193, 201-02, 204, 209, 210-11,
 213, 214-15, 219, 229
 toxic, 80, 108-09, 112, 114, 229
 cold storage compartment, 294
 couches, 33, 37, 66, 70, 71, 79, 98-99, 138, 218
 crew compartment, 99, 122, 162
 crew nomenclature, 52
 delivery, 19, 68, 154
 emergency medical kit, 6
 flammable materials, iii, 72-73, 79-80, 90-91,
 94-97, 101, 105-06, 111, 114, 116, 120-21, 125,
 129-31, 136-37, 145, 159, 181, 183-84, 229
 flammability testing, 79, 80, 95-96, 113, 136-37,
 145-46, 168, 171-72, 203
 fire extinguishers, 101, 129, 159, 229
 fire hazard (see also AS-204 and Apollo 204 Review
 Board), iii, 23, 66, 72-73, 79-80, 110-14, 201,
 203
 hatch, 72, 79-80, 85, 93-94, 106, 108, 110, 112,
 154 il., 162, 217, 286, 292
 heatshield, 8, 10, 37, 160-61, 162, 172-73, 217,
 260, 340, 380
 CM 012, 8, 77, 83, 89-90
 lift-to-drag ratio, 43
 mockup, 32, 48, 79, 99, 113, 122, 128, 146
 reentry, iii, iv, 10, 72, 160-61, 172-73, 216-17,
 258-59, 277, 332, 380, 384
 sea-qualification test, 45 il.

INDEX

- simulator, 40
- solder joints, 79, 97, 120, 127, 142, 189
- stowage, 151
- system reusability, 274
- tunnel insulation, 306
- water sterilization system, 130, 215
- weight, 8, 15, 72, 83, 138, 161-62
- CM 002B, 227
- CM 007, 11, 12, 19, 45 il., 117, 217-18
- CM 011, 2, 8, 19, 24, 37, 380
- CM 012 (see also Apollo 204 Review Board and CSM 012), 64 il., 111 il.
 - aft heatshield removal, 77, 83, 89
 - Apollo 1 designation, 100
 - earth-landing system, 8
 - fire. See AS-204.
 - inspection, 72-73, 125
 - lift-to-drag ratio, 43
 - launch escape system removal, 67-68
 - rupture, 83, 89-90, 110
 - SM separation, 77
 - Space Vehicle Plugs-Out Integrated Test, 89
 - weight, 8
- CM 014, 5, 8, 68, 71, 97, 111 il., 125, 128, 227
- CM 017 (see also CSM 017 and Apollo 4), 26, 173 il.
- CM 020. See CSM 020 and Apollo 6.
- CM 2S-1, 61
- CM 2TV-1 (see also CSM 2TV-1), 60, 126-27, 195, 211, 221
- CM 101 (see also CSM 101 and Apollo 7), 80, 120, 142, 181, 208, 230, 248 il.
- CM 102, 145-46, 208-09, 227, 235
- CM 103 (see also CSM 103 and Apollo 8), 195, 198-99, 272-73
- CM 104 (*Gumdrop*). See CSM 104 and Apollo 9.
- CM 106 (*Charlie Brown*). See CSM 106 and Apollo 10.
- CM 107 (*Columbia*). See CSM 107 and Apollo 11.
- CM 108 (*Yankee Clipper*). See CSM 108 and Apollo 12.
- CM 109 (*Odyssey*). See CSM 109 and Apollo 13.
- CM 110 (*Kitty Hawk*). See CSM 110 and Apollo 14.
- CM 111 [used for ASTP], 145-46
- CM 112 (*Endeavor*). See CSM 112 and Apollo 15.
- CM 113 (*Casper*). See Apollo 16.
- CM 114 (*America; Apollo 17*), 145-46, 357-60
- CM 115, 145-46, 356-57
- CM 115A, 165, 327, 356-57
- CM 116, 188
- CM 117, 188
- CM 118, 188
- CM 119, 188
- Cohen, Aaron, 126, 138, 213, 232, 269-70
- Cohen, Alfred, 7, 8
- Cohen, Jack H., 195
- Collins, Duncan, 71
- Collins, Michael, 42, 56, 304-10, 362, 373, 375, 389, 408
- Collins Radio Co., 372
- Colonna, Richard A., 222
- Columbia*. See Apollo 11 and CSM 107.
- Columbia University, 9
- Command and service module. See CSM.
- Command module. See CM.
- Communications, iv, 15, 49, 50, 209, 217, 256
 - CM 012, 61, 70, 76, 102-07, 112
- Computer, 117, 185, 203-05, 238, 250, 288, 372
 - flight test support, 7, 138, 288
 - guidance and navigation, 15, 31-32, 155, 185, 203-04, 238, 240, 318
 - LM, 31-32
 - RCA-110A, 279
 - Real Time Computer Complex, 7, 33
 - simulator, 33, 40, 53, 288
- Conductron Corp. (subsidiary of McDonnell Douglas Corp.), 152
- Conlon, John W., 143, 261
- Conrad, Charles ("Pete"), Jr., 56, 179, 224, 270, 319-20 il.-21 il.-22, 373, 375, 380, 391, 408
- Coons, D. Owen, 261
- Cooper, L. Gordon, Jr., 291, 373, 408
- Coordinated Aerospace Supplier Evaluation (CASE), 327
- Cornell University, 64, 69, 71
- Corning Glass Co., 185
- Cortright, Edgar M., 40, 163-64, 206, 210, 223, 332, 335, 340
- Cozad, James C., 23
- Craig, Jerry W., 101, 126, 186, 219
- Creer, Brent Y., 33
- Creighton, Henry C., 102
- Crew rescue, 53-54, 163, 170, 198
- Crew Safety Panel, 62, 75, 198
- Crew Safety Review Board, 223, 284
- CM (command and service module; see also CM, Apollo missions, Apollo spacecraft systems, and Appendix 8), 248 il.
 - apex heatshield, 172-73
 - Block I, 2, 10, 12, 23-25, 32, 37, 52, 413-19
 - Block II, 6, 11, 21, 24, 25, 32, 191, 232-33 il., 248 il.
 - launch support, 11, 191
 - modifications, 23, 24, 79-80, 127-28, 134, 138, 162, 292, 294, 301, 413-19
 - Block II Redefinition Task Team, iii, 116, 125-26, 128-30, 133, 136, 151
 - Block II Wiring Investigation Team, 126
 - boost protective cover, 248 il., 290-91
 - change control. See Apollo program, change control.
 - contract negotiations, 5, 132, 134, 140, 145-46, 294
 - coolant, 134-35
 - costs (see also Apollo program, costs), 306
 - crew compartment fit and function test, 129
 - crew nomenclature, 52
 - cryogenic gas storage system, 2, 8, 12
 - delivery schedule, 12, 19, 68, 126-27, 134, 136, 138, 140, 144, 145-46, 154, 211-12, 222-23
 - Design Certification Review. See Apollo Design Certification Review Board.
 - DITMCO (inspection process), 129
 - dynamic load testing, 241
 - electrical power system, 2, 12, 14, 23, 70-71, 116, 120-21, 123, 162, 248 il.
 - circuit breakers, 65, 120-21, 123, 130-31
 - wiring, 37, 79-83, 92-93, 101, 102, 105-07, 111, 113-14, 120-21 il., 126, 128, 129-30, 132-133, 135 il., 136-37, 141 il., 162, 183-87, 200-02, 208
 - coax cable, 181, 183-87, 201-02
 - emergency detection system, 62, 217
 - emergency egress, 80, 145, 105-06, 246
 - entry monitor system, 160-61, 164
 - environmental control system, 2, 22-23, 44-45, 145, 156, 161, 175-76, 197, 232-33

INDEX

- CSM 011, 19
- CSM 012, 70-71, 73, 79, 90-107, 111, 113-14
- CSM 101, 129, 232-33
- environmental test review, 200
- fire hazards (see also AS-204 and Apollo 204 Review Board), 22-23, 66, 128, 136-37, 159, 171-72, 203, 274-75
- fuel tanks, 24, 248 il.
- hardware discrepancies, 190
- land-landing capability, 260
- lunar orbital science package, 283, 328
- pogo, 227, 242, 254
- stress corrosion. See Apollo program, problems.
- tests (see also CM, flammability testing), 119-20, 122, 138, 140-41
 - boilerplate mockup, 79, 80, 122, 145, 146
 - vibration, 133-34, 140-41
- titanium tank, 12, 119-20
- TV (see also Apollo missions), 15-16, 17, 24, 25, 51, 168-69, 218, 273, 277, 302
- walk-down team, 306, 317
- water requirements task team, 205
- weight, 2, 8, 21, 138-40, 144, 149-50, 154-55, 161-62, 188, 290-91, 292
- CSM 007, 11, 12, 19, 45, 117, 217-18
- CSM 008, 12, 38-39, 146
- CSM 009 (AS-201 payload), 2, 10 il., 377
- CSM 011 (see also AS-202), 2, 8, 12, 19, 24, 37, 380
- CSM 012 (for Apollo 1; see also CM 012, Apollo 204 Review Board, and AS-204)
 - communications assembly, 61
 - Customer Acceptance Readiness Review, 44
 - earth-landing system, 8
 - entry procedures, 69-70
 - solder joint leaks, 120
 - special inspection, 125
 - testing, 5, 61
 - weight, 8
 - wiring, 79-81, 83, 92-93, 101, 105-07, 111, 113-14
- CSM 014 (see also CM 014), 5, 8, 125
- CSM 017
 - Apollo 4*, 172-73 il., 175
 - fuel cell tanks, 119-20
 - heatshield, 172-73, 217
 - inertial measurement unit, 120
 - mating with launch vehicle, 87, 120, 142
 - mission control programmer, 74, 81
 - operational checkout, 155
 - oxidizer tank replacement, 110
 - parachutes, 26
 - special inspection, 125
 - testing, 120, 125
 - wiring, 80-81, 87, 110
- CSM 020 (modified Block I), 216 il.
 - Apollo 6*, 179, 215-16 il.-17
 - data storage equipment, 207
 - delivery schedule, 136, 145-46
 - emergency detection system, 217
 - Flight Readiness Review Board, 207
 - fuel cell tank, 119-20
 - hatch, 136, 217
 - heatshield, 177
 - mission control programmer, 74-75
 - operational checkout, 155
 - reaction control system, 211
 - service propulsion system, 216
 - special inspection, 125
 - test restriction, 125
 - wiring, 155
- CSM 2TV-1 (thermal vacuum test vehicle No. 1), 221 il., 336 il.
 - constraint on CSM 101, 126-27, 129, 221
 - delivery schedule, 126-27, 151, 210, 211, 221, 222
 - flammable material, 184, 201-02
 - testing, 60, 126-27, 143, 195-96, 201-02, 210, 221 il., 336 il.
- CSM 101 (first Block II CSM), 80, 233 il., 248 il.
 - Apollo 7*, 123, 126, 139, 242, 253, 257-58 il.-59
 - atmosphere, 80, 116, 201-02, 209
 - changes (see also CSM, Block II), 80, 139, 164, 222, 413-19
 - crew safety, 80, 246, 249
 - Customer Acceptance Readiness Review, 181
 - delivery schedule, 126-27, 146, 151, 181, 211-12, 222, 249
 - Design Certification Review, 209, 232, 241
 - entry monitor system, 161, 164
 - experiments, 139, 144-45
 - fire extinguishing briefing, 274-75
 - flight readiness review, 241-42, 279-80
 - high-altitude abort procedures, 246
 - KSC receiving inspection, 230
 - mating with launch vehicle, 230, 242
 - parachutes, 139, 174, 218
 - plumbing, 136
 - reaction control system, 166-67, 177-78, 230, 258
 - rendezvous, 88, 123, 139, 140, 142, 258
 - service propulsion system, 208-09, 220, 258
 - solder joints, 120, 142
 - special inspection, 125
 - testing, 120, 129-30, 201-02, 257, 261-62, 274-75
 - toxicological evaluation, 229
 - TV, 218, 258-59
 - wiring, 80, 102, 120-21, 126, 129-30, 132-33, 135 il., 136-37, 161, 162, 208
 - coax cable, 181, 183-85, 201-02
- CSM 102, 145-46, 208, 208-09, 227
 - deletion from manned program, 235
- CSM 103
 - altitude chamber test, 253
 - Apollo 8*, 162, 168, 237-44, 272-73, 275-76 il.-77
 - C prime mission objectives, 242-44
 - coax cable, 186-87
 - Colossus computer program, 238
 - CSM 103 vs. 106 configuration study, 238-39
 - delivery schedule, 126-27, 145-46, 162, 211-12, 222
 - discrepancy reports, 278-80
 - fire extinguishing briefing, 274-75
 - high-gain antenna, 238, 244
 - operational checkout, 251-52
 - parachutes, 218, 277
 - plumbing system, 199
 - service propulsion system, 268, 272-73, 276-77
 - Special Task Team for Spacecraft 103 Contamination Control, 195, 198-99
- CSM 104 (*Gumdrop*)
 - Apollo 9*, 264, 282, 286-87 il., 388
 - checkout, 251-52, 262
 - coax cable, 183-84, 186-87
 - crew, 239, 243, 286-87
 - delivery schedule, 186-87, 211-12
 - docking with LM, 264, 286, 388
 - TV, 273, 277, 286
- CSM 105, 140-41, 145-46

INDEX

- CSM 105R, 145-46
 CSM 106 (*Charlie Brown*)
Apollo 10, 264, 279, 282, 296-97 il.-98, 388-89
 changes, 164
 coax cable, 186-87
 CSM 103 vs. 106 configuration study, 239
 delivery schedule, 145-46, 186-87
 electrical harness, 186
 high-gain antenna, 238
 CSM 107 (*Columbia*), 121 il.
Apollo 11, 282, 306-10, 389
 back contamination, 301, 312
 changes, 164
 coax cable, 186-87
 delivery schedule, 145-46, 186-87
 Flight Readiness Review Board, 301
 preservation, 310
 radiation survey, 289
 CSM 108 (*Yankee Clipper; Apollo 12*), 145-46, 282, 319-22, 391
 CSM 109 (*Odyssey*)
Apollo 13, 264, 282, 329-40, 392
 delivery schedule, 145-46
 SM oxygen tank rupture, 330 il., 331-40, 392
 CSM 110 (*Kitty Hawk; Apollo 14*), 145-46, 219, 265, 317, 341-43 il., 394
 CSM 111 [used for Apollo-Soyuz Test Project], 145-46, 219
 CSM 112 (*Endeavor; Apollo 15*), 145-46, 219, 265, 344, 347-49 il.-50, 396
 CSM 113 (*Casper*)
 accident, 356
Apollo 16, 265, 328, 352-56, 397-99
 delivery schedule, 145-46
 lunar orbit science, 328, 354, 355 il.
 CSM 114 (*America; Apollo 17*), 145-46, 357-60, 399-400
 CSM 115, 145-46, 356-57
 CSM 115A, 165, 327, 356-57
 CSM Configuration Control Panel, 77
 CSM Flight Readiness Review Board, 207, 279-80, 301
 Cunningham, R. Walter, 41-42, 53 il., 116, 133, 257-58 il.-59, 374, 385, 408
- D**
- Daddario, Congressman Emilio Q., 81
 Dalmo Victor, div. of Textron, Inc., 209, 212
 David Clark Manufacturing Co., 17
 Davidson, William L., 59
 Davin, Edward M., 14
 Davis, Don D., Jr., 161
 Davis, Lt. Gen. Leighton O. (USAF), 44
 Day, LeRoy E., 27, 88, 196, 267, 293
 Debus, Kurt H., 46, 62, 71, 77, 124-25, 146, 148, 170, 237, 238-39, 281, 299, 317 il.
 Deep Space Net Tracking Station, Woomera, Australia, 150
 Defense, Department of (DOD), 17, 240
 Director of Defense Research and Engineering, 17
 Manager for Manned Space Flight Support Operations, 44
 mapping agencies, 17, 35
 Secretary of Defense, 234, 311
 Dennett, Armistead, 143
 Denver, Colo., 37
 Detroit, Mich., 52
 Dickenson, John D., 87
 Dillaway, Robert, 220
 Disher, John H., 25, 27
 Dobrovolsky, Georgy T., 395
 Domokos, Steve, 190
 Donlan, Charles J., 6, 212, 255 il.
 Donnelly, John P., 363
 Donnelly, Paul C., 71, 285 il.
 Dorman, B. L., 228
 Douglas Aircraft Co. (merged with McDonnell Aircraft Corp. into McDonnell Douglas Corp. April 28, 1967), 2, 61-62, 203
 Dover, Del., 42
 Downey, Calif. See North American Aviation Inc., Space Div., and North American Rockwell Corp., Space Div.
 Downs, W. R., 136-37, 195
 Doyle, Frederick J., 322
 Draley, Eugene C., 161
 Draper, C. Stark, 240
 Dryden, Hugh L., 132
 Dudek, J. S., 26
 Duff, Brian M., 304
 Dugan, W., 71
 Duke, Charles M., 217-18, 227, 329, 352-53 il.-56, 376, 397-98, 408-09
 Duncan, Robert C., 25-26, 31
 Dunn, Capt. Latimer E. (USAF), 63
- E**
- Eagle*. See *Apollo 11* and LM-5.
 Early Apollo Science Experiments Package (EASEP), 273, 295, 405
 Earth, distance from moon, 314
 Earth Resources Survey Program, 183
 Eastern Test Range, 28, 66, 70, 150, 170
 Edwards, Calif., 35 il.
 Edwards AFB, Calif., 20
 Eggers, Alfred J., Jr., 40
 Eggleston, John M., 62, 102, 187
 Eisele, Donn F., 41-42, 53 il., 116, 126, 133, 257-58 il.-59, 291, 374, 385, 408
 El Centro, Calif., 20, 160, 169, 180, 192, 213
 Ellington AFB, Tex., 19, 55
 Elms, James C., 40
Endeavor. See *Apollo 15* and CSM 112.
 Engine (see also Lunar module), 270
 F-1, 35 il., 43 il.
 J-2, 215, 222, 232, 249
 R4D, 361-62
 reaction control (see also Service module), 36, 177-78, 206
 vernier, 36
 England, Anthony W., 409
 Engle, Joe H., 336 il., 408-09
 Ernull, Robert E., 123
 Esenwein, George F., 357
 EVA. See Extravehicular activity.
 Evans, B. O., 240
 Evans, Brian, 27
 Evans, Llewellyn J., 27, 41, 166, 202-03, 234
 Evans, Ronald E., 357-60, 376, 399, 408-09
 Experiments (see also Apollo Lunar Surface Experiment Package and Appendixes 5 and 9), 2, 5, 24, 30-31, 139, 226, 301, 310, 328

INDEX

- D008--Radiation in Spacecraft, 144-45
D019--Simple Navigation, 139
High-Z Cosmic Ray, 246
light-flash, 352, 355, 358, 360
lunar environment visibility, 280, 348
lunar geological equipment, 29, 143, 295, 327
M005--Bioassays Body Fluid, 52, 139
M006--Bone Demineralization, 52, 144-45
M011--Cytogenic Blood Studies, 52, 144-45
M023--Lower Body Negative Pressure, 52, 144-45
mapping and survey system, 30, 360
microbial response, 356
neutron probe, 358
optical experiments evaluation, 52
pallet, 18, 37
passive microwave, 226
radar-laser altimetry, 47, 286, 360
S005--Synoptic Terrain Photography, 144-45
S006--Synoptic Weather Photography, 144-45
S015--Zero-g Single Human Cells, 54
S017--Trapped Particle Asymmetry, 54
S018--Micrometeorite Collection, 54
S019--UV Stellar Photography, 139
S020--UV-X-ray Solar Photography, 139
S027--X-ray Photography, 25
S031--Lunar Passive Seismology, 9, 58, 102, 256, 272, 295, 301, 310, 312, 321
S033--Active Lunar Seismology, 9, 102
S034--Lunar Tri-axis Magnetometer, 9, 58, 272
S035--Solar Wind (see also S080), 9, 272
S036--Suprathermal Ion Detection, 9, 58, 102, 348, 358
S037--Heat Flow, 9, 56, 123, 348, 358
S038--Charged Particle Lunar Environment, 102
S058--Cold Cathode Ionization Gauge, 102, 272, 320 il.
S059--Lunar Geological Investigation, 28, 245-46, 261, 272, 275, 295, 342
S068--Lunar Meteoroid Detection, 53
S078--Corner Reflector for Laser Ranging, 246, 256, 272, 310, 312-13, 342
S080--Solar Wind Composition, 9, 58, 246, 256, 272, 299, 319, 332, 342
S167--Sounding Radar, 328
S168--Lunar Electromagnetic Sounder, 328, 360
S169--Ultraviolet Spectrometer, 226, 360
S171--Infrared Scanning Radiometer, 47, 226, 360
S199--Traverse Gravimeter, 358
subsatellite, v, 226, 349, 355, 362, 396, 398-99
T004--Frog Otolith Function, 54
T033--Contrast Perception on Moon, 280, 348
T034--Color Perception on Moon, 280, 342
T035--Distance Estimation on Moon, 280, 348
Explorer 35 (IMP-E), 383
Extravehicular activity (EVA; see also *Apollo 9, 11, 12, 14-17*), 205
AS-204, 59
AS-503, 57-58, 168
Block I CSM, 59
Block II CSM, first flight, 139
Gemini, iii-iv, 208, 379, 381
planning for lunar landing mission, 59-60, 155, 168, 187-88, 202, 207, 207-08, 256-57, 260-61, 275, 284-85, 311-12, 316, 340-41
pre-lunar landing, 168
Soyuz, 387
world records (see also Appendix 3), 302-03, 316
Extravehicular mobility unit (EMU), 188, 253-54, 270-71, 278, 338 il., 343-44, 345 il.
- ### F
- F-1 rocket engine, 35 il., 43 il.
Faget, Maxime A., 6, 16, 19, 21, 33, 62, 63, 65-66, 71, 73-74, 80, 83, 101, 123, 130-31, 133, 142, 158, 160, 161, 163, 165-66, 169-70, 172, 175-76, 186, 193, 201, 220, 224, 230, 231, 246, 283-85, 288, 290, 362
Falcon. See *Apollo 15* and LM-10.
Fansteel Metallurgical Corp., Airtek Div., 171
Farrand mission effects projector, 151-52
Federal Aviation Agency, 65-66, 71
Fédération Aéronautique Internationale (FAI), 220, 302-03, 316, 373-76
Feltz, Charles H., 174
Filipchenko, Anatoly V., 390
Fire detection system, 101, 220, 290
Fire extinguisher, 101, 129, 159, 299
Fire hazards. See CSM, fire hazards.
Flammability Review Board. See Senior Flammability Review Board.
Flammability Test Review Board (MSC), 158
Fletcher, James C., 345, 363
Flight Mechanics Panel, 56
Guidance and Performance Sub-Panel, 56
Flight Research Center, 224
Flory, Donald A., 26
Fort Davis, Tex., 313
Fort Detrick, Md., 261
Fort Hood, Tex., 20
Foster, John S., Jr., 17
Framingham, Mass., 40
Franklin, George C., 34
Frazer, Robert R., 281
Freeman, J. W., Jr., 9
Freeman, Orville L., 151
Fullerton, Charles G., 409
Fullerton, Calif., 328
- ### G
- Gaithersburg, Md., 33
Gardiner, John S., 151
Gardiner, Robert A., 166, 318, 325
Garrett Corp., 44-45, 156
AiResearch Div., 2, 22-23, 44-45, 71, 129, 156-57, 175-76, 372
Garrett-AiResearch Safety Audit Review Board, 156-57
Garriott, Owen K., 408
Gasich, W., 194-95
Gates, Sally D., 408
Gavin, Joseph G., Jr., 27, 41, 137, 155, 157-58, 196-97, 212, 227, 236, 256, 313
Gay, C. C., Jr., 196
Geer, E. Barton, 64, 65, 73-74, 133, 143, 261
Gemini V, 373
Gemini VII, 12, 30, 373, 377
Gemini VIII, 2, 12-13, 15, 373, 377, 379
Gemini IX-A, 269, 278-79
Gemini X, 373, 379
Gemini XI, 7, 373, 380

INDEX

- Gemini XII*, 7, 381
 Gemini-Agena Target Vehicle (GATV), 12-13, 269, 377-81
 Gemini program, iii, iv, 7, 36, 72, 79, 148, 149, 166, 208, 254
 General Electric Co. (GE), 17, 45-46, 176, 194, 219, 240
 General Motors Corp.
 AC Electronics Defense Research Laboratories, 316
 AC Electronics Div. (AC Spark Plug Div.), 15, 31-32, 240, 372
 Allison Div., 252, 267, 372
 General Precision, Inc.
 General Precision Link Group, 38, 152
 Kearfott Products Div., General Precision Aerospace Group, 37
 Gentile, Samuel A., 271
 Geonautics, Inc., 15
 Gerke, Paul D., 138
 Gibson, Edward G., 408
 Gibson, Ralph E., 171
 Gibson, Thomas F., Jr., 204-05
 Gill, George, 219
 Gillespie, Warren, Jr., 19
 Gilruth, Robert R., 5-27, 30, 32-36, 42, 45, 48, 51, 55, 57-59, 62, 74, 97, 109, 121-25, 132, 139, 141, 146, 148-49, 151, 154, 157-61, 164, 165, 170-71, 174-78, 185, 191, 193, 201-07, 212, 214, 218, 220-230, 234, 238-39, 252, 254, 269-74, 278-81, 283, 288, 290, 294-99, 302, 304, 313, 322-26, 340, 345, 351
 Gisel, William G., 178
 Gleaves, J. D., 85
 Glynn, Philip C., 73
 Goddard Space Flight Center, 31, 44, 146, 289
 Godfrey, Roy E., 318, 325
 Goldenburg, Allan R., 102
 Goldstone, Calif., tracking station, 24, 50, 256, 296, 304, 319
 Goodwin, Glen, 161
 Goodyear Aerospace Corp., 165
 Gorbatko, Viktor V., 390
 Gordon, Richard F., Jr., 56, 319-21 il.-22, 373, 375, 380, 391, 408-09
 Goree, Jesse F., Jr., 73, 164, 204
 Gorman, Harry H., 357
 Gossick, Lee, 21
 Gottlieb, Peter, 293
 Government Accounting Office (GAO), 189
 Government-furnished equipment configuration and control panel, 10, 324
 Grau, Dieter, 241
 Gray, Edward Z., 159, 187
 Gray, Wilbur H., 174, 177
 Green, Richard J., 14
 Griffin, A., 74
 Griffith, J. G., 32
 Grimwood, Hilda J., xv
 Grimwood, James M., xiv, xv
 Grissom, Virgil I., iii, 2, 47, 63, 67, 68, 100, 112
 Group for Lunar Exploration Planning (GLEP), 187, 300
 Grumman Aircraft Engineering Corp. (GAEC)
 contract, LM, 9, 41, 372
 cost control, 9, 17, 27, 41
 delivery schedule, 9, 10, 14, 132
 government-furnished equipment, 10
 ground support equipment, 7-8, 14, 17
 LM reconnaissance module, 313
 LM thermal shield, 27
 LM wiring harness, 137
 LM-4 and 5 study, 244-45
 mission effects projector, 151-52
 North American Aviation office, 29
 officials appointed, 27
 ORDEAL, 37
 Program Control Office, 27
 scientific equipment, 56-57, 138-39
 simulator, 53
 SLA access, 134
 stress corrosion, 196
 Super Weight Improvement Program (SWIP), 21, 158, 267
 test, 51 il.
 Guidance Software Task Force, 117, 185, 204, 250
Guinness Superlatives, 314
 Gulf of Mexico, 19, 45 il., 217-18
 Gurney, Congressman Edward J., 81
- ### H
- Hage, George H., 178, 198, 238-41, 294, 306
 Hagner, Donald R., 185
 Haise, Fred W., Jr., 329-32, 375, 392, 408-09
 Hale, T/Sgt Larry N., (USAF), 63
 Hamilton Standard Div., United Aircraft Corp., 273-74, 372
 Haney, Paul P., 164
 Hannigan, James E., 59-60
 Hanrahan, Dick, 185
 Hardy, Gordon H., 33
 Harlan, Charles S., 175
 Harmon, Richard G., 66
 Harrington, Charles D., 335
 Harrington, James F., III, 285 il.
 Harter, Allan, 143
 Hartsfield, Henry W., 409
 Haveg Industries, 219
 Hawaii, 172, 350
 Hawkins, J. W., 85
 Hawthorne, Calif., 37
 Hayes, Warren B., 171
 Hays, Edward L., 143
 Healey, John P., 181
 Health, Education, and Welfare, Dept. of, 151, 165
 HEAO (High Energy Astronomy Observatory), 324
 Heffron, W. G., 299
 Helgeson, B. P., 224
 Helicopter, 173 il., 277, 287, 309, 332
 Henize, Karl G., 409
 Hess, Wilmot N., 145, 183, 187-88, 207-08, 246, 250, 273, 282, 292, 295
 High Energy Astronomy Observatory (HEAO), 324
 Hinchman, K., 74
 Hinnens, Noel W., 190, 326
 Hjernevik, Wesley L., 55, 62
 Hock, Robert C., 356
 Hodge, John D., 7, 14-15, 71, 123, 198, 225, 250, 253, 261, 299, 313
 Holcomb, John K., 20
 Holzapfel, Richard H., 224
 Honeywell, Inc., Computer Control Div., 40, 372
 Horeff, Thomas G., 65, 70
 Horner, Richard E., 160, 174

INDEX

Houston, Tex., 46, 50, 67, 143, 278, 326, 342
 Hoyler, Wilburne F., 73, 283
 Hughes Aircraft Co., 25-26
 Humphreys, J. W., 345
 Hunter, Bob, 240
 Huntsville, Ala., 238, 241, 316
 Hurricane Gladys, 259 il.

I

Illinois Institute of Technology, 136
 Indian Ocean, 331
 Instrument unit, 2, 25, 28, 37, 190, 196, 241, 296
 Interagency Committee on Back Contamination, 22,
 151, 165, 283, 298-99, 305-06, 312, 314, 317, 345
 Intercenter Coordination Panels, 198
 Interior, Dept. of the, 69, 78, 151, 165
 International Aeronautical Federation. See *Fédération
 Aéronautique Internationale*.
 International Business Machines Corp. (IBM), 7, 33,
 185, 203-04, 240
 International Latex Corp., 58, 274
Intrepid. See *Apollo 12* and LM-6.
 Irwin, James B., 347-50, 376, 395-96, 408-09
 Itek Corp., 151-52

J

J-2 engine, 215, 222, 232
 James, Lee B., 132, 222, 235, 238-41, 244, 249, 251,
 294, 300, 345
 Jeffs, George W., 64, 65-66, 69, 71, 74, 174, 193, 222,
 294, 306, 322, 327, 328
 Jenkins, Morris V., 59-60, 123
 Jet Propulsion Laboratory (JPL), 9, 24, 35-36, 293,
 315
 Johnson, Caldwell C., Jr., 292
 Johnson, President Lyndon B., 82, 361, 362
 Johnson, Robert E., 158
 Johnson Space Center. See *Manned Spacecraft Center*
 (renamed JSC Feb. 17, 1973).
 Johnston, Col. Edward H., (USA), 63
 Johnston, Richard S., 101, 158, 166, 219, 295, 299, 312,
 314, 317, 327
 Jones, Jack A., 133, 136
 Jones, Sydney C., Jr., 120-21
 Joslyn, Allan W., 195

K

Kapryan, Walter J., 47-48, 179, 317 il.
 Kaskey, B., 59
 Kearfott Products Div., General Precision, Inc., 37
 Kelly, G. Fred, 70-71, 74
 Kelly, Thomas J., 27, 222, 230
 Kennedy, President John F., xiv, 23, 82, 264
 Kennedy Space Center (KSC), xv, 2, 6, 23 il., 45-46,
 148, 153 il., 255 il., 293, 338 il.
 Apollo Configuration Control Panel, 47-48
 AS-204 accident (see also *Apollo 204 Review Board*
 and AS-204), 63
 crawler-transporter, 23 il.
 Design Engineering Office, 280

Director of Launch Operations, 45-46, 70, 268-69,
 313
 Director of Spacecraft Operations, 64
 firing room, 285 il.
 KSC Apollo Program Manager, 44, 45-48, 179, 181,
 229
 launch and launch preparations. See *Apollo missions*.
 Launch Control Center, 293-94
 Manned Spacecraft Operations Building, 51 il., 77,
 78, 86
 Material Analysis Laboratory, 83
 Mission Briefing Room, 65, 69-70
 Pyrotechnic Installation Building, 68, 75-77, 98-99,
 101
 Safety Office, 280
 Simulator Building, 71
 Vehicle Assembly Building, 23 il., 134, 255 il., 278

Kent, Wash., 316
 Kerwin, Joseph P., 143, 261, 336 il., 410
 Khrunov, Yevegeny V., 387
 King, Elbert A., 26
 King, John W., 71
 Kingsbury, James E., 149
Kitty Hawk. See *Apollo 14* and CSM 110.
 Kleinknecht, Kenneth S., viii, 19, 77, 101, 102, 109-10,
 116, 120, 126, 128, 133, 136, 144-151, 161, 166-67,
 169, 174, 177, 181, 186, 189, 190, 192-93, 195, 197,
 199-201, 204, 208, 212, 219, 231, 238-39, 249-52,
 262, 281, 289, 294, 301, 306, 322, 327
 Klopfenstein, Wayne, 222
 Kohlschutter Crater, moon, 353 il.
 Kollmorgen Corp., 152
 Kollsman Instrument Corp., 152, 372
 Komarov, Vladimir M., 382
 Kotanchik, Joseph N., 19, 26, 101, 120, 123, 137, 142,
 195, 211, 222, 238-39, 244, 284
 Kovach, Robert L., 9
 Kovitz, Carl, 59
 Kraft, Christopher C., Jr.
 MSC Director of Flight Operations, 19, 22, 28, 29-
 30, 52-53, 59, 77, 88, 123, 131, 138, 148, 158,
 175, 187, 193, 202, 204-05, 208, 224, 225, 231,
 237-40, 243-44, 246, 255 il., 288, 303, 315, 317-
 18, 323
 MSC Deputy Director, 323, 325
 MSC Director, 351, 356, 357, 362, 363
 Kranz, Eugene F., 123
 Kraushaar, William L., 324
 Kubasov, Valery, 390
 Kubat, Jerald R., 177
 Kudish, Henry, 316
 Kuehnel, Helmut A., 249
 Kupperian, James E., 146
 Kurtz, Herman F., Jr., 350

L

Lamont-Doherty Geological Observatory, 353
 Langley Research Center (LaRC), xv, 6, 12, 19, 24, 64,
 161, 185, 261, 332
 Apollo Block II CM/LM docking study, 74
 custodian of *Apollo 204 Review Board* material, 80,
 97

INDEX

- LM/S-IVB withdrawal study, 32, 48, 54, 74
- LOLA simulator, 15
- Lunar Landing Research Facility, 10-11, 34, 55, 212
- Lunar Orbiter Project Office, 42
- reaction control engine tests, 36
- Rendezvous Docking Simulator, 74
- Langseth, Marcus E., 9
- Lanzkron, Rolf W., 227
- Latham, Gary V., 353 il.
- Launch Complex 13, 34, 49
- Launch Complex 14, 12
- Launch Complex 19, 12
- Launch Complex 34, 10, 11, 37, 175, 257
 - AS-204 accident, 63, 65, 77, 89, 98, 112
 - manned flight certification, 191
- Launch Complex 37, 28, 134, 196
- Launch Complex 39
 - Pad A, iii, 172, 216, 275, 278, 286, 306, 319, 329, 341, 347, 352, 357
 - Pad B, 289, 296
- Launch escape system (LES). See Apollo spacecraft systems.
- Launch vehicle. See AS-201, etc.; AS-501, etc.; Atlas-Agena; Atlas-Centaur; Saturn; Scout; Thor-Delta; Titan II.
- Leak, John S., 71
- Lee, Chester M., 318, 322, 342, 350, 356, 362
- Lee, John B., 83, 166
- Lee, William A., 27, 34, 78-79
- LEM (lunar excursion module). See Lunar module.
- LEM Configuration Control Panel, 10
- LES. See Apollo spacecraft systems, Launch escape.
- Lewis, James L., 408-09
- Lewis Research Center, 65-66, 70-71, 150, 269, 336-37
- Liberty Bell 7*, 72
- Liccardi, A. L., 139
- Lick Observatory, Calif., 310
- Lilly, William E., 61
- Lind, Don L., 138, 408
- Lindberg, James P., Jr., 291
- Lindeman, Richard E., 126
- Link Group, General Precision, Inc., 38, 372
- Lippitt, Maxwell W., 101
- LM (lunar module; LEM, lunar excursion module, before May 1966), iv, 32-33, 34, 82, 190, 305 il.
 - abort capability, 14-15, 21
 - access on launch pad, 134
 - adapter. See SLA.
 - attitude control, 179-80, 271-72
 - AS-204-related changes, 157-58
 - AS-208, 7
 - ascent stage, 51 il., 262, 286, 301, 305 il.
 - cabin, 169-70, 213-14, 220-21, 282
 - engine, 35, 117, 149, 178-80, 189-91, 199, 223-25, 227-28, 252
 - manual control, 271-72
 - propulsion system, 14, 15, 123, 196, 202-03, 206, 286, 288-89
 - TV camera, 168-69
 - windows, 185, 190, 206-07
 - budget, 41, 127, 205, 235
 - capacity, 147
 - communications, 15, 49, 205-06, 312
 - contract, 7-8, 9-10, 14
 - delivery schedule, 127, 138, 168, 222-23, 235
 - descent stage, 27, 262, 283, 305 il.
 - ALSEP, 56-57, 139, 146-47, 383
 - engine, 36, 58, 190, 206
 - landing gear, 29, 57, 58, 230, 281
 - lunar TV camera, 168-69
 - propulsion system, 15, 48, 109, 123, 196, 202-03, 286-89
 - radioisotope thermoelectric generator, 56-57, 146-47
 - design certification, 191
 - design requirements, 29, 41, 147, 223-24, 282-83
 - docking control, iv, 271-72
 - electrical power system, 130-31
 - emergency medical kit, 5
 - environmental control system, 14-15, 58, 144
 - extraction from S-IVB stage, 32, 48, 54, 74, 218
 - fire-in-the-hole (FITH) test, 27, 116, 123, 188-89, 224-25
 - first manned flight (see also LM-3), 138
 - flags, 281
 - flammable material, 122, 130-31, 158
 - fuel system, 146-47
 - guidance computer, 31-32
 - heatshield, 27, 230
 - lunar samples, 282
 - mockups, 32, 35, 158-59
 - name change, 22
 - orbital rate drive electronics, 37
 - overall program review, 234-35
 - penetrometer, 24
 - rendezvous aids, 6, 10, 25-26, 235, 236
 - rescue, 53-54
 - simulators. See Simulators.
 - stress corrosion, 187, 191, 196-97, 206, 281
 - temperature, 27
 - tests (see also fire-in-the-hole), 5, 31, 138, 178, 212, 223, 233, 273
 - training aids, 34
 - TV, 15, 17, 25-26, 235, 236
 - unmanned landing, 283
 - weight, 2, 21, 37, 138, 139-40, 143, 154-55, 157-58, 161-62, 179-80, 235, 236, 292
- LM-1 (lunar module 1), 153 il.
 - Apollo 5*, 130, 191, 196, 199, 228
 - ascent engine, 194, 224
 - ascent propulsion system, 196, 203
 - Customer Acceptance Readiness Review Board, 144
 - descent propulsion system, 196, 202-03
 - development flight instrumentation harness, 132
 - guidance system, 196, 202-03
 - performance, 199
 - plumbing rework, 234
 - schedule, 132, 153 il.-54, 194
 - special inspection, 125
 - unmanned flight only, 44
 - windows, 190
- LM-2
 - alternative uses, 227, 233, 288
 - Apollo 8*, possible use, 238
 - delivery schedule, 44, 162, 168
 - drop test, 233, 294
 - fire-in-the-hole test, 116, 188-89
 - fire safety, 158-59
 - flight requirements meeting, 199
 - mannability, 44, 123, 148, 199, 202-03

INDEX

- mission and objectives, 162, 199
- pogo dynamics testing, 227, 233-34
- spacecraft director, 166
- test requirements, 178
- unmanned flight canceled, 199, 202
- LM-3 (*Spider*), 41, 230
 - Apollo 9*, 202-03, 264, 282, 286-87 il., 288-89
 - AS-503 mission assignment canceled, 242-43, 244
 - ascent engine, 180, 190-91, 227-28, 252, 262, 288-89
 - checkout, 58, 262
 - configuration, 41, 162, 164
 - delivery schedule, 162, 166, 168, 222-23, 242
 - descent engine, 262, 288-89
 - Design Certification Review, 199, 209, 236-37
 - docking with CSM, 286
 - mission, 162, 168
 - propellant line leak, 234
 - receiving inspection, 268
 - spacecraft director, 166
 - stress corrosion, 206, 281
 - toxicological evaluation, 229
 - TV camera, 168-69, 277
- LM-4 (*Snoopy*), 41
 - Apollo 10*, iv, 282, 296-97 il.-98
 - ascent engine, 227-28, 252
 - ascent stage, 291, 298
 - Customer Acceptance Readiness Review, 211, 244-45
 - delivery schedule, 168
 - insulation change, 169-70
 - lunar orbit mission constraint study, 244
 - minimum change, 41
 - receiving inspection, 268
 - spacecraft director, 166
 - stress corrosion, 206, 281
 - TV camera, 168-69, 277
- LM-5 (*Eagle*)
 - Apollo 11*, 282, 306-08 il.-09 il.-10
 - ascent engine, 227-28, 252
 - ascent stage, 116, 301
 - changes, 164
 - crew training, 273
 - Customer Acceptance Readiness Review, 211, 244-45
 - heatshield, 230
 - insulation change, 169-70
 - mission constraints, 244
 - spacecraft director, 166
 - stress corrosion, 206, 281
 - TV camera, 169, 277
 - window failure, 116, 185, 190, 206
- LM-6 (*Intrepid*)
 - Apollo 12*, 282, 316, 318-20 il.-21
 - changes, 164, 290
 - delivery date, 290
 - guidance, 312, 318
 - propellant tank test failure, 267
 - scientific payload weight, 292
 - stress corrosion, 290
 - TV camera, 169, 277, 319-20
- LM-7 (*Aquarius*)
 - Apollo 13*, 282, 329-30 il.-32, 336, 339
 - changes, 290
 - delivery date, 290
 - propellant tank test failure, 267
 - stress corrosion, 206, 290
 - TV camera, 169, 277
- LM-8 (*Antares*)
 - Apollo 14*, 341-43 il.
 - changes, 290
 - delivery date, 290
 - mobile equipment transporter, 324-25
 - stress corrosion, 206, 290
- LM-9, 224-25, 290
- LM-10 (*Falcon*), 290, 344 il.
 - Apollo 15*, 347-49
 - lunar liftoff, 346, 349
 - mobile equipment transporter, 324-25
 - TV camera, 169, 277, 348
- LM-11 (*Orion*), 290, 328
 - Apollo 16*, 352-55
 - flag kit, 352
 - mobile equipment transporter, 324-25
 - TV camera, 169, 277
- LM-12 (*Challenger*), 169, 277, 290
 - Apollo 17*, 357-59 il.-60
 - midsection assembly collapse, 271
- LM-13, 169, 277, 290, 339
- LM-14, 169, 277, 290, 327, 339
- LM TM-2, 51 il.
- LM TM-3, 35
- LM TM-6, 42, 158
- Lockheed Aircraft Corp., Lockheed Missiles and Space Co., 18, 37, 372
- London, 63, 314
- Long, Franklin A., 64, 69-70
- Los Angeles, 128, 311
- Lousma, Jack R., 408-09
- Lovell, James A., Jr., 74, 217, 243, 275, 329-32, 373-75, 381, 386, 392, 408
- Low, George M.
 - Acting NASA Administrator, 340, 345
 - ASPO Manager, 116, 119-24, 126-28, 130-42, 144, 149, 150-57, 159-65, 168-69, 174-78, 180-81, 183, 187-90, 192-209, 211-15, 218-44, 246-54, 256-57, 260-61, 268-75, 277-86, 288, 290-95, 299-302, 304, 306, 311, 314-15
 - MSC Deputy Director, 19, 21, 24, 36, 39-40, 55, 56, 58-59, 62, 67, 77, 81, 100-01, 116
 - NASA Deputy Administrator, 319, 324, 325, 331 il., 332, 337, 345, 356
- LRV. See Lunar roving vehicle.
- LTA-B (lunar module test article B; on *Apollo 8*), 175, 239, 243-44, 269
- LTA-2R (on *Apollo 6*), 207, 215
- LTA-3, 206, 227, 228
- LTA-4, 239
- LTA-8, 143-44, 158-59, 170, 195-96, 221, 230
- LTA-10, 42
- LTA-10R (on *Apollo 4*), 172
- Lucas, William R., 299
- Luna 9*, 377
- Luna 10*, 378
- Luna 11*, 379
- Luna 12*, 380
- Luna 13*, 380
- Luna 14*, 385
- Luna 15*, 389
- Luna 16*, 340, 392-93, 397
- Luna 17*, 340, 393
- Luna 18*, 396

INDEX

- Luna 19*, 397
Luna 20, 397
 Lunar and Planetary Missions Board, 202
 Lunar excursion module (LEM). See LM (lunar module).
 Lunar exploration (see also *Apollo 11-17*), vii, 282-83
 astronaut energy expenditure, 285-86
 ground rules, vii, 155, 186, 188, 207-08, 247, 311-12
 missions, vii, 301, 311-12
 plans, 40, 46, 155, 182, 186, 187-88, 190, 207-08
 program objectives, 278
 roving vehicle. See Lunar roving vehicle.
 Lunar exploration program (ALEM, ALEP, LEO, etc.), 205, 278, 322
 Lunar flyer development, 316
 Lunar International Observer Network (LION), 310
 Lunar landing mission (see also *Apollo 11-17*), 60-61
 basic missions, vii, 157, 182
 EVA, 245-49, 256-57, 260-61
 first mission, 116, 155, 190, 192, 207-08, 245-49, 256-57, 260-61, 272
 landing radar, 303
 LM insulation, 169-70
 LM testing, 178
 parking orbit, 60-61
 S-IVB restart requirement. See S-IVB.
 Saturn V performance, 60-61
 site selection. See Lunar landing sites.
 TV, 15-17, 50, 245-47, 256-57, 261
 Lunar Landing Research Facility (LLRF), 10-11, 34, 55, 212
 Lunar landing research vehicle (LLRV), 2, 148-49
 crew training, 55, 148-49, 212
 LLRV-1, 55, 224, 225, 260
 LLRV-2, 224
 Lunar landing sites. 6, 25, 34-35, 42, 50, 62, 102, 141, 150, 265, 300, 307-08 il., 311, 316, 319-20 il., 341-43 il., 346, 347 il.-49, 354, 358-59 il., 361 il.
 Lunar landing training vehicle (LLTV), 32, 340 il.
 contract, 55, 148, 171
 crew training, 11, 34, 55, 148-49, 171, 174, 340 il.
 defects, 148-49, 171
 Flight Readiness Review, 272, 289, 302
 flight test program, 32, 272
 ground tests, 224
 LLTV-1, 260, 264, 272
 LLTV-2, 289
 Lunar mapping and survey system (LMSS), 148, 214
 Lunar Mission Planning Board, 2, 62, 187-88
 Lunar Mobility Task Team, 312
 Lunar module. See LM.
 Lunar module test article. See LTA.
Lunar Orbiter I, 2, 34-35, 42, 62, 379
Lunar Orbiter II, 2, 49-50, 62, 102, 381
Lunar Orbiter III, 62, 381
Lunar Orbiter IV, 382
Lunar Orbiter V, 102, 116, 148, 150, 383
 Lunar Orbiter Project Office, 34-35, 42, 50
 Lunar polar orbit science package, 283
 Lunar Receiving Laboratory (LRL), 17, 22, 26, 31, 32, 38, 41, 54-56, 165, 261, 264, 279, 298, 302, 312, 314, 315
 Lunar roving vehicle (Lunar Rover), 328
 Apollo 15, v, 265, 346 il., 347 il., 348, 350-51
 Apollo 16, v, 265, 350, 353 il., 354
 Apollo 17, v, 265, 358-60
 approval, 264, 299, 301
 contract, 316
 MSFC management, 316
 power alternatives, 313
 requirements, 188, 303, 312, 325
 weight, 312, 318
 Lunar Roving Vehicle Task Team, 312
 Lunar sample program (see also Lunar Receiving Laboratory and Appendix 5), 39, 151, 165, 264, 265, 307, 313-14, 317, 319-21, 326 il., 341-42, 348-49, 350, 353 il., 354-55, 357, 358-60, 362
 Lunar Sample Review Board, 350
 Lunar samples, U.S.S.R., 392-93, 397
 Lunar Science Conference, 264, 326
 Lunar Science Institute, 325-26, 357
 Lunar Worm Planetary Roving Vehicle, 19
 Lundin, Bruce T., 225, 337
 Lunney, Glynn S., 362
 Lunokhod roving lunar vehicle, 340, 392
 Luskin, Harold T., 250

M

- McCandless, Bruce, II, 408-09
 McClanahan, Jack T., 51
 McClintock, John G., 83
 McCoy, Hugh E., 26, 71, 88
 McCullough, Hugh, 27
 McDivitt, James A.
 ASPO Manager, 314, 315, 318, 322, 324-26, 328, 332, 336-38, 341, 344, 346, 351, 356
 astronaut, 47, 56, 286-87, 289, 311, 374, 387, 408
 McDonald Observatory, Fort Davis, Tex., 313
 McDonnell Aircraft Corp. (McDonnell Co., October 1966-April 1967), 8, 18, 37, 65, 66
 Astronautics Co., 70
 McDonnell Douglas Corp. (merged from Douglas Aircraft Co. and McDonnell Co., April 28, 1967), 166, 240
 McNair, Lewis L., 56
 McNamara, J. P., 190-91
 McWhirter, Norris D., 314
 Madden, Robert T., 165
 Madrid, 50
 Magliato, Frank, 49
 Malley, George T., 64, 74
 Mallick, Donald L., 224
 Mangan, William D., 101
 Manned Flight Management Council, 56, 139, 199, 202-03, 249, 290
 Apollo 8 decision, 240-41
 Apollo 15 anomalies, 350
 Apollo capability augmentation requirements, 282-83
 first lunar landing activities, 247-49, 256-57
 "Hideaway" meeting, 46-47
 Manned Orbiting Laboratory (MOL), 128, 220
 Manned space flight awareness program, 210, 223, 314
 Manned Space Flight Experiment Board (MSFEB), 54, 130
 Manned Space Flight Network, iv, 15, 59, 272

INDEX

- Manned Spacecraft Center (MSC; Johnson Space Center after Feb. 17, 1973; see also Appendix 10)
- Advanced Spacecraft Technology Div., 16, 33
 - Advanced Systems Office, 57
 - Aircraft Maintenance–Quality Assurance Br., 224
 - Aircraft Operation Office, 224
 - Apollo 13* Investigation Team, 336, 337
 - Apollo Back Contamination and Configuration Control Office, 295
 - Apollo Entry Performance Review Board, 160–61
 - Apollo Mission Simulator Office, 38
 - Apollo Procurement Br., 25, 27, 35, 38, 42
 - Apollo-Soyuz Test Program Manager, 362
 - Apollo Spacecraft Program Office. See Apollo Spacecraft Program Office.
 - Apollo Test Office, 273–74
 - Applications Plans and Analysis Office, 57
 - Applications Project Office, 57
 - Assistant Director for Flight Crew Operations, 6
 - Assistant Director for Flight Operations, 7, 17
 - Astronaut Office, 224
 - Center Medical Office, 16–17, 70
 - Change Control Board. See Apollo Program Office.
 - Checkout and Test Div., 5
 - Chief of Center Medical Programs, 16
 - Crew Systems Div., 16, 76, 135, 269, 273–74
 - Crew Systems Laboratory, 101
 - Deputy Director. See Kraft, Christopher C., Jr.; Low, George M.; Sjoberg, Sigurd A.; and Trimble, George S., Jr.
 - Director. See Gilruth, Robert R., and (after Jan. 14, 1972), Kraft, Christopher C., Jr.
 - Director of Administration, 55
 - Director of Engineering and Development. See Faget, Maxime A.
 - Director of Flight Crew Operations. See Slayton, Donald K.
 - Director of Flight Operations (see also Kraft, Christopher C., Jr.), viii, 323, 325
 - Director of Medical Research and Operations, 135, 145, 165, 298, 305
 - Director of Science and Applications, 139, 145, 273
 - dynamic load testing, 241
 - Engineering and Development Directorate, 16–17, 120, 159, 163, 220, 221, 225, 283–84
 - Engineering and Development Manager, Experiments, 16
 - Engineering Office, 32
 - Environmental Medicine Office, 39
 - Experiments Program Office, 9, 24, 30
 - Experiments Review Group, 326
 - Flammability Test Review Board, 158
 - Flight Acceleration Facility, 292–93
 - Flight Control Div., 7, 14, 25, 60
 - Flight Crew Operations Directorate, 5, 25, 33, 88, 119, 120, 158–60, 202, 283–84
 - Flight Crew Support Div., 34, 38
 - Flight Experiment Selection Board, 19, 26
 - Flight Operations Directorate, 22, 123
 - Flight Program Review, 271–72
 - Flight Safety Office, 120–21, 153, 163, 225
 - Guidance and Control Div., 6, 33
 - Instrumentation and Electronic Systems Div., 121, 130–31
 - Landing and Recovery Div., 217
 - Lunar and Earth Sciences Div., 57
 - Lunar Exploration Working Group, 225
 - Lunar Receiving Laboratory. See Lunar Receiving Laboratory.
 - Lunar Surface Programs Office, 102, 234
 - Lunar Surface Project Office, 57
 - Lunar Surface Technology Br., 5
 - manned space flight mission responsibilities, 9, 31, 46–47
 - Medical Research and Operations Directorate, 165
 - Mission Control Center. See Mission Control Center.
 - Mission Planning and Analysis Div., 7, 179–80
 - Mission Operations Div., 10, 49, 102, 123
 - Operations Analysis Br., 60
 - organization changes, 16
 - Photographic Technology Laboratory, 315
 - Procurement and Contracts Div., 27, 35, 38, 42
 - Propulsion and Power Div., 191, 231
 - Reliability and Quality Assurance Office, 225
 - Reliability, Quality and Test Div., 120
 - renamed Lyndon B. Johnson Space Center (JSC), viii, 362
 - Rendezvous Analysis Br., 7
 - Science and Applications Directorate, 139, 165
 - simulators. See Simulators.
 - Space Environment Simulation Laboratory, 13 il., 39, 40, 143, 195, 270–71, 273, 326 il.
 - Space Medicine Directorate, 16
 - Space Physics Div., 57
 - Space Science Div., 16–17
 - Space Science Office, 16
 - Spacecraft Design Div., 292
 - Special Assistant to the Director for Organizational Affairs, 356
 - Structures and Mechanics Div., 121, 130–31, 136–37, 172, 211, 244
 - Systems Engineering Div., 8, 134, 139–40, 155, 158, 284
 - Technical Assistant for Apollo, 7, 15, 38, 58
 - Test and Operations Office, 57
 - Thermochemical Test Area, 122–23
 - Thermodynamics and Materials Br., 219
 - Water Immersion Facility, 147, 298
 - Mapping and survey system, 30
 - Mardel, Alfred D., 65, 74
 - Mariner program, 304
 - Mercury-Venus flights, 315
 - Markley, J. Thomas, 83, 87–88
 - Marquardt Corp., 206, 372
 - Marshall Space Flight Center (MSFC), 6, 22, 185
 - Apollo Program Manager, 181
 - Director. See von Braun, Wernher.
 - Director of Program Management, 345
 - Director of Quality and Reliability Assurance, 241
 - LRV simulator, 338
 - manned space flight mission responsibilities, 25, 30, 31, 35 il., 46–47, 316, 318
 - Mission Operations Manager, 235–36
 - planetary vehicle experiments, 47
 - Propulsion Div., 142
 - Research Projects Laboratory, 47
 - Saturn IB Program Manager, 253
 - Saturn Program Office, 35, 83, 316
 - Saturn V Program Manager, 235, 244, 278
 - Saturn V Test Management Office, 267
 - scientific survey module, 47
 - Martin Co., The, 18, 37, 240

INDEX

- Martin, James S., Jr., 185
 Mascons, 349
 Massachusetts Institute of Technology (MIT), 5, 9, 15, 31-32, 203-04, 240, 272
 Instrumentation Laboratory, 185
 Lincoln Laboratory, 5
 Mathews, Charles W., 65-66, 70, 182, 251, 255 il., 256-57, 318
 Mathews, Edward R., 322
 Mattingly, Thomas K., II, 329, 352-56, 376, 397, 408-09
 Mattson, Axel T., 10
 Mayer, John P., 7, 185
 Maynard, Owen E., 49, 62, 102, 138, 148, 183, 226, 249-51, 257
 Medcalf, W. M., 85
 Megow, Larry, 279
 Meisells, G. G., 26
 Menard, J. Z., 18
 Mercury program, iv, 72, 79, 116, 254, 351
 Merritt Island, Fla. See Launch Complex 39.
 Messina, Frank, 189
 Meyer, André J., Jr., 187
 Michel, F. Curtis, 9
 Michoud Operations plant, 35 il.
 Middleton, Roderick O., 87, 163, 168, 173, 183, 215, 221, 229, 237, 251, 294, 298
 Middletown, Ohio, 260
 Milwitzky, Benjamin, 300
 Mine Safety Appliance Co., 220
 Mission Control Center, MSC, 6, 7, 33, 50, 272, 278, 301, 304, 318, 331 il., 353 il.
 Mitchell, Edgar D., 291, 338 il., 341-43, 375, 394, 408-09
 Mobile equipment transporter (MET), 324-25, 338 il., 342-43 il.
 Mobile quarantine facility, 302, 303, 309, 313, 318, 321 il., 322
 Modisette, Jerry, 9
 Mohlere, Edward D., 177
 Moon (see also Lunar headings)
 Aristarchus, 310
 Censorinus, Crater, 311
 Central Bay area, 297 il.
 Copernicus, Crater, 311
 Descartes, 265, 346, 354, 361 il., 398
 distance from earth, 313
 Flag Crater, 354
 Fra Mauro, 300, 311, 361 il., 394
 Hadley-Apennine region, 265, 347 il., 348, 361 il., 396
 Hipparchus, 300
 Hyginus Rille, 311
 Kant region, 346
 Kohlschutter Crater, 353 il.
 Marius Hills, 311
 Mills Crater, 353 il.
 Ocean of Storms (Oceanus Procellarum), 25, 311, 319, 320 il., 391, 393
 Plum Crater, 353 il.
 Ray Crater, 398
 Schröter's Valley, 311
 Sea of Crises, 397
 Sea of Fertility, 393, 397
 Sea of Rains, 393
 Sea of Tranquility, 307, 308 il., 313, 361 il., 383, 389
 Sea of Vapors, 297 il.
 Sinus Medii, 141, 383
 Spook Crater, 354
 Sterno Crater, 399
 Stone Mountain, 398
 Survey Ridge, 398
 Taurus-Littrow region, 265, 311, 358, 359 il., 361
 Triesnecker Crater, 297 il.
 Tycho, Crater, 311
 Morea, Saverio F., 312, 313, 316, 318
 Morgan, D., 8
 Morris, Owen G., 134, 195, 328, 336, 356
 Morrow, Thomas F., 240
 Moscow, 63
 Moser, Robert E., 71
 MR-3 (Mercury-Redstone 3), 373
 Mrazek, William A., 200, 249-50
 Mueller, George E., 9, 13, 15-22, 25-27, 29, 32, 39-44, 47, 50, 54-57, 60-61, 65, 68, 71, 72, 76-78, 80, 83, 100, 110, 124-25, 130-36, 141, 146-50, 157, 163, 165, 174, 176, 185, 191, 194, 203-10, 218, 220, 228-30, 232-41, 250, 253-54, 255 il., 260-63, 271-75, 283, 288, 290, 293-96, 302, 304, 318, 322, 332
 Mullaney, Robert S., 27, 29
 Muller, Paul M., 293
 Murphy, Walter P., 71
 Myers, Dale D.
 NASA Associate Administrator for Manned Space Flight, 327, 335, 340, 345, 352, 356-57, 360, 362
 North American Apollo Program Manager, 49, 126-27, 134, 145, 151, 154, 162, 166-67, 174, 186-87, 190-94, 199-201, 208-15, 219, 231, 249-52, 260, 281
- N**
- NASA High Thrust Test Area, Edwards, Calif., 35 il.
 NASA/NAR ECS Safety Review Board, 156
 NASA/North American management meeting, 139
 NASA Task Team-Block II Redefinition, CSM. See CSM.
 Nathan, Ernest B., 249
 National Academy of Sciences, 151
 Committee on Toxicology, 135
 National Aeronautic Association, 220
 National Aeronautics and Space Administration (NASA; see also Appendix 10), 151, 361
 Acting Administrator, 271-73, 288, 340, 345
 Administrator. See Webb, James E.; Paine, Thomas O.; and Fletcher, James C.
 Associate Administrator for Advanced Research and Technology, 158
 Associate Administrator for Manned Space Flight. See Mueller, George E.
 Deputy, 116, 185
 Associate Administrator for Space Science and Applications (see also Newell, Homer E.; and Naugle, John E.), 336-37
 Chief Scientist (proposed), 324
 Deputy Administrator. See Seamans, Robert C., Jr.; Paine, Thomas O.; and Low, George M.
 Deputy Administrator for Planning, 13, 329

INDEX

- Director of Key Personnel Development, 351
 Flight Systems Office, 187-88
 Lunar and Planetary Programs Office, 5, 12
 Lunar Science Office, 187-88
 NASA Project Designation Committee, 22, 100, 110
 NASA Safety Director, 225
 North American Management Performance Award Board, 228
 Office of Advanced Research and Technology (OART), 12, 30-31
 Office of Manned Space Flight (OMSF), 30-31, 38, 185, 311
 Apollo Applications. See Apollo Applications program
 Apollo Mission Director, 30, 148
 Apollo Program Director. See Phillips, Samuel C.; and Petrone, Rocco A.
 Apollo Program Office, 24, 81, 125, 127, 187-88, 293, 315
 Lunar Exploration Office, 186, 187-88
 Apollo-Soyuz Test Project Director, 362
 budget, 41, 127, 205
 Director of Apollo Reliability and Quality, 127-28
 Director of Mission Operations, 22, 143, 203
 Office of Program Reports, 20
 Office of Space Science (OSS), 362
 Lunar Programs Office, 362
 Office of Space Science and Applications (OSSA), 13-14, 24, 30, 38, 152, 186
 Office of Tracking and Data Acquisition (OTDA), 31
 Planning Coordination Steering Group, 40
 reorganization, 185, 186-187
 Research Advisory Committees, 158
 Western Support Office, 61
 National Aeronautics and Space Council, 234, 361
 National Air and Space Museum, Smithsonian Institution, 362
 National Cathedral Space Window, 265, 363 il.
 National Space Club Salute to Apollo, 265, 361
 National Space Science Data Center, 351-52
 Naugle, John E., 165, 350, 357, 362
 Naval Research Laboratory, 70, 71
 Neal, James L., 14, 29, 212
 Neugebauer, Marcia M., 9
 New Orleans, La., 32, 35
 Newell, Homer E.
 NASA Associate Administrator, 202, 205-06
 NASA Associate Administrator for Space Science and Applications, 9, 16, 24, 26, 29, 35, 39, 55-56, 58-59, 102
 Nichols, Donald D., 73
 Nicks, Oran W., 5, 182, 250
 Niels, James F., 220, 265, 288, 307, 319, 329, 345, 363, 364
 Nikolayev, Andrian G., 393
 Nixon, President Richard M., 265, 288, 307, 319, 329, 345, 363, 364
 Nolan, James P., Jr., 203
 North American Aviation, Inc. (NAA; until Sept. 22, 1967). See North American Rockwell Corp.
 North American Rockwell Corp. (NR; 1967-1973; Rockwell International Corp. after Feb. 16, 1973), 69, 71, 121 il., 240
 Aerospace Systems Group, 158
 Design Requirements Group, 162
 Commercial Projects Group, 158
 Group Vice President—Aerospace and Systems, 337-38
 merged with Rockwell-Standard Corp., 158
 reorganization, 326, 338
 Rocketdyne Div., 35, 43, 117, 149, 178-80, 189-91, 194, 227-28, 252, 372
 Space Div. (Space Informations System Div. before May 1, 1967), Downey, Calif.
 accident, 61, 163
 Apollo 13 oxygen tank, 333-34, 338-39
 Apollo Special Task Team, 176-78, 194, 215, 250
 Bethpage, N.Y., office, 29
 Block II Redefinition Task Team. See CSM.
 CM, CSM arrival, 19, 68, 175, 221
 contract, 5, 80, 132, 133, 134, 137, 140, 145-46, 228, 249, 372
 SLA, 5, 134
 subcontracts, 44-45, 137, 228
 deficiencies, problems, 2, 8, 24, 48-49, 130, 137, 166-67, 176-78, 189, 190, 194, 215, 228, 249-50
 modifications, 24, 61, 80
 optical alignment sight, LM, 10
 quality control, 129, 166-67, 176-78, 190, 251-52
 renamed, 127
 Seal Beach plant, 61
 spacecraft delivery schedule, 12, 19, 126-27, 134, 136, 138, 145-46, 221, 249
 tests, 2, 126-27, 129-30, 146, 210, 214, 251-52
 failures, 48-49, 61, 169, 176-77, 194-95
 Tulsa, Okla., plant, 48
 North, Warren J., 34, 38, 180
 Northrop Corp., 160, 372
 Apollo Experiment Pallet program, 18, 37
 Northrop Space Laboratories, 18, 37
 Northrop-Ventura Co., tests, 26, 160, 169, 174, 192, 194-95, 198-200, 218-19
 Norwalk, Conn., 52
 Nunamaker, Robert R., 362
-
- OAO (Orbiting Astronomical Observatory), 324
 O'Brien, B. J., 9
 O'Bryant, William T., 14, 58-59
 Ocean of Storms (Oceanus Procellarum), 24, 311, 319, 320 il., 391, 393
 O'Connor, Edmund F., 20
Odyssey. See *Apollo 13* and CSM 109.
 Oliver, Lt. Col. Jephtha D., 225
 Orbital debris hazard, 208
 Orbital rate drive electronics for Apollo and LM (ORDEAL), 37
 Orbiter program, 6
 Orbiting Astronomical Observatory (OAO), 324
Orion. See *Apollo 16* and LM-11.
 Orlando, Fla., 81
 Ould, J. Wallace, 225
 Overmyer, Robert F., 409

INDEX

P

Pacific Ocean recovery area, 13, 37, 117, 173, 216, 264-65, 277, 282, 298, 307, 322, 331-32, 342, 350, 356, 360

Page, George F., 74

Paige, Hilliard W., 178, 240

Paine, Thomas O., 363

Acting NASA Administrator, 271-73, 288

Deputy NASA Administrator, 225, 239-41

NASA Administrator, 288, 296, 324, 326, 331 il., 332, 337, 338, 345

Parachutes, 160

Apollo 8, 277

Ballute system, 164-65

CSM 101, 174

drogue, 130, 162, 169, 180, 192, 213, 218-19

drop test failure, 169, 180, 192, 194-95, 213, 231

full-scale tests, 20, 180, 194-95

main, 139, 192

packing, 26, 174, 219

review, 174, 194-95, 197, 218-19

test vehicles, 169, 180, 192, 194-95, 199-200

Parker, Robert A. R., 409

Parmalee Plastics, 220

Pasadena, Calif., 293

Patsayev, Viktor I., 395

Patteson, Andrew W., 5

Paul, Hans G., 142

Peacock, James M., 8

Pegasus III meteoroid detection satellite, 286

Pendley, David B., 260, 269, 281, 325

Pennington, Jack E., 54

Peper, Craig K., 38

Perkin-Elmer Corp., 52

Perrine, Calvin H., Jr., 56, 123

Peterson, Donald H., 409

Petrone, Rocco A.

KSC Director of Launch Operations, 20, 24, 70, 190, 237-39, 268-69, 289, 305

NASA Apollo Program Director, 313-15, 325, 327-28, 332, 340-41, 344, 346, 351-52, 353 il.

Petynia, William W., 74, 75

Philco Corp., 152

Aeronutronic Div., 19, 24

Philco-Ford, 240

Phillips, Samuel C., 3, 6, 11-27, 31-32, 42, 45, 49, 52-54, 59-62, 65, 71, 77, 81, 87-88, 109-10, 120, 123-54, 157, 161-64, 168-70, 174, 178-82, 186-90, 193, 196-205, 208, 211, 214-27, 232-41, 245-61, 267-68, 271-74, 277-302, 311-13, 315, 331 il.

Phinney, Robert A., 350

Pickering, John E., 165

Pickering, William H., 36

Piland, Joseph V., 26

Piland, Robert O., 16, 19, 24, 47, 58, 62, 102, 183

Pinkel, I. Irving, 65, 70, 72, 150, 219

Pioneer (space probe), 324

Pitman, Clarence, 185

Platt, William E., 59

Pogue, William R., 408-09

Pohl, Henry O., 48

Polifka, Robert W., 48

Porcher, Arthur G., 280 il.

Portable life support system (PLSS), 60, 274, 282, 294, 315, 327, 343-44

Powell, James E., 143

Pratt & Whitney Aircraft Div., United Aircraft Corp., 137, 372

Pregnant Guppy (transport aircraft), 42

President of the United States, 82, 234, 265, 288, 307, 319, 345, 363, 364

space program objectives, 329

President's Scientific Advisory Committee (PSAC), 64, 69, 241

President's Space Task Group (STG), 293, 324

Press, Frank, 9

Preston, G. Merritt, 71

Project Mercury, iv, 72, 79, 116, 254, 351

Purser, Paul E., 15, 187

Q

Queijo, Manuel J., 15

R

Raines, Martin L., 87, 143, 145, 190, 197, 225, 241, 270, 290

RAM C-II, 385

RAM C-III, 393

Ranger program, 40

RASPO (Resident Apollo Spacecraft Program Office). See Apollo Spacecraft Program Office.

Rathke, C. William, 27, 137

Rawers, Lt. Col. James W. (USAF), 66

Raytheon Corp., 15, 372

RCA Corp., 25-26, 372

R4D rocket engine, 361-62

Reaction control system (RCS). See SM (service module).

Redondo Beach, Calif., 206

Reece, L. D., 85

Reentry F, 385

Rees, Eberhard F. M., 116, 117, 163, 174, 176-78, 190-91, 194-95, 197, 199-200, 209, 212-13, 215, 219, 238, 245, 250, 252, 329, 345

Reiffel, Leonard, 13, 54, 59, 142-43

Rice University, 9

Richard, Ludie G., 185, 238-39

Richardson, Keith A., 26

Rippey, James O., 408-09

Roberts, Conway H., 224

Rocchio, J. J., 31-32

Rocketdyne. See North American Rockwell Corp.

Rockwell-Standard Corp., 158

Rodano Research Corp., 6

Roosa, Stuart A., 217, 280 il., 341-43 il., 375, 394, 408-09

Rose, Rodney G., 59-60, 201

Ross, I. Miles, 31-32, 225

RTG. See Apollo Lunar Surface Experiment Package, radioisotope thermoelectric generator.

Rubey, William W., 350

Rudolph, Arthur, 173, 175, 221, 278

Rukavishnikov, Nikolay N., 394

Russell, Harold G., 125

Ryker, Norman J., Jr., 194-95

INDEX

S

- S-IB (Saturn IB first stage), 2, 28, 32, 35 il., 37
- S-IC (Saturn V first stage), 172, 215, 232, 244, 254, 291, 293
- S-II (Saturn V second stage), 61, 172, 215, 294
- S-IVB (Saturn IB second stage; Saturn V third stage), 25, 404
 - Apollo missions. See *Apollo 4-17*, launch; and *Apollo 7*, objectives.
 - AS-202, 2, 37
 - AS-203, 2, 28, 379
 - CSM separation and rendezvous, 29, 88, 123, 139, 140, 142, 235, 258, 286-87 il., 296, 329, 341, 348, 404
 - explosion, 2, 61, 62, 75, 109-10
 - impact on moon, 301, 329, 331, 341, 348, 352-53, 358
 - liquid-oxygen venting, 56
 - restart capability, iii, 61, 131, 175, 216
 - visibility study, 32-33, 48, 54
- SA-201 (Saturn-Apollo 201), etc. See AS-201, etc., and AS-501, etc.
- Sacramento, Calif., 2, 61-62
- Saegesser, Lee D., xiv
- Saint Louis, Mo., 37
- Salyut 1*, 394-95
- San Diego Naval Air Station, 356
- Santa Barbara, Calif., 316
- Santa Cruz, Calif., 187
- Santa Monica, Calif., 61
- Sargent Industries, Airite Div., 252, 267
- Sasseen, George T., 101
- Saturn IB launch vehicle ("uprated Saturn I" May 12, 1966-Dec. 2, 1967), 48, 82
 - AS-201, 2, 10, 377
 - AS-202, 2, 37, 380**
 - AS-203, 2, 28, 379
 - AS-204 (Apollo 1 and *Apollo 5*), 97, 116, 130, 171, 196
 - AS-205 (*Apollo 7*), 117, 171, 257, 377
 - AS-206, 68-69, 76, 97, 162, 171, 229
 - AS-207, 6, 7, 12
 - contract, 32
 - mission designations, 100, 110, 127, 157, 200
 - name change, 22, 179
 - OMSF responsibility, 315
 - performance, 377, 379, 380, 384, 385
 - program on standby, 259
 - rendezvous (see also *Apollo 7*), 142
 - wind constraint, 251
- Saturn V launch vehicle (see also AS-500-F, AS-501, etc. and S-IB and S-IVB stages), iv, 82, 216 il., 255 il., 308 il.
 - A-J missions, 157
 - abort, 163, 254
 - bending loads, 232, 254
 - budget, 150
 - design, 191, 232, 247
 - emergency detection system, 247
 - engine, 35 il., 43 il., 215, 222, 232, 247, 254
 - manning, 123, 179, 191
 - manual-control simulation, 33-34
 - OMSF responsibility, 315
 - performance, 61, 83, 217, 235, 249, 384, 386-89, 392, 394, 395, 397, 399
 - pogo effect, 215, 222, 233-34, 237, 241, 242, 244, 247, 254
 - program shift to Saturn V, 259
 - safety factors, 247
 - SM tank failure impact, 48
 - test flight program, iii, 182, 227
 - wind constraint, 251
- Saturn V 503 (see also AS-503 and *Apollo 8*), 242-44
- Saturn V 504 (see also AS-504 and *Apollo 9*), 243
- Saturn V 515, 326
- Saturn-Apollo Flight Evaluation Panel, 249
- Savage, Melvyn, 27
- Sawyer, R. W., 166
- Sayre, Francis B., 363
- Scheer, Julian, 16, 22, 100, 110
- Scherer, Lee R., 186, 187, 250-51, 327, 346
- Schirra, Walter M., Jr., 41, 53 il., 78, 116, 133, 231, 257-58 il.-59, 272, 374, 385, 408
- Schmitt, Harrison H., 138, 357-59 il.-60, 376, 399-400, 408-09
- Schneider, William C., 173, 218, 236, 239, 247, 254, 257, 259, 315
- Schweickart, Russell L., 47, 56, 286-87, 289, 374, 387-88, 408
- Scientific and Technical Advisory Committee (STAC), 241
- Scientific instrument module (SIM). See SM (service module).
- Scientists' dissatisfaction, 323-24
- Scott, David R., 2, 12-13, 47, 56, 286-87 il., 289, 344 il., 347 il.-50, 374, 376, 377, 387, 395-96, 408-09
- Scout launch vehicle, 385, 393
- Seal Beach, Calif., 61
- Seamans, Robert C., Jr., 2, 3, 13, 15-17, 20, 22, 28, 30-31, 39, 46, 50-51, 55, 63, 65, 68-69, 75-79, 80, 83, 132, 136, 140, 148, 150, 162, 165
- Seattle, Wash., 316
- Sebring, Paul B., 5
- Secondary life support system (SLSS), 315, 317-18, 327
- Seiff, Alvin, 161
- Seitz, Frederick, 151
- Semmes, B. J., Jr., 298
- Senior Flammability Review Board, 116, 121, 193, 201-02, 203, 209
- Service module. See SM.
- Service propulsion system (SPS). See SM.
- Sevastyanov, Vitaly I., 392
- Sevier, John R., 157
- Shapley, Willis B., 55, 179
- Shatalov, Vladimir A., 387, 390, 394
- Shea, Joseph F.
 - ASPO Manager, 6, 11, 12, 19-21, 24-27, 29-31, 38-39, 41-44, 47-49, 53-54, 59-60, 63, 70, 74-75, 77-78, 109, 119
 - NASA Deputy Associate Administrator for Manned Space Flight, 119
- Shepard, Alan B., Jr., 338 il., 340 il., 341-43 il., 373, 375, 394, 409
- Shepherd, James T., 345
- Sheridan, Robert B., 318
- Shinkle, John G., 44, 47-48, 71
- Shonin, Georgy S., 390
- Sieppert, Albert F., 71
- Silveira, Milton A., 169

INDEX

- Simpkinson, Scott H., 71, 73, 126, 163, 167, 174, 214, 226, 317, 328, 336, 337, 356
- Simulators (see also Lunar Landing Research Facility, Lunar landing research vehicle, and Lunar landing training vehicle), 39, 51 il., 72, 288
- Ames Research Center flight simulator, 33-34
 - Apollo Mission (AMS), 38, 128, 147, 159-60, 197 il., 246
 - command module. See CM, mockups.
 - computers, 33, 40, 53, 288
 - Configuration Control Panel, 159
 - Dynamic Crew Procedure Simulator, 203
 - helicopter, 55
 - large space environment, 13 il., 39-40, 143, 195, 270-71, 273, 326 il.
 - launch vehicle, 33-34, 120
 - LM, 9, 15, 32-33, 40, 53, 56, 146
 - Lunar Orbit and Landing Approach (LOLA), 15
 - lunar roving vehicle, 338
 - 1/6-g, 11 il., 290
 - partial gravity, 316
 - Rendezvous Docking, 74
 - zero-g, 54
- Sjoberg, Sigurd A., 123, 220, 302-03, 316, 325, 351
- Sjogren, William L., 293
- Skylab program, iii, v-vi, 346, 356
- SLA (spacecraft-lunar module adapter), 5, 30, 37, 78, 134, 146-47, 153 il., 175, 190
- SLA-9, 207
- SLA-101, 175
- Slayton, Donald K. ("Deke"), 5, 6, 10, 19, 25, 29, 30, 38-39, 52-54, 56-58, 60, 78, 88, 144, 145, 147, 158-60, 164, 170, 171, 180, 188, 193, 201, 207-08, 218, 224, 231, 238-41, 246, 256, 268, 274-75, 298, 300, 314, 316, 323, 325
- SM (service module), iv, 82, 330 il., 339 il.
- Block II, 25, 208, 248 il.
 - experiment hardware, 18, 25, 37
 - explosion. See *Apollo 13*.
 - modifications, 25, 328
 - reaction control system (RCS) 36, 46, 58, 166-67, 177-78, 206, 211, 230
 - scientific instrument module (SIM), v, 25, 328, 349 il.-50, 353 il., 355 il., 356, 358, 360, 396, 399
 - service propulsion system (SPS), iv, 2, 12, 14, 19, 110, 193-94, 208, 209, 212-13, 216, 220, 231, 258, 268, 271, 272, 276-77, 298, 307
- SM 011, 19
- SM 012, 75, 77, 87-88
- SM 017 propellant tank failure, 48-49, 109
- SM 020, 211
- SM 101, 48, 166-67, 179, 193-94, 208, 230
- SM 102, 179, 191, 193-94, 208
- SM 105, 227
- SM 111, 219
- Smith, Arlin G., 267
- Smith, Francis B., 55
- Smith, Hinchman & Grylls, 32
- Smith, R. L., 313
- Smith, Richard G., 338, 344, 351
- Smylie, Robert E., 195
- SNAP-27. See *Apollo Lunar Surface Experiment Package*, radioisotope thermoelectric generator.
- Snedeker, John C., 14
- Snyder, Conway W., 9
- Software Review Board, 203-04
- Software Task Force, 117, 185, 204, 250
- Sonett, Charles P., 9
- Source Evaluation Board, 13, 18, 132
- Soyuz 1* through *11*, 382-95
- Space Environment Simulation Laboratory. See *Manned Spacecraft Center*.
- Space program
- objectives, vii, 40, 323-24, 329
 - scientists and, 323-24
 - trends, 340
- Space rescue, 21, 53-54, 59
- Space Science Steering Committee, 39, 130
- Planetary Biology Subcommittee, 39
- Space Shuttle program, vi, 293, 324
- Space Shuttle Task Group, 293
- Space station, 40, 324
- Space Task Group (MSC forerunner), 351
- Space Task Group, President's, 293, 324
- Space treaty, 63
- Space Window, 265, 363 il.
- Spacecraft-lunar module adapter. See SLA.
- Spacecraft reentry, uncontrolled, 208
- Spacesuit, 345 il.
- A7L suit modifications, 315
 - A9L suit procurement, 282
 - Apollo Block I, 18
 - Apollo Block II, 58, 106, 145, 150, 232, 345 il.
 - constant-wear garment, 18, 173-74
 - dust problem, 323
 - failure, 76, 98, 106, 109, 144, 145
 - integrity, 144, 147, 323
 - mobility, 226-27, 315, 345 il.
 - pressure suit, 11, 338, 345 il.
 - review, 232-33, 274
 - test, 72, 81, 150
- Special Task Team for Spacecraft 103 Contamination Control, 195, 198-99
- Speer, Fridtjof A., 235-36, 322
- Spider*. See *Apollo 9* and LM-9.
- Stafford, Thomas P., 42, 56, 133, 291, 296-98, 374, 378, 388, 408
- Stahl, Cdr. Charles J. (USN), 63
- Stanford University, 9
- Stern, Eric, 122
- Stevenson, John D., 182, 203, 208, 225, 250, 282
- Stewart, William, 28
- Steyer, Wesley A., 194
- Stoner, George H., 159, 178, 201
- Stoney, William E., Jr., 6, 62, 312, 325
- Stoops, Gordon J., 74, 133
- Strang, Col. Charles F. (USAF), 64, 65, 66, 68, 71, 74
- Strickland, Arthur T., 5
- Structures Advisory Board, 269
- Stuhlinger, Ernst, 47, 182, 251, 324
- Sunnyvale, Calif., 37
- Super Guppy* (transport aircraft), 35
- Surveyor I*, 2, 24, 34, 36, 300, 378
- Surveyor II*, 40, 380
- Surveyor III* (*Surveyor C*), v, 102, 141, 264, 300, 315, 318, 320 il., 321, 382, 391
- Surveyor IV*, 141, 384
- Surveyor V*, 383
- Surveyor VI*, 383
- Surveyor VII*, 311, 384

INDEX

Surveyor program, 36, 40, 148
 Sutton, George, 9
 Swieda, Ernest, 71
 Swigert, John L., Jr., 329, 330 il., 375, 392, 408-09

T

Taeuber, Ralph J., 166, 190-91
 Talbert, Rexford H., 143
 Taylor, Clinton L., 23
 Taylor, James J., 187
 Taylor, William H., 195
 Teir, William, 75, 253
 Television, 50-51, 134, 356, 363
 CM, 15-17, 25, 50-51, 117, 168-69, 218, 258-59,
 264, 273, 275-77, 296-98, 302, 306, 319-22,
 329, 341-42, 348, 385
 color, 264, 296-98, 302, 306-07, 319, 348
 LM, 25, 168-69, 273, 277, 286, 306, 319-30, 348
 lunar surface, 15-17, 24, 50, 265, 309, 340-41, 349,
 354
 Thibodaux, Joseph G., Jr., 48, 158, 231
 Thompson, Floyd L., 6, 11, 19, 33, 42
 Chairman, Apollo 204 Review Board, 3, 63, 66,
 67, 71, 73, 75, 77-80, 97, 101, 128, 133, 136
 Thor-Delta launch vehicle, 383
 Tindall, Howard W., Jr., 7, 179-80, 191-92, 217, 236,
 241, 255, 278
 Titan II Launch vehicle, 377-81
 Titterton, George F., 27, 41, 134
 Tracking ships, 44
 Trimble, George S., Jr., 163-64, 205, 275, 301, 323
 Tripp, Ralph H., 256, 277, 328
 Trott, Jack, 177
 Truszynski, Gerald M., 40
 TRW Inc., 185, 203-04
 Systems Div., 206
 Turnock, James H., 182, 251

U

Udall, Stewart L., 151
 United Kingdom, 63
 United Nations General Assembly, 63
 United States Space Week, 265, 364
 Universal Studios, 363
 University of Houston, 26
 University of Maryland, 130
 U.S. Air Force, 71, 78, 148, 213
 Bioastronautic Operational Support Unit, 63, 78
 Brooks AFB, Tex., 66, 68
 Eastern Test Range, 66, 70, 150, 170
 Ellington, AFB, Tex., 19
 Manned Orbiting Laboratory Systems Program Of-
 fice, 128, 220
 Norton, AFB, Calif., 225
 Space and Missile Systems Organization (SAMSO),
 311
 space rescue studies, 21
 Space Systems Div., 128
 Systems Command, AFSC, 21
 Wright-Patterson AFB, Ohio, 101, 220
 U.S. Army, 63

U.S. Congress, iii, 20, 140, 205
 Apollo 204 fire, 72, 80, 110-11, 125, 131, 157
 Apollo program costs, 2, 16, 289, 338
 House Committee on Science and Astronautics, 16,
 81-83, 131, 157, 289, 335
 Subcommittee on NASA Oversight, 110-11,
 131, 157
 Senate, 16, 319
 Committee on Aeronautical and Space Sci-
 ences, 72, 80, 110-11, 131, 157, 340, 362
 U.S. Geological Survey, 9, 35, 322
 U.S. Navy, 63, 78, 173 il., 298
 Navy Deputy Commander for Ship Acquisitions, 44
 San Diego Naval Air Station, 356
 U.S. Public Health Service, 28
 USNS *Mercury* (tracking ship), 44
 USNS *Redstone*, 44
 USNS *Vanguard*, 44
 U.S.S. *Bennington* (recovery ship), 172, 173 il.
 U.S.S. *Essex*, 258 il., 259
 U.S.S. *Guadalcanal*, 281, 287
 U.S.S. *Hornet*, 37, 303, 304, 308-09
 U.S.S. *Iwo Jima*, 332
 U.S.S. *Mason*, 13
 U.S.S. *New Orleans*, 342
 U.S.S. *Okinawa*, 216, 350
 U.S.S. *Princeton*, 298
 U.S.S. *Ticonderoga*, 337, 360, 399, 400
 U.S.S. *Yorktown*, 277
 U.S.S.R. (see also Luna, Salyut, and Soyuz), 63, 340

V

Van Dolah, Robert W., 65, 69, 73, 75, 76, 78, 97, 219
 Vaughn, N., 74
 Vavra, Paul H., 261
 Vecchietti, George J., 24
 Vehicle Assembly Building. See Kennedy Space Center.
 Vienna, Austria, 238-39
 Vincze, John, 190
 Vitagliano, H. Douglas, 146
 Volkov, Vladislav N., 390, 395
 Volynov, Boris V., 387
 von Braun, Werner, 30, 46-47, 125, 146, 148-49, 176,
 178, 238-39, 281, 299, 323-24, 346 il.

W

Wade, Donald C., 222
 Wagner, R. L., 27, 283
 Wake Island, 37
 Walker, Thomas J., III, 356
 Walton, Bruce H., 59
 Wardell, Anthony W., 132-33, 136
 Warren, Dickie K., 408-09
 Warzecha, Ladislaus, 176
 Wash, Michael R., 408-09
 Washington Cathedral Space Window, 265, 363 il.
 Washington, D.C., 15, 63, 78, 79, 148, 187, 239, 265,
 350, 361
 Watkins, Allen H., 48
 Watkins, J. S., 9
 Weaver, Charles H., 36

INDEX

- Webb, James E., 3, 13, 16, 20, 56, 57, 68, 76, 78, 79,
 110, 131, 132, 140, 150, 151, 164, 175-79, 185, 194,
 222, 238-41, 248
 Wedun, A. G., 261
 Weissman, Don, 138
 Weitz, Paul J., 408
 West, Julian M., 213
 West, Robert B., 169
 West Point, N.Y., 67
 Western Operations Office, 9
 Western Ways, Inc., 199-200
 Westinghouse Electric Corp., 36, 372
 Aerospace Div., 36
 Atomic Defense and Space Group, 36
 Wetter, C. F., 245
 White, Edward H., II, iii, 2, 47, 63, 67, 68, 100, 112
 White, George C., Jr., 64, 73, 126-28, 133, 170
 White, Hugh D., 48
 White, Lyle D., 226
 White, Maynard E., 174
 White House, 287, 329
 White Sands Missile Range (WSMR), New Mex., 20,
 78
 White Sands Test Facility (WSTF), 2, 8, 12, 48, 87,
 109, 116, 145, 188-89, 197, 225, 270
 Whitten, James B., 225
 Williams, Clifton C., Jr., 56
 Williams, John J., 64-66, 73-74
 Williams, Robert W., 25, 73, 83, 134, 144
 Williams, W., 71
 Williamson, David, Jr., 78
 Willoughby, Willis Jr., 87
 Wilmarth, Verl L., 165
 Wilson, T. A., 240
 Wise, Donald U., 262
 Witherington, Guy N., 102
 Woomera, Australia, 150
 Worden, Alfred N., 195, 344 il., 347-50, 376, 395, 408
 World records. See *Fédération Aéronautique Interna-
 tionale*.
 Wright-Patterson AFB, Ohio, 101, 220
 Wydler, Congressman John W., 81
 Wyle Laboratories, 241

X Y Z

- Yale University, 9
Yankee Clipper. See *Apollo 12* and CSM 108.
 Yardley, John F., 65-66, 70
 Yeamans, Fred, 219
 Yeliseyev, Aleksey S., 387, 390, 394
 Young, Earle B., 261
 Young, John W., 56, 133, 291, 352-53 il., 373, 374,
 376, 388, 397-98, 408-09
 Young, R. Wayne, 122
 Yscheck, Henry P., 26

THE AUTHORS

Ivan D. Ertel has been a contract historian to NASA's History Office since November 1972. He retired from NASA's Johnson Space Center in June 1972 after serving as the Center's Assistant Historian since September 1964. Born in Marion, New York (1914), he received his B.B.A. degree from Georgia State University, Atlanta, Georgia (1958). He was news editor of *Atlanta's Suburban Reporter*, East Point, Georgia, and the *Decatur-De Kalb News*, Decatur, Georgia (1954–1957). Before coming to NASA in 1961, he was Press Officer at Headquarters, Third U.S. Army. Ertel established the Manned Spacecraft Center's official news organ, *Space News Roundup*, authored fact sheets and brochures about each Mercury and Gemini manned flight, and is coauthor of *The Apollo Spacecraft: A Chronology*, Volume I (1969) and Volume III (1976), and *Skylab: A Chronology* (1977).

Roland W. Newkirk was born in Palenville, New York (1915). Following retirement from the Army and before joining NASA at the Johnson Space Center in 1965, Newkirk received his B.A. in history at the College of the Ozarks (1963) and his M.A. at the University of Arkansas (1965). He has also done graduate work in political science (public administration) at the University of Houston (1966–1970). Newkirk left the NASA Johnson Space Center in June 1973. He then served as a NASA contract historian for a short period. He authored *Skylab: Preliminary Chronology*, NASA HHN-130, May 1973, and is coauthor of *Skylab: A Chronology* (1977).

Courtney G. Brooks was a Research Associate in the History Department of the University of Houston from 1969 to 1974. In that capacity he coauthored the NASA-sponsored history of the development of the Apollo spacecraft, now in final revision, and *Skylab: A Chronology* (1977). Born in Savannah, Georgia (1939), he received his B.A. degree from Huntingdon College, Montgomery, Alabama (1964), and his M.A. (1966) and Ph.D. (1969) degrees in history from Tulane University, New Orleans, Louisiana.

THE NASA HISTORY SERIES

HISTORIES

- Anderson, Frank W., Jr., *Orders of Magnitude: A History of NACA and NASA, 1915-1976*, NASA SP-4403, 1976, GPO.*
- Benson, Charles D., and William Barnaby Faherty, *Moonport: A History of Apollo Launch Facilities and Operations*, NASA SP-4204, 1978, GPO.
- Byers, Bruce K., *Destination Moon: A History of the Lunar Orbiter Program*, NASA TM X-3487, 1977, NTIS.†
- Corliss, William R., *NASA Sounding Rockets, 1958-1968: A Historical Summary*, NASA SP-4401, 1971, NTIS.
- Ezell, Edward C. and Linda N., *The Partnership: A History of the Apollo-Soyuz Test Project*, NASA SP-4209, 1978, GPO.
- Green, Constance McL., and Milton Lomask, *Vanguard: A History*, NASA SP-4202, 1970, GPO; also Washington: Smithsonian Institution Press, 1971.
- Hacker, Barton C., and James M. Grimwood, *On the Shoulders of Titans: A History of Project Gemini*, NASA SP-4203, 1977, GPO.
- Hall, R. Cargill, *Lunar Impact: A History of Project Ranger*, NASA SP-4210, 1977, GPO.
- Hartman, Edwin P., *Adventures in Research: A History of the Ames Research Center, 1940-1965*, NASA SP-4302, 1970, NTIS.
- Link, Mae Mills, *Space Medicine in Project Mercury*, NASA SP-4003, 1965, NTIS.
- Rosholt, Robert L., *An Administrative History of NASA, 1958-1963*, NASA SP-4101, 1966, NTIS.
- Sloop, John L., *Liquid Hydrogen as a Propulsion Fuel, 1945-1959*, NASA SP-4404, 1978, GPO.
- Swenson, Loyd S., James M. Grimwood, and Charles C. Alexander, *This New Ocean: A History of Project Mercury*, NASA SP-4201, 1966, GPO.

REFERENCE WORKS

- Aeronautics and Space Report of the President*, annual volumes for 1975-1977, GPO.
- The Apollo Spacecraft: A Chronology*, NASA SP-4009: vol. 1, 1969, NTIS; vol. 2, 1973, GPO; vol. 3, 1976, GPO.
- Astronautics and Aeronautics: A Chronology of Science, Technology, and Policy*, annual volumes 1961-1974, with an earlier summary volume, *Aeronautics and Astronautics, 1915-1960*. Early volumes available from NTIS, recent ones from GPO.
- Hall, R. Cargill, ed., *Essays on the History of Rocketry and Astronautics: Proceedings of the Third through the Sixth History Symposia of the International Academy of Astronautics*, NASA CP-2014, 2 vols., 1977, GPO.
- Roland, Alex F., *A Guide to Research in NASA History*, HHR-50, 2d ed., Nov. 1977, looseleaf, available from NASA History Office.
- Skylab: A Chronology*, NASA SP-4011, 1977, GPO.
- Van Nimmen, Jane, and Leonard C. Bruno, *NASA Historical Data Book, 1958-1968*, NASA SP-4012, vol. 1, *NASA Resources*, 1976, NTIS.
- Wells, Helen T., Susan H. Whiteley, and Carrie E. Karegeannes, *Origins of NASA Names*, NASA SP-4402, 1976, GPO.

*GPO: Order from Superintendent of Documents, Government Printing Office, Washington, DC 20402.

†NTIS: Order from National Technical Information Service, Springfield, VA 22161.

